

DENTI, VOMERI, SOCS PER TILLER E VIBROCOLTIVATORI

TINES, SHARES, SOCS FOR TILLER OR CHISEL

DENTS, SOCS POUR TILLER AU CHISEL

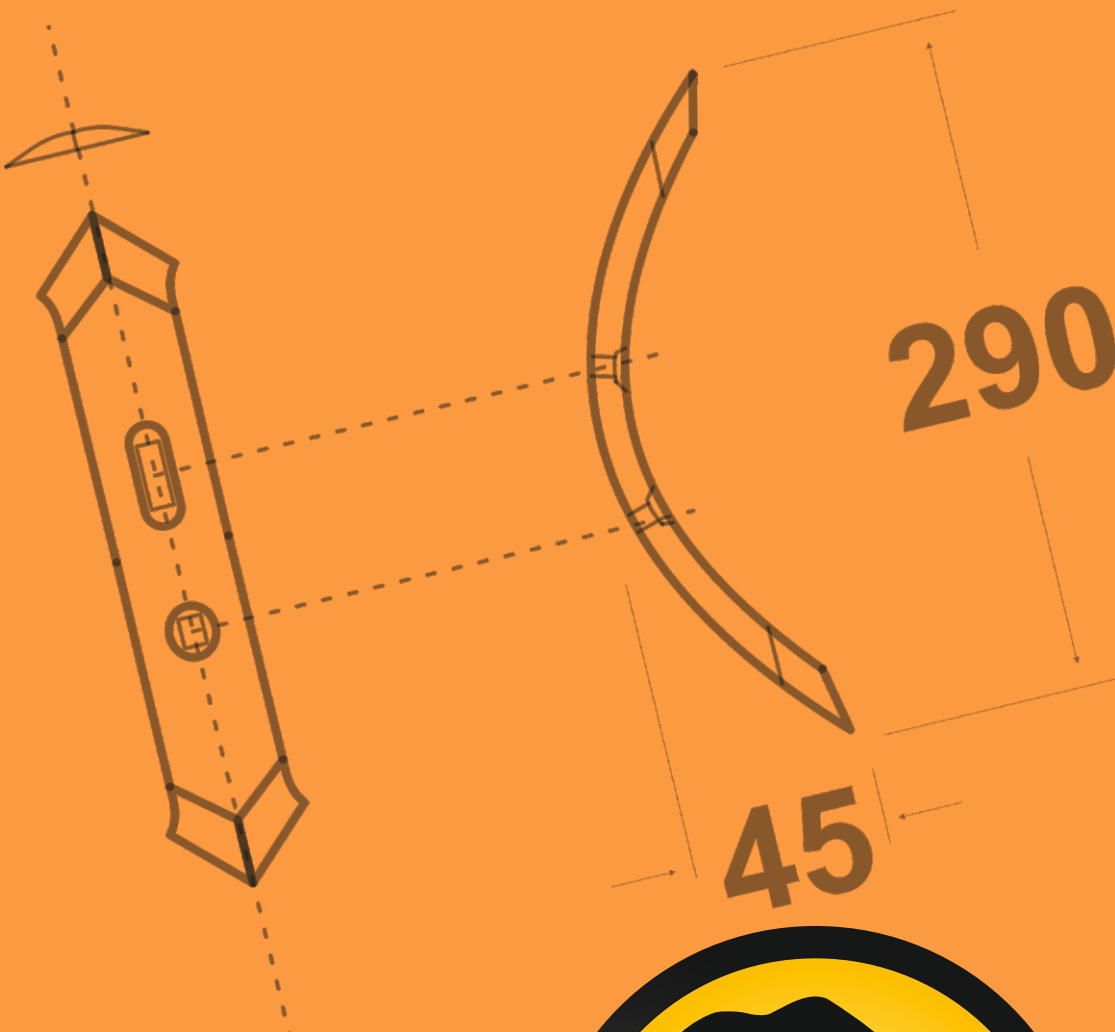





TILLER, SCHARE, GRUBBER - DIENTES, CHISEL PARA TILLER

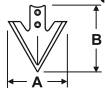

DENTI, VOMERI, SOCS PER TILLER E VIBROCOLTIVATORI



TINES, SHARES, SOCS FOR TILLER OR CHISEL
 DENTS, SOCS POUR TILLER AU CHISEL
 TILLER, SCHARE, GRUBBER - DIENTES, CHISEL PARA TILLER

Codice Ref. Re. Codigo	Marca e descrizione modello Brand name and model description Constructeur et description du modèle Marke und Modell Beschreibung Marca y modelo de descripción	Quote/ Dimensions Abmessungen Dimensiones (mm) 	Piatto Plate Platte Plaque 	Curvatura Curvature Corbure Krummung 	Foro Hole Trou Locher Hoyos Ø (mm) 	Interasse Cent. Distance Achsenabstand Distancia entre ejes 	Peso Weight Gewicht Poids 
------------------------	--	---	---	--	--	---	---

AGRIM

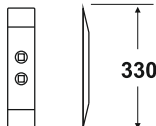
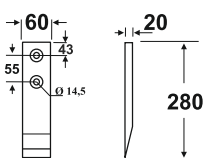
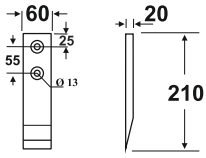
ZAGI01	VOMERINO F 700		70 X 20	D	14.5	55	3100
ZAGI02	VOMERINO		60 X 20	D	14.5	55	2400
ZAGI03	VOMERINO		60 X 20	D	13	55	1880

ALPEGO

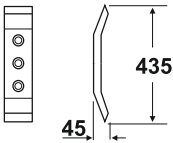
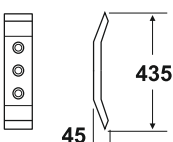
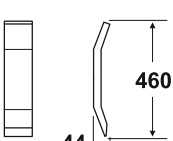
ZALP04	RIPUNTATORE 3 FORI		70 X 18	D	13	66 - 66	4200
ZALP07	VOMERE KD Cod Orig: 0980		70 X 15	D	13	66 - 66	4000
ZALP10	VOMERE RAPIDO KF Cod Orig: D05876		70 X 20	D	-	-	4080

ANGELONI

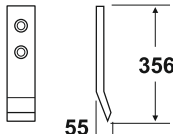



ZANG01	SCALPELLO		70 X 15	D	13	131	2600
--------	-----------	---	---------	---	----	-----	------

Tutti gli articoli sono di nostra produzione e non originali. Pesi e misure sono puramente indicativi e possono essere modificati senza preavviso. La riproduzione anche parziale del presente catalogo è vietata. All articles are of our production and not original. Weights and measures are approximate and may change without notice. Reproduction of this catalog is prohibited. Tous les articles sont fabriqués par nous-mêmes et non d'origine. Les poids et mesures sont approximatifs et peuvent changer sans préavis. Alle artikel werden von uns selbst hergestellt und nicht original. Masse und gewichte sind richtwerte und kan ohne vorank undigung gendert werden.

DENTI, VOMERI, SOCS PER TILLER E VIBROCOLTIVATORI

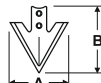

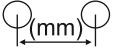
TINES, SHARES, SOCS FOR TILLER OR CHISEL
 DENTS, SOCS POUR TILLER AU CHISEL
 TILLER, SCHARE, GRUBBER - DIENTES, CHISEL PARA TILLER

Codice Ref. Re. Codigo	Marca e descrizione modello Brand name and model description Constructeur et description du modèle Marke und Modell Beschreibung Marca y modelo de descripción	Quote/ Dimensions Abmessungen Dimensiones (mm) 	Piatto Plate Platte Plaque 	Curvatura Curvature Corbure Krummung 	Foro Hole Trou Locher Hoyos Ø (mm)	Interasse Cent. Distance Achsenabstand Distancia entre ejes 	Peso Weight Gewicht Poids 
------------------------	--	---	---	--	---	---	---

ANGELONI

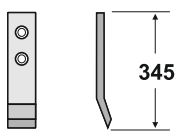
ZANG02	SCALPELLO		70 X 20	D	13	135	3200
--------	-----------	---	---------	---	----	-----	------

BADALINI

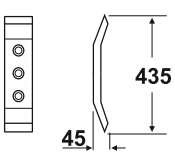
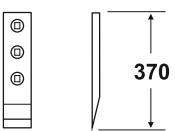
ZBAD14	RIPUNTATORE 3 FORI		70 X 18	D	13	66 - 66	4300
ZBAD16	VOMERE		70 X 18	D	13	65	3500

CONTERNO & OCCELLI

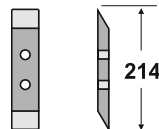
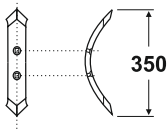
PCEO01	PUNTA REVERSIBILE		50 X 12	D	10.5	50	900
V064	PUNTALE RIPUNTATORE		60 X 15	-	13	50	2150

DONDI

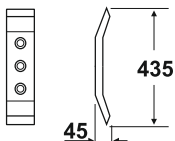



ZDON14	DRAG DENTE 3 FORI Cod Orig: 3814		70 X 18	D	13	66 - 66	4200
--------	--	---	---------	---	----	---------	------

Tutti gli articoli sono di nostra produzione e non originali. Pesi e misure sono puramente indicativi e possono essere modificati senza preavviso. La riproduzione anche parziale del presente catalogo è vietata. All articles are of our production and not original. Weights and measures are approximate and may change without notice. Reproduction of this catalog is prohibited. Tous les articles sont fabriqués par nous-mêmes et non d'origine. Les poids et mesures sont approximatifs et peuvent changer sans préavis. Alle artikel werden von uns selbst hergestellt und nicht original. Masse und gewichte sind richtwerte und kan ohne vorank undigung gendert werden.

DENTI, VOMERI, SOCS PER TILLER E VIBROCOLTIVATORI

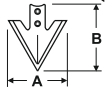

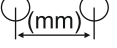
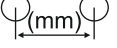
TINES, SHARES, SOCS FOR TILLER OR CHISEL
 DENTS, SOCS POUR TILLER AU CHISEL
 TILLER, SCHARE, GRUBBER - DIENTES, CHISEL PARA TILLER

Codice Ref. Re. Codigo	Marca e descrizione modello Brand name and model description Constructeur et description du modèle Marke und Modell Beschreibung Marca y modelo de descripción	Quote/ Dimensions Abmessungen Dimensiones (mm) 	Piatto Plate Platte Plaque 	Curvatura Curvature Corbure Krummung 	Foro Hole Trou Locher Hoyos Ø (mm) 	Interasse Cent. Distance Achsenabstand Distancia entre ejes 	Peso Weight Gewicht Poids 
------------------------	--	---	---	--	--	---	---

KONGSKILDE

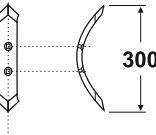
V058	SOC REVERSIBILE K 32		80 X 8	-	13	42	1400
------	-------------------------	---	--------	---	----	----	------

MAAG

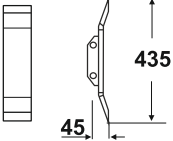
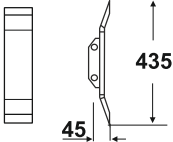
ZMAA01	PUNTA ANCORA 31		70 X 18	D	16	100	5070
ZMAA02	PUNTA ANCORA 35		70 X 18	D	16	100	4200

NARDI

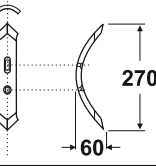
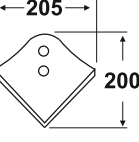
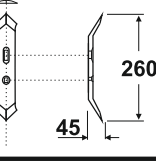
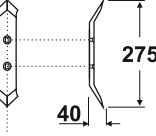



V001	VOMERE DOPPIA PUNTA BOMBATO		60 X 8	-	13	40 - 55	870
V015	TILLER		200 X 8	-	13	50	1200
V039	VOMERINO DOPPIA PUNTA Cod Orig: 33868000		50 X 10	-	13	40 - 55	1000
V056	SOC REVERSIBILE		50 X 12	-	13	50	1000

Tutti gli articoli sono di nostra produzione e non originali. Pesi e misure sono puramente indicativi e possono essere modificati senza preavviso. La riproduzione anche parziale del presente catalogo è vietata. All articles are of our production and not original. Weights and measures are approximate and may change without notice. Reproduction of this catalog is prohibited. Tous les articles sont fabriqués par nous-mêmes et non d'origine. Les poids et mesures sont approximatifs et peuvent changer sans préavis. Alle artikel werden von uns selbst hergestellt und nicht original. Masse und gewichte sind richtwerte und kan ohne vorank undigung gendert werden.

DENTI, VOMERI, SOCS PER TILLER E VIBROCOLTIVATORI

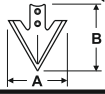

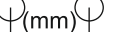
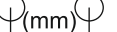
TINES, SHARES, SOCS FOR TILLER OR CHISEL
 DENTS, SOCS POUR TILLER AU CHISEL
 TILLER, SCHARE, GRUBBER - DIENTES, CHISEL PARA TILLER

Codice Ref. Re. Codigo	Marca e descrizione modello Brand name and model description Constructeur et description du modèle Marke und Modell Beschreibung Marca y modelo de descripción	Quote/ Dimensions Abmessungen Dimensiones (mm) 	Piatto Plate Platte Plaque 	Curvatura Curvature Corbure Krummung 	Foro Hole Trou Locher Hoyos Ø (mm) 	Interasse Cent. Distance Achsenabstand Distancia entre ejes 	Peso Weight Gewicht Poids 
------------------------	--	---	---	--	--	---	---

PEGORARO

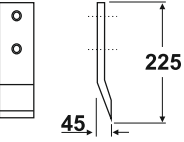
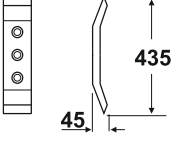
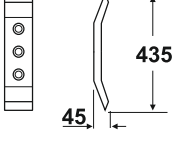
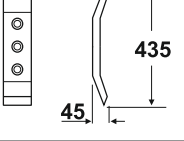
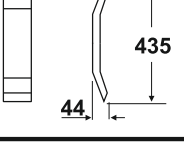
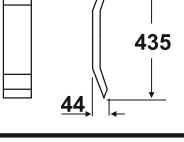
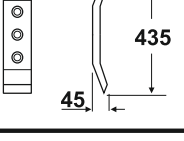
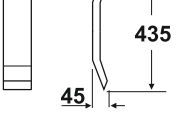





ZPEG03	VOMERE ANCORA		70 X 18	D	13	66	2200
ZPEG08	DRAG DENTE 3 FORI Cod Orig: 8342		70 X 14	D	13	66 - 66	3200
ZPEG09	DRAG DENTE 3 FORI Cod Orig: 3814		70 X 18	D	13	66 - 66	4200
ZPEG14	DRAG DENTE 3 FORI Cod Orig: 3715		100 X 14	D	13	66 - 66	4900
ZPEG15	RIP SENZA FORI RINFORZATO		70 X 20	D	-	-	4660
ZPEG15R	RIP SENZA FORI RINFORZATO CON RIPOSTO AL TUNGSTENO		70 X 20	D	-	-	4800
ZPEG16	DRAG DENTE 3 FORI		70 X 20	D	13	66 - 66	4500
ZPEG17	DRAG DENTE		70 X 18	D	-	-	4100

Tutti gli articoli sono di nostra produzione e non originali. Pesi e misure sono puramente indicativi e possono essere modificati senza preavviso. La riproduzione anche parziale del presente catalogo è vietata. All articles are of our production and not original. Weights and measures are approximate and may change without notice. Reproduction of this catalog is prohibited. Tous les articles sont fabriqués par nous-mêmes et non d'origine. Les poids et mesurent approximatifs et peuvent changer sans préavis. Alle artikel werden von uns selbst hergestellt und nicht original. Masse und gewichte sind richtwerte und kan ohne vorank undigung gendert werden.

DENTI, VOMERI, SOCS PER TILLER E VIBROCOLTIVATORI



TINES, SHARES, SOCS FOR TILLER OR CHISEL
 DENTS, SOCS POUR TILLER AU CHISEL
 TILLER, SCHARE, GRUBBER - DIENTES, CHISEL PARA TILLER

Codice Ref. Re. Codigo	Marca e descrizione modello Brand name and model description Constructeur et description du modèle Marke und Modell Beschreibung Marca y modelo de descripción	Quote/ Dimensions Abmessungen Dimensiones (mm) 	Piatto Plate Platte Plaque 	Curvatura Curvature Corbure Krummung 	Foro Hole Trou Locher Hoyos Ø (mm) 	Interasse Cent. Distance Achsenabstand Distancia entre ejes 	Peso Weight Gewicht Poids 
------------------------	--	---	---	--	--	---	---

RABEWERK

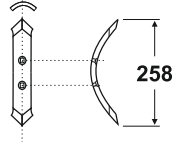
V005	DENTE REVERSIBILE BOMBATO		50 X 8	-	13	45	700
------	------------------------------	---	--------	---	----	----	-----

RAU

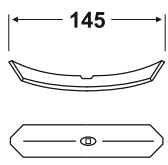
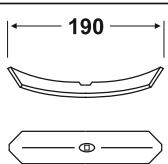
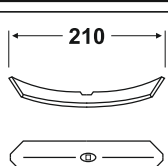
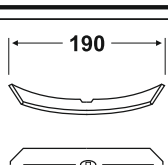
V004R	VOMERE VIBROFLEX		25 X 5	-	10.5	-	150
V019R	VOMERE VIBROFLEX		40 X 6	-	10.5	-	350
V023R	VOMERE VIBROFLEX		40 X 8	-	10.5	-	480
V024R	VOMERE VIBROFLEX		40 X 5	-	10.5	-	300

RENTER

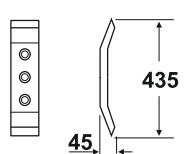





ZRNT01	RIPUNTATORE DENTE 3 FORI		70 X 18	D	13	66 - 66	4200
--------	--------------------------------	---	---------	---	----	---------	------

Tutti gli articoli sono di nostra produzione e non originali. Pesi e misure sono puramente indicativi e possono essere modificati senza preavviso. La riproduzione anche parziale del presente catalogo è vietata. All articles are of our production and not original. Weights and measures are approximate and may change without notice. Reproduction of this catalog is prohibited. Tous les articles sont fabriqués par nous-mêmes et non d'origine. Les poids et mesures sont approximatifs et peuvent changer sans préavis. Alle Artikel werden von uns selbst hergestellt und nicht original. Masse und Gewichte sind Richtwerte und können ohne Vorankündigung geändert werden.

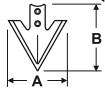
DENTI, VOMERI, SOCS PER TILLER E VIBROCOLTIVATORI



TINES, SHARES, SOCS FOR TILLER OR CHISEL
 DENTS, SOCS POUR TILLER AU CHISEL
 TILLER, SCHARE, GRUBBER - DIENTES, CHISEL PARA TILLER

Codice Ref. Re. Codigo	Marca e descrizione modello Brand name and model description Constructeur et description du modèle Marke und Modell Beschreibung Marca y modelo de descripción	Quote/ Dimensions Abmessungen Dimensiones (mm) 	Piatto Plate Platte Plaque 	Curvatura Curvature Corbure Krummung 	Foro Hole Trou Locher Hoyos Ø (mm) 	Interasse Cent. Distance Achsenabstand Distancia entre ejes 	Peso Weight Gewicht Poids 
------------------------	--	---	---	--	--	---	---

SICILTILLER

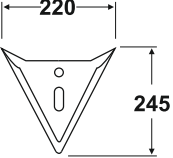
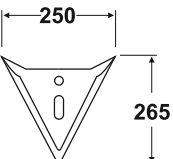
V012	TILLER STRETTO		7	-	13 x 13	40 - 55	2050
V013	TILLER LARGO		7	-	13 x 13	40 - 55	2750

SICMA

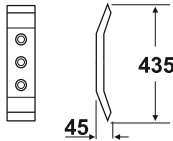
ZSIC23	RIPUNTATORE ROMPITRACCIA BRONTY		70 X 18	D	13	66 - 66	4200
--------	---------------------------------------	---	---------	---	----	---------	------

SOC

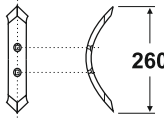
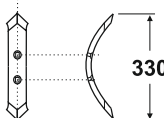
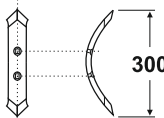



V002	VOMERE DOPPIA PUNTA TILLER MELCHIOR		30 X 12	-	11.5	50	1130
V003	VOMERE DOPPIA PUNTA		65 X 8	-	13	45	1300
V006	VOMERE DOPPIA PUNTA		55 X 15	-	13	45	1750

Tutti gli articoli sono di nostra produzione e non originali. Pesi e misure sono puramente indicativi e possono essere modificati senza preavviso. La riproduzione anche parziale del presente catalogo è vietata. All articles are of our production and not original. Weights and measures are approximate and may change without notice. Reproduction of this catalog is prohibited. Tous les articles sont fabriqués par nous-mêmes et non d'origine. Les poids et mesures sont approximatifs et peuvent changer sans préavis. Alle artikel werden von uns selbst hergestellt und nicht original. Masse und gewichte sind richtwerte und kan ohne vorank undigung gendert werden.

DENTI, VOMERI, SOCS PER TILLER E VIBROCOLTIVATORI

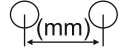
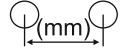

TINES, SHARES, SOCS FOR TILLER OR CHISEL
 DENTS, SOCS POUR TILLER AU CHISEL
 TILLER, SCHARE, GRUBBER - DIENTES, CHISEL PARA TILLER

Codice Ref. Re. Codigo	Marca e descrizione modello Brand name and model description Constructeur et description du modèle Marke und Modell Beschreibung Marca y modelo de descripción	Quote/ Dimensions Abmessungen Dimensiones (mm) 	Piatto Plate Platte Plaque 	Curvatura Curvature Corbure Krummung 	Foro Hole Trou Locher Hoyos Ø (mm) 	Interasse Cent. Distance Achsenabstand Distancia entre ejes 	Peso Weight Gewicht Poids 
------------------------	--	---	--	--	---	---	--

SOC

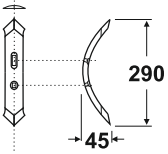
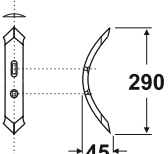
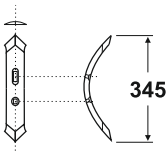
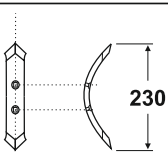
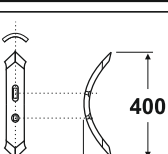
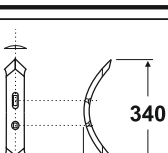
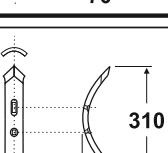
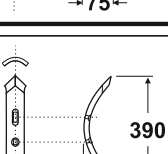



V007	VOMERE DOPPIA PUNTA		60 X 10	-	13	40 - 55	1250
V008	VOMERE DOPPIA PUNTA		60 X 12	-	13	40 - 55	1500
V009	VOMERE DOPPIA PUNTA		50 X 10	-	13	40 - 55	1250
V010	VOMERE DOPPIA PUNTA		50 X 8	-	10.5	45	790
V011	VOMERE DOPPIA PUNTA BOMBATO TIPO LAMEZIA		80 X 10	-	14.5	40 - 55	2100
V028	VOMERE DOPPIA PUNTA		60 X 10	-	13	40 - 55	1700
V029	VOMERE DOPPIA PUNTA BOMBATO		80 X 8	-	13	40 - 55	1600
V035	VOMERE DOPPIA PUNTA BOMBATO TIPO LAMEZIA		80 X 10	-	14.5	40 - 55	2070

Tutti gli articoli sono di nostra produzione e non originali. Pesi e misure sono puramente indicativi e possono essere modificati senza preavviso. La riproduzione anche parziale del presente catalogo è vietata. All articles are of our production and not original. Weights and measures are approximate and may change without notice. Reproduction of this catalog is prohibited. Tous les articles sont fabriqués par nous-même mes et non d'origine. Les poids et mesurés sont approximatifs et peuvent changer sans préavis. Alle artikel werden von uns selbst hergestellt und nicht original. Masse und gewichte sind richtwerte und kan ohne vorank undigung gendert werden.

DENTI, VOMERI, SOCS PER TILLER E VIBROCOLTIVATORI

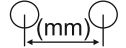

TINES, SHARES, SOCS FOR TILLER OR CHISEL
 DENTS, SOCS POUR TILLER AU CHISEL
 TILLER, SCHARE, GRUBBER - DIENTES, CHISEL PARA TILLER

Codice Ref. Re. Codigo	Marca e descrizione modello Brand name and model description Constructeur et description du modèle Marke und Modell Beschreibung Marca y modelo de descripción	Quote/ Dimensions Abmessungen Dimensiones (mm) 	Piatto Plate Platte Plaque 	Curvatura Curvature Corbure Krummung 	Foro Hole Trou Locher Hoyos Ø (mm)	Interasse Cent. Distance Achsenabstand Distancia entre ejes 	Peso Weight Gewicht Poids 
------------------------	--	---	---	--	---	---	---

SOC

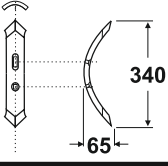
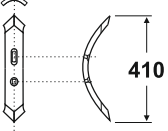
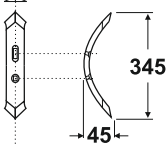
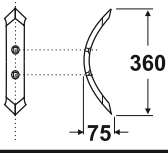
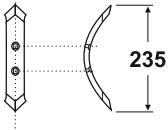
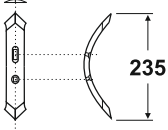
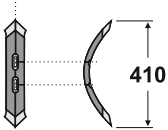
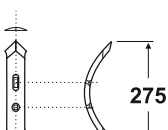





V036	VOMERE DOPPIA PUNTA BOMBATO TIPO LAMEZIA		60 X 10	-	14.5	40 - 55	1500
V038	VOMERE DOPPIA PUNTA BOMBATO		55 X 15	-	14.5	40 - 55	1640
V040	VOMERE DOPPIA PUNTA		60 X 15	-	13	40 - 55	2200
V041	VOMERE CHISEL DOPPIA PUNTA		55 X 15	-	15 X 15	60	2050
V051	VOMERE DOPPIA PUNTA		45 X 7	-	11.5	40	480
V052	VOMERE DOPPIA PUNTA		45 X 7	-	11.5	40 - 50	480
V054	CHISEL 2 ASOLE		55 X 15	-	13 X 34	-	2500
V055	VOMERE DOPPIA PUNTA		40 X 16	-	12.5	40 - 55	1250

Tutti gli articoli sono di nostra produzione e non originali. Pesi e misure sono puramente indicativi e possono essere modificati senza preavviso. La riproduzione anche parziale del presente catalogo è vietata. All articles are of our production and not original. Weights and measures are approximate and may change without notice. Reproduction of this catalog is prohibited. Tous les articles sont fabriqués par nous-mêmes et non d'origine. Les poids et mesurages sont approximatifs et peuvent changer sans préavis. Alle artikel werden von uns selbst hergestellt und nicht original. Masse und gewichte sind richtwerte und kan ohne vorank undigung gendert werden.

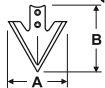
DENTI, VOMERI, SOCS PER TILLER E VIBROCOLTIVATORI



TINES, SHARES, SOCS FOR TILLER OR CHISEL
 DENTS, SOCS POUR TILLER AU CHISEL
 TILLER, SCHARE, GRUBBER - DIENTES, CHISEL PARA TILLER

Codice Ref. Re. Codigo	Marca e descrizione modello Brand name and model description Constructeur et description du modèle Marke und Modell Beschreibung Marca y modelo de descripción	Quote/ Dimensions Abmessungen Dimensiones (mm) 	Piatto Plate Platte Plaque 	Curvatura Curvature Corbure Krummung 	Foro Hole Trou Locher Hoyos Ø (mm) 	Interasse Cent. Distance Achsenabstand Distancia entre ejes 	Peso Weight Gewicht Poids 
---------------------------------	--	---	---	--	--	---	---

SOC

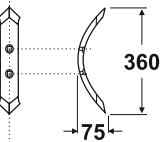
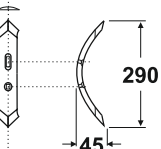
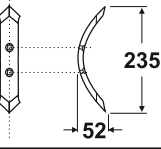
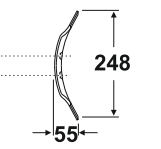
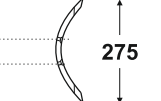
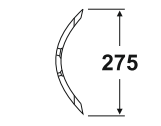
V068	CHISEL DOPPIA PUNTA		60 X 15	-	14.5	60	2550
V080	VOMERE DOPPIA PUNTA		50 X 12	-	13	40 - 55	1350
V081	VOMERE DOPPIA PUNTA		50 X 6	-	12.5	25	520
V116	VOMERINA REVERSIBILE BOMBATA		50 X 6	-	11 X 11	45	560
V117	VOMERINA		40 X 16	-	13 X 13	45	1250
V118	VOMERINA		55 X 15	-	13 X 13	45 - 50	1550

TILLER

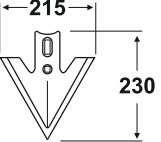



V030	VOMERE LANCIA		6	-	12.5	45 - 50	1150
------	------------------	---	---	---	------	---------	------

Tutti gli articoli sono di nostra produzione e non originali. Pesi e misure sono puramente indicativi e possono essere modificati senza preavviso. La riproduzione anche parziale del presente catalogo è vietata. All articles are of our production and not original. Weights and measures are approximate and may change without notice. Reproduction of this catalog is prohibited. Tous les articles sont fabriqués par nous-mêmes et non d'origine. Les poids et mesurent approximatifs et peuvent changer sans préavis. Alle artikel werden von uns selbst hergestellt und nicht original. Masse und gewichte sind richtwerte und kan ohne vorank undigung gendert werden.

DENTI, VOMERI, SOCS PER TILLER E VIBROCOLTIVATORI

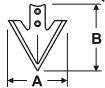

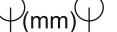
TINES, SHARES, SOCS FOR TILLER OR CHISEL
 DENTS, SOCS POUR TILLER AU CHISEL
 TILLER, SCHARE, GRUBBER - DIENTES, CHISEL PARA TILLER

Codice Ref. Re. Codigo	Marca e descrizione modello Brand name and model description Constructeur et description du modèle Marke und Modell Beschreibung Marca y modelo de descripción	Quote/ Dimensions Abmessungen Dimensiones (mm) 	Piatto Plate Platte Plaque 	Curvatura Curvature Corbure Krummung 	Foro Hole Trou Locher Hoyos Ø (mm)	Interasse Cent. Distance Achsenabstand Distancia entre ejes 	Peso Weight Gewicht Poids 
------------------------	--	---	--	--	--	---	--

TILLER

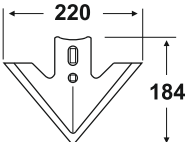
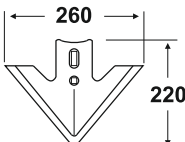
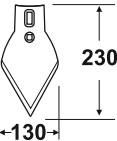
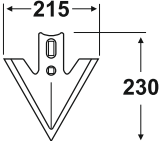
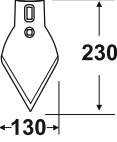
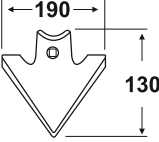
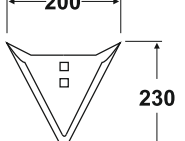
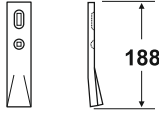





V031	VOMERE LANCIA SIRIA		6	-	12.5	45 - 50	1500
V032	VOMERE LANCIA		6	-	12.5	45 - 50	1280
V033	VOMERE TILLER CENTRALE		130 X 6	-	12.5	45 - 50	950
V037	VOMERE LANCIA TIPO PUGLIA		8	-	12.5	45 - 50	1560
V047	VOMERE TILLER CENTRALE PESANTE		130 X 8	-	12.5	45 - 50	1240
V049	VOMERE LANCIA		4	-	11	-	390
V050	TILLER RINCALZATORE		8	-	10.5	38	2050
V059	DRILL POINT		40 X 12	D	12.5	57 - 65	660

Tutti gli articoli sono di nostra produzione e non originali. Pesi e misure sono puramente indicativi e possono essere modificati senza preavviso. La riproduzione anche parziale del presente catalogo è vietata. All articles are of our production and not original. Weights and measures are approximate and may change without notice. Reproduction of this catalog is prohibited. Tous les articles sont fabriqués par nous-mêmes et non d'origine. Les poids et mesurés approximatifs et peuvent changer sans préavis. Alle artikel werden von uns selbst hergestellt und nicht original. Masse und gewichte sind richtwerte und kan ohne vorank undigung gendert werden.

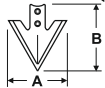
DENTI, VOMERI, SOCS PER TILLER E VIBROCOLTIVATORI



TINES, SHARES, SOCS FOR TILLER OR CHISEL
 DENTS, SOCS POUR TILLER AU CHISEL
 TILLER, SCHARE, GRUBBER - DIENTES, CHISEL PARA TILLER

Codice Ref. Re. Codigo	Marca e descrizione modello Brand name and model description Constructeur et description du modèle Marke und Modell Beschreibung Marca y modelo de descripción	Quote/ Dimensions Abmessungen Dimensiones (mm) 	Piatto Plate Platte Plaque 	Curvatura Curvature Corbure Krummung 	Foro Hole Trou Locher Hoyos Ø (mm) 	Interasse Cent. Distance Achsenabstand Distancia entre ejes 	Peso Weight Gewicht Poids 
------------------------	--	---	---	--	--	---	---

TILLER

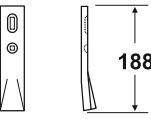
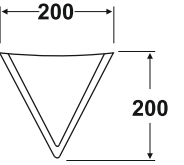
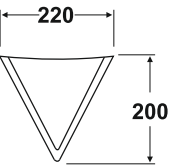
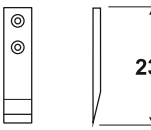
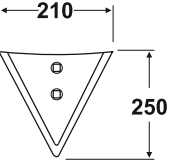
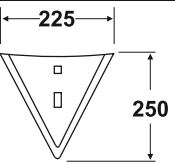
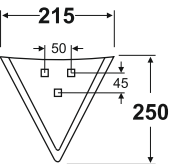
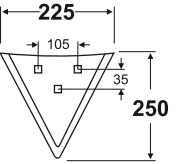



V060	DRILL POINT		40 X 16	D	12.5	57 - 65	930
V061	VOMERINA NON FORATA A SALDARE		5	-	-	-	1050
V062	VOMERINA NON FORATA A SALDARE		6	-	-	-	1260
V063	DENTE PIATTO		60 X 18	D	13	50	2000
V071	TILLER CANTARELLA		8	-	14.5	67	2010
V072	TILLER		8	-	13	38 - 50	2000
V073	TILLER DI RAIMONDO - OMA OCAPA		8	-	13	50	2050
V074	TILLER CANTARELLA		8	-	13	105	2090

Tutti gli articoli sono di nostra produzione e non originali. Pesi e misure sono puramente indicativi e possono essere modificati senza preavviso. La riproduzione anche parziale del presente catalogo è vietata. All articles are of our production and not original. Weights and measures are approximate and may change without notice. Reproduction of this catalog is prohibited. Tous les articles sont fabriqués par nous-mêmes et non d'origine. Les poids et mesures sont approximatifs et peuvent changer sans préavis. Alle artikel werden von uns selbst hergestellt und nicht original. Masse und gewichte sind richtwerte und kan ohne vorank undigung gendert werden.

DENTI, VOMERI, SOCS PER TILLER E VIBROCOLTIVATORI

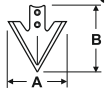

TINES, SHARES, SOCS FOR TILLER OR CHISEL
 DENTS, SOCS POUR TILLER AU CHISEL
 TILLER, SCHARE, GRUBBER - DIENTES, CHISEL PARA TILLER

Codice Ref. Re. Codigo	Marca e descrizione modello Brand name and model description Constructeur et description du modèle Marke und Modell Beschreibung Marca y modelo de descripción	Quote/ Dimensions Abmessungen Dimensiones (mm) 	Piatto Plate Platte Plaque 	Curvatura Curvature Corbure Krummung 	Foro Hole Trou Locher Hoyos Ø (mm)	Interasse Cent. Distance Achsenabstand Distancia entre ejes 	Peso Weight Gewicht Poids 
------------------------	--	---	--	--	--	---	--

TILLER

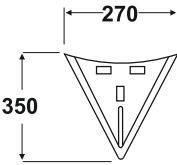
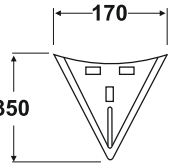
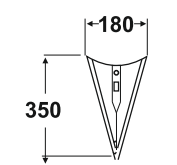
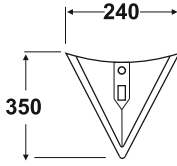
V084	TILLER 3 FORI TIPO ALCAMO		350 X 10	-	13 X 25	100	4040
V086	TILLER 3 FORI STRETTO TIPO ALCAMO		350 X 10	-	13 X 25	100	2280
V090	TILLER TIPO ASOLA		10	-	13	53-75	3630
V091	TILLER TIPO ASOLA STRETTO		10	-	13	53-75	3630
V093	TILLER TIPO CILIA		10	-	14.5	45	3100
V109	TILLER TIPO ASOLA MEDIO		10	-	13	53-75	3630

VIBROCOLTIVATORI

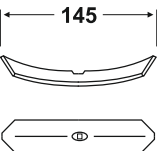





V004	VOMERE VIBROFLEX		25 X 5	-	10.5	-	150
------	---------------------	---	--------	---	------	---	-----

Tutti gli articoli sono di nostra produzione e non originali. Pesi e misure sono puramente indicativi e possono essere modificati senza preavviso. La riproduzione anche parziale del presente catalogo è vietata. All articles are of our production and not original. Weights and measures are approximate and may change without notice. Reproduction of this catalog is prohibited. Tous les articles sont fabriqués par nous-mêmes et non d'origine. Les poids et mesurent approximatifs et peuvent changer sans préavis. Alle artikel werden von uns selbst hergestellt und nicht original. Masse und gewichte sind richtwerte und kan ohne vorank undigung gendert werden.

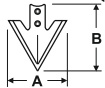
DENTI, VOMERI, SOCS PER TILLER E VIBROCOLTIVATORI



TINES, SHARES, SOCS FOR TILLER OR CHISEL
 DENTS, SOCS POUR TILLER AU CHISEL
 TILLER, SCHARE, GRUBBER - DIENTES, CHISEL PARA TILLER

Codice Ref. Re. Codigo	Marca e descrizione modello Brand name and model description Constructeur et description du modèle Marke und Modell Beschreibung Marca y modelo de descripción	Quote/ Dimensions Abmessungen Dimensiones (mm) 	Piatto Plate Platte Plaque 	Curvatura Curvature Corbure Krummung 	Foro Hole Trou Locher Hoyos Ø (mm) 	Interasse Cent. Distance Achsenabstand Distancia entre ejes 	Peso Weight Gewicht Poids 
------------------------	--	---	--	--	---	---	--

VIBROCOLTIVATORI

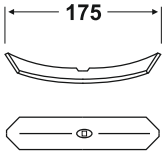
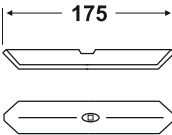
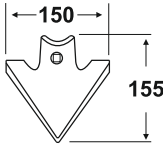
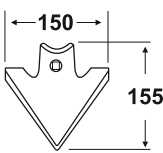
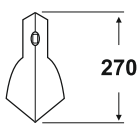
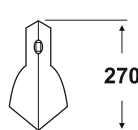
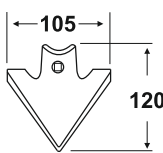
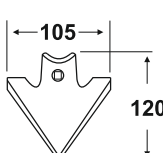



V014	VOMERE VIBROFLEX		25 X 5	-	10.5	-	160
V014D	VOMERINA VIBROFLEX DIRITTA		25 X 5	-	10.5	-	160
V016	VOMERINA VIBROFLEX		150 X 4	-	10.5	-	320
V016P	VOMERINA VIBROFLEX PESANTE		150 X 6	-	10.5	-	370
V017	VOMERINA VIBROFLEX		70 X 4	-	10.5	-	230
V017P	VOMERINA VIBROFLEX PESANTE		70 X 6	-	10.5	-	260
V018	VOMERINA VIBROFLEX		105 X 4	-	10.5	-	220
V018P	VOMERINA VIBROFLEX PESANTE		105 X 6	-	10.5	-	260

Tutti gli articoli sono di nostra produzione e non originali. Pesi e misure sono puramente indicativi e possono essere modificati senza preavviso. La riproduzione anche parziale del presente catalogo è vietata. All articles are of our production and not original. Weights and measures are approximate and may change without notice. Reproduction of this catalog is prohibited. Tous les articles sont fabriqués par nous-mêmes et non d'origine. Les poids et mesures sont approximatifs et peuvent changer sans préavis. Alle artikel werden von uns selbst hergestellt und nicht original. Masse und gewichte sind richtwerte und kan ohne vorank undigung gendert werden.

DENTI, VOMERI, SOCS PER TILLER E VIBROCOLTIVATORI

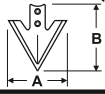

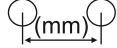
TINES, SHARES, SOCS FOR TILLER OR CHISEL
 DENTS, SOCS POUR TILLER AU CHISEL
 TILLER, SCHARE, GRUBBER - DIENTES, CHISEL PARA TILLER

Codice Ref. Re. Codigo	Marca e descrizione modello Brand name and model description Constructeur et description du modèle Marke und Modell Beschreibung Marca y modelo de descripción	Quote/ Dimensions Abmessungen Dimensiones (mm) 	Piatto Plate Platte Plaque 	Curvatura Curvature Corbure Krummung 	Foro Hole Trou Locher Hoyos Ø (mm)	Interasse Cent. Distance Achsenabstand Distancia entre ejes 	Peso Weight Gewicht Poids 
------------------------	--	---	--	--	--	---	--

VIBROCOLTIVATORI

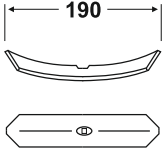
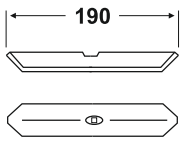
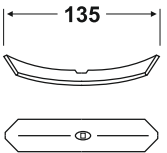
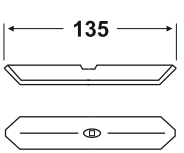
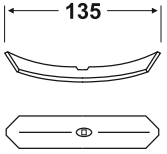
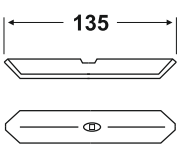
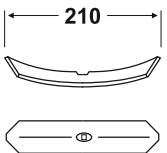
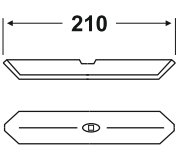



V019	VOMERINA VIBROFLEX		40 X 6	-	10.5	-	350
V019D	VOMERINA VIBROFLEX DIRITTA		40 X 6	-	10.5	-	350
V020	VOMERINA VIBROFLEX		40 X 5	-	10.5	-	250
V020D	VOMERINA VIBROFLEX DIRITTA		40 X 5	-	10.5	-	250
V021	VOMERINA VIBROFLEX		40 X 6	-	10.5	-	240
V021D	VOMERINA VIBROFLEX DIRITTA		40 X 6	-	10.5	-	240
V022	VOMERINA VIBROFLEX		40 X 6	-	10.5	-	400
V022D	VOMERINA VIBROFLEX DIRITTA		40 X 6	-	10.5	-	400

Tutti gli articoli sono di nostra produzione e non originali. Pesi e misure sono puramente indicativi e possono essere modificati senza preavviso. La riproduzione anche parziale del presente catalogo è vietata. All articles are of our production and not original. Weights and measures are approximate and may change without notice. Reproduction of this catalog is prohibited. Tous les articles sont fabriqués par nous-mêmes et non d'origine. Les poids et mesurent approximatifs et peuvent changer sans préavis. Alle artikel werden von uns selbst hergestellt und nicht original. Masse und gewichte sind richtwerte und kan ohne vorank undigung gendert werden.

DENTI, VOMERI, SOCS PER TILLER E VIBROCOLTIVATORI

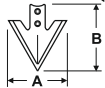

TINES, SHARES, SOCS FOR TILLER OR CHISEL
 DENTS, SOCS POUR TILLER AU CHISEL
 TILLER, SCHARE, GRUBBER - DIENTES, CHISEL PARA TILLER

Codice Ref. Re. Codigo	Marca e descrizione modello Brand name and model description Constructeur et description du modèle Marke und Modell Beschreibung Marca y modelo de descripción	Quote/ Dimensions Abmessungen Dimensiones (mm) 	Piatto Plate Platte Plaque 	Curvatura Curvature Corbure Krummung 	Foro Hole Trou Locher Hoyos Ø (mm)	Interasse Cent. Distance Achsenabstand Distancia entre ejes 	Peso Weight Gewicht Poids 
------------------------	--	---	--	--	--	---	--

VIBROCOLTIVATORI

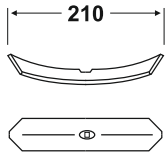
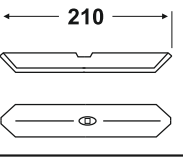
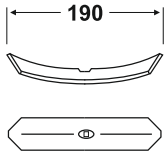
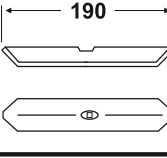
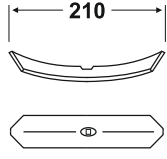
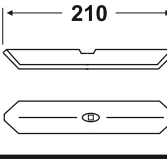
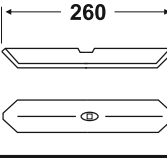
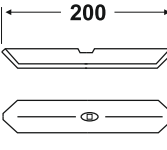



V023	VOMERINA VIBROFLEX		40 X 8	-	10.5	-	480
V023D	VOMERINA VIBROFLEX DIRITTA		40 X 8	-	10.5	-	480
V024	VOMERINA VIBROFLEX		40 X 5	-	10.5	-	300
V024D	VOMERINA VIBROFLEX DIRITTA		40 X 5	-	10.5	-	300
V025	VOMERINA VIBROFLEX		40 X 5	-	10.5	-	350
V025D	VOMERINA VIBROFLEX DIRITTA		40 X 5	-	10.5	-	350
V026	VOMERINA VIBROFLEX DIRITTA		40 X 8	-	10.5	-	500
V027	VOMERINA VIBROFLEX DIRITTA		40 X 6	-	10.5	-	350

Tutti gli articoli sono di nostra produzione e non originali. Pesi e misure sono puramente indicativi e possono essere modificati senza preavviso. La riproduzione anche parziale del presente catalogo è vietata. All articles are of our production and not original. Weights and measures are approximate and may change without notice. Reproduction of this catalog is prohibited. Tous les articles sont fabriqués par nous-mêmes et non d'origine. Les poids et mesurent approximatifs et peuvent changer sans préavis. Alle artikel werden von uns selbst hergestellt und nicht original. Masse und gewichte sind richtwerte und kan ohne vorank undigung gendert werden.

DENTI, VOMERI, SOCS PER TILLER E VIBROCOLTIVATORI

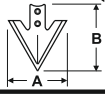

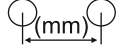
TINES, SHARES, SOCS FOR TILLER OR CHISEL
 DENTS, SOCS POUR TILLER AU CHISEL
 TILLER, SCHARE, GRUBBER - DIENTES, CHISEL PARA TILLER

Codice Ref. Re. Codigo	Marca e descrizione modello Brand name and model description Constructeur et description du modèle Marke und Modell Beschreibung Marca y modelo de descripción	Quote/ Dimensions Abmessungen Dimensiones (mm) 	Piatto Plate Platte Plaque 	Curvatura Curvature Corbure Krummung 	Foro Hole Trou Locher Hoyos Ø (mm)	Interasse Cent. Distance Achsenabstand Distancia entre ejes 	Peso Weight Gewicht Poids 
------------------------	--	---	--	--	--	---	--

VIBROCOLTIVATORI

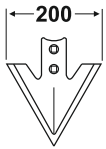
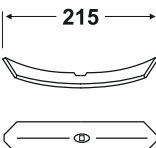
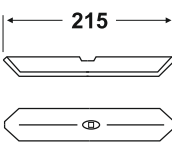
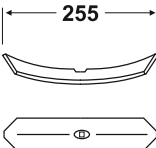
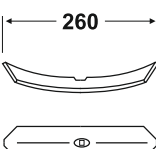
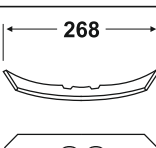
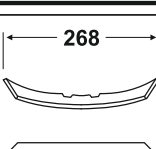
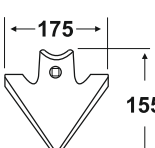



V034	VOMERINA LANCIA		200 X 6	-	10.5	30	1100
V042	VOMERINA VIBROFLEX		40 X 6	-	10.5	-	400
V042D	VOMERINA VIBROFLEX DIRITTA		40 X 6	-	10.5	-	400
V043	VOMERINA VIBROFLEX		50 X 8	-	10.5	-	600
V044	VOMERINA VIBROFLEX		60 X 6	-	10.5	-	650
V045	VOMERINA VIBROFLEX		60 X 6	-	10.5	45	720
V046	VOMERINA VIBROFLEX		60 X 6	-	10.5	28	720
V048	VOMERINA VIBROFLEX LANCIA		175 X 4	-	10.5	-	400

Tutti gli articoli sono di nostra produzione e non originali. Pesi e misure sono puramente indicativi e possono essere modificati senza preavviso. La riproduzione anche parziale del presente catalogo è vietata. All articles are of our production and not original. Weights and measures are approximate and may change without notice. Reproduction of this catalog is prohibited. Tous les articles sont fabriqués par nous-même mes et non d'origine. Les poids et mesurages sont approximatifs et peuvent changer sans préavis. Alle artikel werden von uns selbst hergestellt und nicht original. Masse und gewichte sind richtwerte und kan ohne vorank undigung gendert werden.

DENTI, VOMERI, SOCS PER TILLER E VIBROCOLTIVATORI

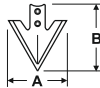

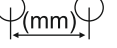
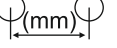
TINES, SHARES, SOCS FOR TILLER OR CHISEL
 DENTS, SOCS POUR TILLER AU CHISEL
 TILLER, SCHARE, GRUBBER - DIENTES, CHISEL PARA TILLER

Codice Ref. Re. Codigo	Marca e descrizione modello Brand name and model description Constructeur et description du modèle Marke und Modell Beschreibung Marca y modelo de descripción	Quote/ Dimensions Abmessungen Dimensiones (mm) 	Piatto Plate Platte Plaque 	Curvatura Curvature Corbure Krummung 	Foro Hole Trou Locher Hoyos Ø (mm) 	Interasse Cent. Distance Achsenabstand Distancia entre ejes 	Peso Weight Gewicht Poids 
------------------------	--	---	--	--	---	---	--

VIBROCOLTIVATORI

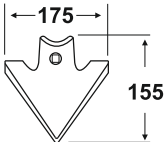
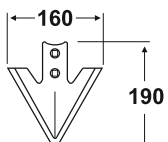
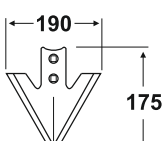
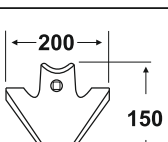
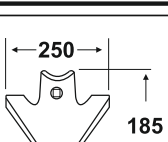
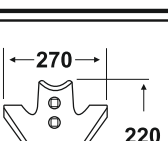
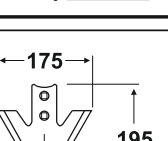
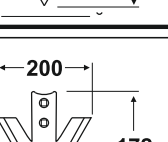



V048P	VOMERINA LANCIA PESANTE		175 X 6	-	10.5	-	460
V053	VOMERINA LANCIA		160 X 4	-	11	40	660
V065	VOMERINA LANCIA		190 X 5	-	11	45	600
V069	VOMERINA LANCIA		200 X 4	-	11	-	500
V070	VOMERINA LANCIA		250 X 4	-	11	-	590
V085	VOMERINA LANCIA		270 X 6	-	13	45	1490
V100	VOMERINA LANCIA		175 X 6	-	10.5	45	440
V114	VOMERINA LANCIA		200 X 4	-	11 X 11	45	590

Tutti gli articoli sono di nostra produzione e non originali. Pesì e misure sono puramente indicativi e possono essere modificati senza preavviso. La riproduzione anche parziale del presente catalogo è vietata. All articles are of our production and not original. Weights and measures are approximate and may change without notice. Reproduction of this catalog is prohibited. Tous les articles sont fabriqués par nous-mêmes et non d'origine. Les poids et mesurés sont approximatifs et peuvent changer sans préavis. Alle artikel werden von uns selbst hergestellt und nicht original. Masse und gewichte sind richtwerte und kan ohne vorank undigung gendert werden.

DENTI, VOMERI, SOCS PER TILLER E VIBROCOLTIVATORI

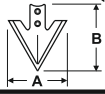

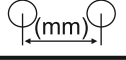
TINES, SHARES, SOCS FOR TILLER OR CHISEL
 DENTS, SOCS POUR TILLER AU CHISEL
 TILLER, SCHARE, GRUBBER - DIENTES, CHISEL PARA TILLER

Codice Ref. Re. Codigo	Marca e descrizione modello Brand name and model description Constructeur et description du modèle Marke und Modell Beschreibung Marca y modelo de descripción	Quote/ Dimensions Abmessungen Dimensiones (mm) 	Piatto Plate Platte Plaque 	Curvatura Curvature Corbure Krümmung 	Foro Hole Trou Locher Hoyos Ø (mm)	Interasse Cent. Distance Achsenabstand Distancia entre ejes 	Peso Weight Gewicht Poids 
---------------------------------	--	---	---	--	---	---	---

AGGIORNAMENTI

				-			
				-			
				-			
				-			
				-			
				-			
				-			
				-			
				-			

Tutti gli articoli sono di nostra produzione e non originali. Pesì e misure sono puramente indicativi e possono essere modificati senza preavviso. La riproduzione anche parziale del presente catalogo è vietata. All articles are of our production and not original. Weights and measures are approximate and may change without notice. Reproduction of this catalog is prohibited. Tous les articles sont fabriqués par nous-même mes et non d'origine. Les poids et mesurés sont approximatifs et peuvent changer sans préavis. Alle artikel werden von uns selbst hergestellt und nicht original. Masse und gewichte sind richtwerte und kan ohne vorank undigung gendert werden.