

COLTELLI PER TRINCIA

BLADES FOR CHOPPERS - COUTEAUX POUR BROYEURS
MESSER - CUCHILLOS PARA TRITURADORAS

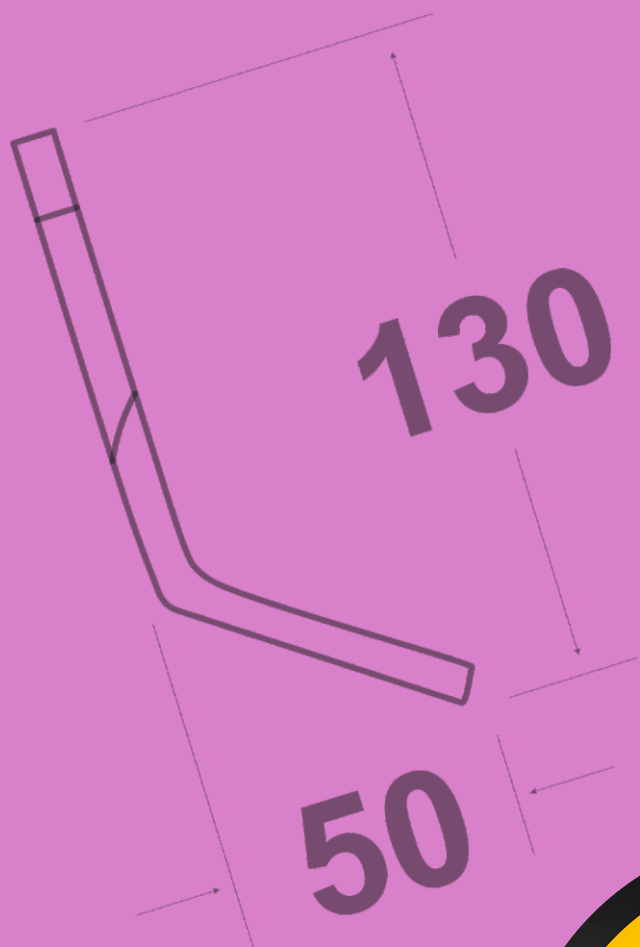





**W
E
E
E
E
E
E
E
E
E**

COLTELLI PER TRINCIA

BLADES FOR CHOPPERS - COUTEAUX POUR BROyeurs
MESSER - CUCHILLOS PARA TRITURADORAS

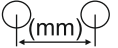

Codice Ref. Re. Codigo	Marca e descrizione modello Brand name and model description Constructeur et description du modèle Marke und Modell Beschreibung Marca y modelo de descripción	Quote/ Dimensions Abmessungen Dimensiones (mm) 	Piatto Plate Platte Plaque 	Curvatura Curvature Corbure Krummung 	Foro Hole Trou Locher Hoyos Ø (mm)	Interasse Cent. Distance Achsenabstand Distancia entre ejes 	Peso Weight Gewicht Poids 
------------------------	--	---	---	--	---	---	---

ACMA

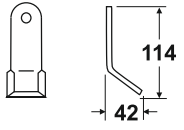
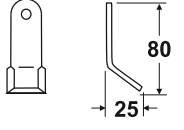
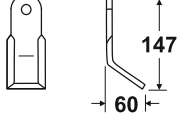
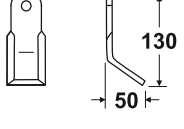
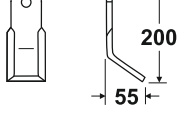
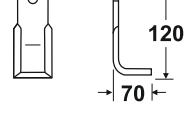
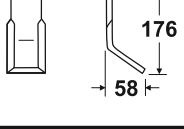



TACM01	COLTELLO Y TL - TLJ LEGGERO Cod Orig: 010 TLC		35 X 5	Y	14.5	-	200
TACM02	COLTELLO Y TM PUMA LEGGERO Cod Orig: 019 THC		35 X 5	Y	14.5	-	120
TACM03	COLTELLO Y TMF - TMS - TML Cod Orig: 012 TMC		60 X 8	Y	25.5	-	120
TACM04	COLTELLO Y TLI SENIOR Cod Orig: 016 TSC		40 X 10	Y	16.5	-	420
TACM05	COLTELLO Y TP TIPO VECCHIO Cod Orig: 018 TPC		60 X 10	Y	25.5	-	930
TACM06	COLTELLO TM 210 - 230 Cod Orig: 013 TMC		60 X 8	SQ	25.5	-	570
TACM07	COLTELLO Y TP Cod Orig: 017 TPC		60 X 10	Y	25.5	-	850
						-	

Tutti gli articoli sono di nostra produzione e non originali. Pesi e misure sono puramente indicativi e possono essere modificati senza preavviso. La riproduzione anche parziale del presente catalogo è vietata. All articles are of our production and not original. Weights and measures are approximate and may change without notice. Reproduction of this catalog is prohibited. Tous les articles sont fabriqués par nous-même et non d'origine. Les poids et mesurés sont approximatifs et peuvent changer sans préavis. Alle artikel werden von uns selbst hergestellt und nicht original. Masse und gewichte sind richtwerte und kan ohne vorank undigung gendert werden.

COLTELLI PER TRINCIA

BLADES FOR CHOPPERS - COUTEAUX POUR BROyeurs
MESSER - CUCHILLOS PARA TRITURADORAS

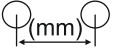

Codice Ref. Re. Codigo	Marca e descrizione modello Brand name and model description Constructeur et description du modèle Marke und Modell Beschreibung Marca y modelo de descripción	Quote/ Dimensions Abmessungen Dimensiones (mm) 	Piatto Plate Platte Plaque 	Curvatura Curvature Corbure Krummung 	Foro Hole Trou Locher Hoyos Ø (mm)	Interasse Cent. Distance Achsenabstand Distancia entre ejes 	Peso Weight Gewicht Poids 
---------------------------------	--	---	---	--	---	---	---

AEDS - PIRCHER

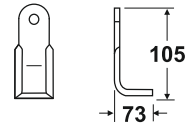
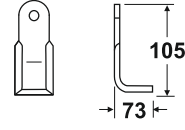
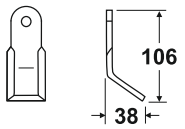
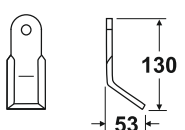
TAED01	COLTELLO		40 X 10	SQ	16.5	-	410
TAED02	COLTELLO		40 X 10	SQ	18.5	-	400
TAED03	COLTELLO Y		40 X 10	Y	16.5	-	330
TAED04	COLTELLO Y		40 X 10	Y	16.5	-	410

AGRAM

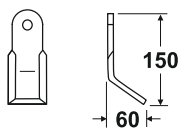
TARM01	COLTELLO Y		65 X 7	Y	29	-	670
--------	------------	---	--------	---	----	---	-----

AGRICOM

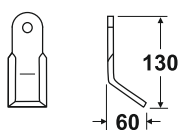



TAGC01	COLTELLO Y TIPO CORTO		60 X 8	Y	16.5	-	480
--------	--------------------------	---	--------	---	------	---	-----

Tutti gli articoli sono di nostra produzione e non originali. Pesi e misure sono puramente indicativi e possono essere modificati senza preavviso. La riproduzione anche parziale del presente catalogo è vietata. All articles are of our production and not original. Weights and measures are approximate and may change without notice. Reproduction of this catalog is prohibited. Tous les articles sont fabriqués par nous-mêmes et non d'origine. Les poids et mesures sont approximatifs et peuvent changer sans préavis. Alle Artikel werden von uns selbst hergestellt und nicht original. Masse und Gewichte sind Richtwerte und können ohne Vorankündigung geändert werden.

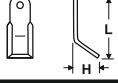

COLTELLI PER TRINCIA

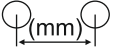
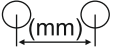
BLADES FOR CHOPPERS - COUTEAUX POUR BROyeurs
MESSER - CUCHILLOS PARA TRITURADORAS

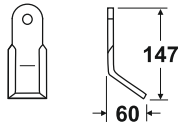
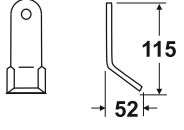
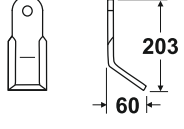
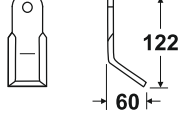
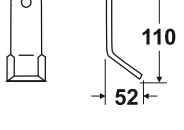
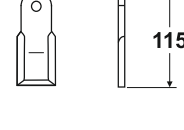
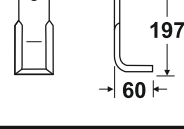

Codice Ref. Re. Codigo	Marca e descrizione modello Brand name and model description Constructeur et description du modèle Marke und Modell Beschreibung Marca y modelo de descripción	Quote/ Dimensions Abmessungen Dimensiones (mm) 	Piatto Plate Platte Plaque 	Curvatura Curvature Corbure Krummung 	Foro Hole Trou Locher Hoyos Ø (mm) 	Interasse Cent. Distance Achsenabstand Distancia entre ejes 	Peso Weight Gewicht Poids 
------------------------	--	---	---	--	--	---	---

AGRICOM





TAGC02	COLTELLO Y TIPO CORTO		60 X 8	Y	25.5	-	520
TAGC03	COLTELLO Y EUROFAST - EUROLIGHT		40 X 8	Y	16.5	-	310
TAGC04	COLTELLO Y EUROSTOCK		60 X 8	Y	16.5	-	720
TAGC05	COLTELLO Y TIPO NUOVO		50 X 10	Y	16.5	-	490
TAGC06	COLTELLO Y		40 X 10	Y	16.5	-	350
TAGC07	COLTELLO DIRITTO		40 X 8	D	16.5	-	300
TAGC08	COLTELLO		60 X 8	SQ	25.5	-	800
TAGC09	COLTELLO RUOTA INTERFILA ROTAZIONE SX		60 X 8	D	25.5	-	800

Tutti gli articoli sono di nostra produzione e non originali. Pesì e misure sono puramente indicativi e possono essere modificati senza preavviso. La riproduzione anche parziale del presente catalogo è vietata. All articles are of our production and not original. Weights and measures are approximate and may change without notice. Reproduction of this catalog is prohibited. Tous les articles sont fabriqués par nous-mêmes et non d'origine. Les poids et mesures sont approximatifs et peuvent changer sans préavis. Alle artikel werden von uns selbst hergestellt und nicht original. Masse und gewichte sind richtwerte und kan ohne vorank undigung gendert werden.

COLTELLI PER TRINCIA

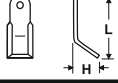
BLADES FOR CHOPPERS - COUTEAUX POUR BROyeurs
MESSER - CUCHILLOS PARA TRITURADORAS

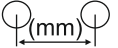
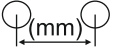

Codice Ref. Re. Codigo	Marca e descrizione modello Brand name and model description Constructeur et description du modèle Marke und Modell Beschreibung Marca y modelo de descripción	Quote/ Dimensions Abmessungen Dimensiones (mm) 	Piatto Plate Platte Plaque 	Curvatura Curvature Corbure Krummung 	Foro Hole Trou Locher Hoyos Ø (mm) 	Interasse Cent. Distance Achsenabstand Distancia entre ejes 	Peso Weight Gewicht Poids 
------------------------	--	---	---	--	--	---	---

AGRICOM

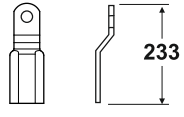
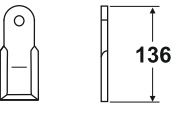
TAGC10	COLTELLO RUOTA INTERFILEA SENZA ALETTA		60 X 8	D	25.5	-	860
TAGC11	COLTELLO DIRITTO		60 X 8	D	16.5	-	475

AGRIMASTER

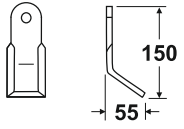
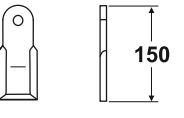
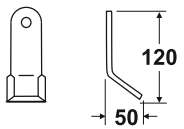
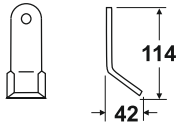
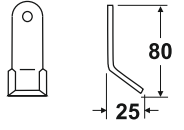
TAGM01	COLTELLO Y K8 - RMU - RMUGL Cod. Orig: 3000106		60 X 10	Y	25.5	-	650
TAGM02	COLTELLO DIRITTO K8 - RMU - RMUGL Cod Orig: 3000107		60 X 10	D	25.5	-	610
TAGM03	COLTELLO Y C - ELP - SICURA KP - KL - SHARK Cod Orig: 3000323		40 X 8	Y	20.5	-	300
TAGM04	COLTELLO Y ELL - LM TIPO VECCHIO Cod Orig: 3000650		35 X 5	Y	14.5	-	200
TAGM05	COLTELLO Y YO YO LME GREEN SHARK Cod Orig: 3000993		35 X 5	Y	14.5	-	105

Tutti gli articoli sono di nostra produzione e non originali. Pesì e misure sono puramente indicativi e possono essere modificati senza preavviso. La riproduzione anche parziale del presente catalogo è vietata. All articles are of our production and not original. Weights and measures are approximate and may change without notice. Reproduction of this catalog is prohibited. Tous les articles sont fabriqués par nous-mêmes et non d'origine. Les poids et mesures sont approximatifs et peuvent changer sans préavis. Alle artikel werden von uns selbst hergestellt und nicht original. Masse und gewichte sind richtwerte und kan ohne vorank undigung gendert werden.

COLTELLI PER TRINCIA

BLADES FOR CHOPPERS - COUTEAUX POUR BROyeurs
MESSER - CUCHILLOS PARA TRITURADORAS



Codice Ref. Re. Codigo	Marca e descrizione modello Brand name and model description Constructeur et description du modèle Marke und Modell Beschreibung Marca y modelo de descripción	Quote/ Dimensions Abmessungen Dimensiones (mm) 	Piatto Plate Platte Plaque 	Curvatura Curvature Corbure Krummung 	Foro Hole Trou Locher Hoyos Ø (mm)	Interasse Cent. Distance Achsenabstand Distancia entre ejes 	Peso Weight Gewicht Poids
------------------------	--	--	---	---	---	--	--

AGRIMASTER





TAGM06	COLTELLO BIETOLE - RMU - K8 Cod Orig: 3001221		60 X 10	SQ	25.5	-	730
TAGM07	COLTELLO Y ASOLA XB - GREEN SHARK Cod Orig: 3005674		40 X 5	Y	30 X 14	-	140
TAGM08	COLTELLO DIRITTO ASOLA XB - GREEN SHARK Cod Orig: 3005675		40 X 5	D	30 X 14	-	120
TAGM09	COLTELLO Y EXPERT Cod Orig: 3006280		40 X 10	Y	14.5	-	380
TAGM10	COLTELLO DIRITTO SICURA Cod Orig: 3007853		40 X 8	D	20.5	-	290
TAGM11	COLTELLO RUOTA INTERFILE 2 TAGLIENTI		60 X 8	D	25.5	-	800
TAGM12	COLTELLO RUOTA INTERFILE ROTAZIONE SX		60 X 8	D	25.5	-	800
TAGM13	COLTELLO DIRITTO EXPERT Cod Orig: 3008349		40 X 10	D	14.5	-	300

Tutti gli articoli sono di nostra produzione e non originali. Pesi e misure sono puramente indicativi e possono essere modificati senza preavviso. La riproduzione anche parziale del presente catalogo è vietata. All articles are of our production and not original. Weights and measures are approximate and may change without notice. Reproduction of this catalog is prohibited. Tous les articles sont fabriqués par nous-même et non d'origine. Les poids et mesurés sont approximatifs et peuvent changer sans préavis. Alle artikel werden von uns selbst hergestellt und nicht original. Masse und gewichte sind richtwerte und kan ohne vorank undigung gendert werden.

COLTELLI PER TRINCIA

BLADES FOR CHOPPERS - COUTEAUX POUR BROyeurs
MESSER - CUCHILLOS PARA TRITURADORAS

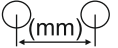

Codice Ref. Re. Codigo	Marca e descrizione modello Brand name and model description Constructeur et description du modèle Marke und Modell Beschreibung Marca y modelo de descripción	Quote/ Dimensions Abmessungen Dimensiones (mm) 	Piatto Plate Platte Plaque 	Curvatura Curvature Corbure Krummung 	Foro Hole Trou Locher Hoyos Ø (mm)	Interasse Cent. Distance Achsenabstand Distancia entre ejes 	Peso Weight Gewicht Poids 
------------------------	--	---	---	--	---	---	---

AGRIMASTER

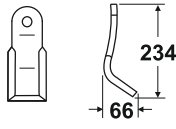
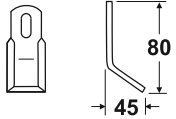
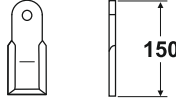
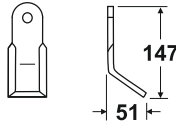
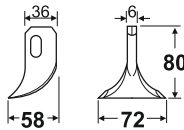
TAGM14	COLTELLO Y IRON Cod Orig: 3004742		60 X 8	Y	25.5	-	950
TAGM15	COLTELLO Y ASOLA A - GREEN SHARK Cod Orig: 3005566		40 X 8	Y	30 X 14	-	200
TAGM16	COLTELLO DIRITTO RMU TIPO NUOVO		60 X 8	D	25.5	-	450
TAGM17	COLTELLO Y		60 X 8	Y	25.5	-	520
TAGM18	SPATOLA ASOLA TKA - TKB		70 X 3	-	19 X 13	-	160

AGROTEC

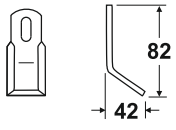
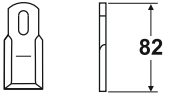





TAGT01	COLTELLO Y ASOLA		40 X 5	Y	30 X 14	-	140
TAGT02	COLTELLO DIRITTO ASOLA		40 X 5	D	30 X 14	-	120

Tutti gli articoli sono di nostra produzione e non originali. Pesi e misure sono puramente indicativi e possono essere modificati senza preavviso. La riproduzione anche parziale del presente catalogo è vietata. All articles are of our production and not original. Weights and measures are approximate and may change without notice. Reproduction of this catalog is prohibited. Tous les articles sont fabriqués par nous-mêmes et non d'origine. Les poids et mesures sont approximatifs et peuvent changer sans préavis. Alle Artikel werden von uns selbst hergestellt und nicht original. Masse und Gewichte sind Richtwerte und können ohne Vorankündigung geändert werden.

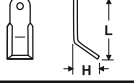
COLTELLI PER TRINCIA

BLADES FOR CHOPPERS - COUTEAUX POUR BROYEURS
MESSER - CUCHILLOS PARA TRITURADORAS



Codice Ref. Re. Codigo	Marca e descrizione modello Brand name and model description Constructeur et description du modèle Marke und Modell Beschreibung Marca y modelo de descripción	Quote/ Dimensions Abmessungen Dimensiones (mm) 	Piatto Plate Platte Plaque 	Curvatura Curvature Corbure Krummung 	Foro Hole Trou Locher Hoyos Ø (mm) 	Interasse Cent. Distance Achsenabstand Distancia entre ejes 	Peso Weight Gewicht Poids 
------------------------	--	---	---	--	--	---	---

ARTEMECCANICA

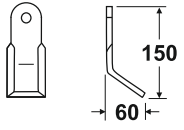
TATM01	COLTELLO Y		60 X 8	Y	25.5	-	600
--------	------------	---	--------	---	------	---	-----

ASSALONI

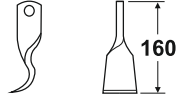
TASS01	DENTE GIRATO		40 X 10	-	20.5	-	450
--------	--------------	---	---------	---	------	---	-----

BCS

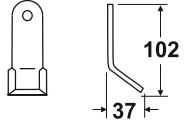
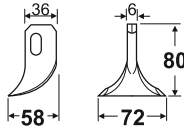
TBCS01	COLTELLO Y Cod Orig: 93581		30 X 4	Y	12.5	-	150
TBCS02	SPATOLA ASOLA		70 X 3	-	19 X 13	-	160

BECCHIO BERFRALK

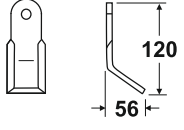
TBER01	COLTELLO Y Cod Orig: A0005		40 X 12	Y	19.5	-	740
--------	-------------------------------	---	---------	---	------	---	-----

Tutti gli articoli sono di nostra produzione e non originali. Pesi e misure sono puramente indicativi e possono essere modificati senza preavviso. La riproduzione anche parziale del presente catalogo è vietata. All articles are of our production and not original. Weights and measures are approximate and may change without notice. Reproduction of this catalog is prohibited. Tous les articles sont fabriqués par nous-mêmes et non d'origine. Les poids et mesurent approximatifs et peuvent changer sans préavis. Alle artikel werden von uns selbst hergestellt und nicht original. Masse und gewichte sind richtwerte und kan ohne vorank undigung gendert werden.

COLTELLI PER TRINCIA

BLADES FOR CHOPPERS - COUTEAUX POUR BROyeurs
MESSER - CUCHILLOS PARA TRITURADORAS



Codice Ref. Re. Codigo	Marca e descrizione modello Brand name and model description Constructeur et description du modèle Marke und Modell Beschreibung Marca y modelo de descripción	Quote/ Dimensions Abmessungen Dimensiones (mm) 	Piatto Plate Platte Plaque 	Curvatura Curvature Corbure Krummung 	Foro Hole Trou Locher Hoyos Ø (mm) 	Interasse Cent. Distance Achsenabstand Distancia entre ejes 	Peso Weight Gewicht Poids
------------------------	--	--	---	---	---	--	--

BECCHIO BERFRALK







TBER02	COLTELLO DIRITTO Cod Orig: A0002		40 X 12	D	19.5	-	700
TBER03	COLTELLO Y TIPO VECCHIO		40 X 12	Y	16.5	-	460
TBER04	COLTELLO DIRITTO TIPO VECCHIO		40 X 12	D	16.5	-	470
TBER05	COLTELLO Y		60 X 8	Y	25.5	-	740
TBER06	COLTELLO DIRITTO		60 X 8	D	25.5	-	700
TBER07	COLTELLO Y PESANTE		60 X 10	Y	25.5	-	930
TBER08	COLTELLO Y ASOLA TIPO VECCHIO		40 X 8	Y	25 X 14	-	250
TBER09	COLTELLO Y BM Cod Orig: A0776		50 X 12	Y	19.5	-	550

Tutti gli articoli sono di nostra produzione e non originali. Pesi e misure sono puramente indicativi e possono essere modificati senza preavviso. La riproduzione anche parziale del presente catalogo è vietata. All articles are of our production and not original. Weights and measures are approximate and may change without notice. Reproduction of this catalog is prohibited. Tous les articles sont fabriqués par nous-même et non d'origine. Les poids et mesurssont approximatifs et peuvent changer sans preavis. Alle artikel werden von uns selbst hergestellt und nicht original. Masse und gewichte sind richtwerte und kan ohne vorank undigung gendert werden.

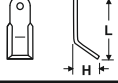
COLTELLI PER TRINCIA

BLADES FOR CHOPPERS - COUTEAUX POUR BROyeurs
MESSER - CUCHILLOS PARA TRITURADORAS



Codice Ref. Re. Codigo	Marca e descrizione modello Brand name and model description Constructeur et description du modèle Marke und Modell Beschreibung Marca y modelo de descripción	Quote/ Dimensions Abmessungen Dimensiones (mm) 	Piatto Plate Platte Plaque 	Curvatura Curvature Corbure Krummung 	Foro Hole Trou Locher Hoyos Ø (mm) 	Interasse Cent. Distance Achsenabstand Distancia entre ejes 	Peso Weight Gewicht Poids 
------------------------	--	---	---	--	--	---	---

BELLON MIT

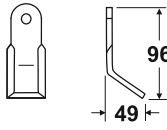
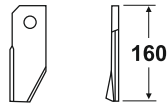
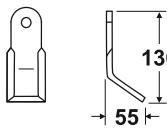
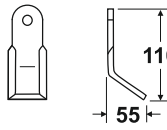
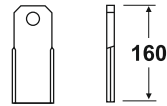
TBELO1	COLTELLO Y		35 X 6	Y	20.5	-	160
TBELO2	COLTELLO SX MRM - MRB - MDS Cod Orig: 7CLABS0004		60 X 6	D	22.5	-	430
TBELO3	COLTELLO Y		60 X 10	Y	26.5	-	440
TBELO4	COLTELLO Y		50 X 6	Y	25.5	-	300
TBELO5	COLTELLO DIRITTO MRM - MRB - MDS Cod Orig: 7CLAB00005		60 X 6	D	22.5	-	450
						-	

BENASSI

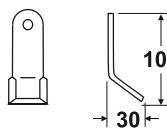
TBEN01	COLTELLO Y TR 60 Cod Orig: 6CM147		30 X 4	Y	10.5	-	90
--------	---	---	--------	---	------	---	----

Tutti gli articoli sono di nostra produzione e non originali. Pesi e misure sono puramente indicativi e possono essere modificati senza preavviso. La riproduzione anche parziale del presente catalogo è vietata. All articles are of our production and not original. Weights and measures are approximate and may change without notice. Reproduction of this catalog is prohibited. Tous les articles sont fabriqués par nous-mêmes et non d'origine. Les poids et mesures sont approximatifs et peuvent changer sans préavis. Alle artikel werden von uns selbst hergestellt und nicht original. Masse und gewichte sind richtwerte und kan ohne vorank undigung gendert werden.

COLTELLI PER TRINCIA

BLADES FOR CHOPPERS - COUTEAUX POUR BROyeurs
MESSER - CUCHILLOS PARA TRITURADORAS



Codice Ref. Re. Codigo	Marca e descrizione modello Brand name and model description Constructeur et description du modèle Marke und Modell Beschreibung Marca y modelo de descripción	Quote/ Dimensions Abmessungen Dimensiones (mm) 	Piatto Plate Platte Plaque 	Curvatura Curvature Corbure Krummung 	Foro Hole Trou Locher Hoyos Ø (mm)	Interasse Cent. Distance Achsenabstand Distancia entre ejes 	Peso Weight Gewicht Poids
------------------------	--	--	---	---	---	--	--

BERTI





TBRT01	COLTELLO Y TSB		60 X 8	Y	28.5	-	660
TBRT02	COLTELLO DIRITTO TSB		60 X 8	D	28.5	-	640
TBRT03	COLTELLO Y		60 X 10	Y	28.5	-	950
TBRT04	COLTELLO Y TIPO LUNGO		60 X 8	Y	28.5	-	730
TBRT05	COLTELLO Y EKR Cod Orig: C5008-1838		50 X 8	Y	25.5	-	400
TBRT06	COLTELLO Y ASOLA		40 X 8	Y	35 X 17	-	200
TBRT07	COLTELLO DIRITTO EKR Cod Orig: Cd2421		50 X 8	D	25.5	-	250
TBRT08	COLTELLO TSB		60 X 8	SQ	29.5	-	750

Tutti gli articoli sono di nostra produzione e non originali. Pesi e misure sono puramente indicativi e possono essere modificati senza preavviso. La riproduzione anche parziale del presente catalogo è vietata. All articles are of our production and not original. Weights and measures are approximate and may change without notice. Reproduction of this catalog is prohibited. Tous les articles sont fabriqués par nous-mêmes et non d'origine. Les poids et mesures sont approximatifs et peuvent changer sans préavis. Alle artikel werden von uns selbst hergestellt und nicht original. Masse und gewichte sind richtwerte und kan ohne vorank undigung gendert werden.

COLTELLI PER TRINCIA

BLADES FOR CHOPPERS - COUTEAUX POUR BROyeurs
MESSER - CUCHILLOS PARA TRITURADORAS

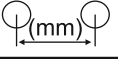

Codice Ref. Re. Codigo	Marca e descrizione modello Brand name and model description Constructeur et description du modèle Marke und Modell Beschreibung Marca y modelo de descripción	Quote/ Dimensions Abmessungen Dimensiones (mm) 	Piatto Plate Platte Plaque 	Curvatura Curvature Corbure Krummung 	Foro Hole Trou Locher Hoyos Ø (mm)	Interasse Cent. Distance Achsenabstand Distancia entre ejes 	Peso Weight Gewicht Poids 
------------------------	--	---	---	--	---	---	---

BERTI

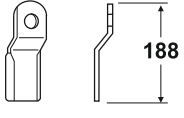
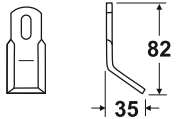
TBRT09	COLTELLO RUOTA INTERFILEA		80 X 7	D	26	-	800
TBRT10	COLTELLO Y ASOLA		40 X 5	Y	27 X 13	-	120

BERTOLINI - YABE

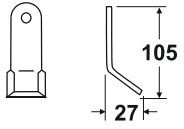
TBRL01	COLTELLO Y Cod Orig: 1520107		30 X 4	Y	10.5	-	120
--------	---------------------------------	---	--------	---	------	---	-----

BOMFORD TURNER

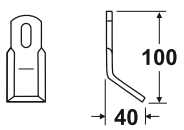
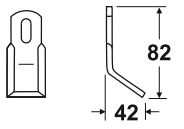
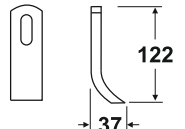





TBMF01	COLTELLO Y ASOLA Cod Orig: 7190177		35 X 8	Y	33 X 14	-	190
TBMF02	COLTELLO Y ASOLA		40 X 5	Y	30 X 14	-	140
TBMF03	COLTELLO SPATOLA ASOLA		40 X 10	C	39 X 14	-	340

Tutti gli articoli sono di nostra produzione e non originali. Pesì e misure sono puramente indicativi e possono essere modificati senza preavviso. La riproduzione anche parziale del presente catalogo è vietata. All articles are of our production and not original. Weights and measures are approximate and may change without notice. Reproduction of this catalog is prohibited. Tous les articles sont fabriqués par nous-mêmes et non d'origine. Les poids et mesures sont approximatifs et peuvent changer sans préavis. Alle artikel werden von uns selbst hergestellt und nicht original. Masse und gewichte sind richtwerte und kan ohne vorank undigung gendert werden.

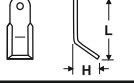
COLTELLI PER TRINCIA

BLADES FOR CHOPPERS - COUTEAUX POUR BROyeurs
MESSER - CUCHILLOS PARA TRITURADORAS



Codice Ref. Re. Codigo	Marca e descrizione modello Brand name and model description Constructeur et description du modèle Marke und Modell Beschreibung Marca y modelo de descripción	Quote/ Dimensions Abmessungen Dimensiones (mm) 	Piatto Plate Platte Plaque 	Curvatura Curvature Corbure Krummung 	Foro Hole Trou Locher Hoyos Ø (mm) 	Interasse Cent. Distance Achsenabstand Distancia entre ejes 	Peso Weight Gewicht Poids 
------------------------	--	---	--	--	---	---	--

BOMFORD TURNER

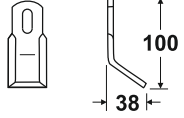
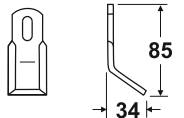
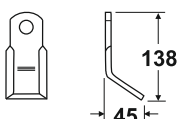
TBMF04	COLTELLO Y ASOLA		40 X 5	Y	27 X 14	-	150
TBMF05	COLTELLO Y ASOLA		40 X 6	Y	32 X 16	-	160
TBMF06	COLTELLO		50 X 6	Y	27	-	320

BRABER

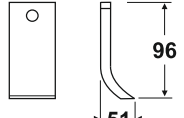
TBRB01	COLTELLO SPATOLA		65 X 6	C	14.5	-	360
--------	------------------	---	--------	---	------	---	-----

BREVIGLIERI

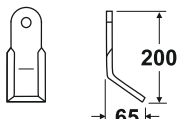
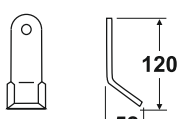
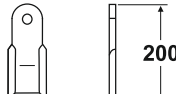



TBRE01	COLTELLO Y		60 X 10	Y	25.5	-	1000
TBRE02	COLTELLO Y LEGGERO PER SARMENTI Cod Orig: 2079		40 X 10	Y	16.5	-	360
TBRE03	COLTELLO DIRITTO		60 X 10	D	25.5	-	840

Tutti gli articoli sono di nostra produzione e non originali. Pesi e misure sono puramente indicativi e possono essere modificati senza preavviso. La riproduzione anche parziale del presente catalogo è vietata. All articles are of our production and not original. Weights and measures are approximate and may change without notice. Reproduction of this catalog is prohibited. Tous les articles sont fabriqués par nous-même mes et non d'origine. Les poids et mesurés sont approximatifs et peuvent changer sans préavis. Alle artikel werden von uns selbst hergestellt und nicht original. Masse und gewichte sind richtwerte und kan ohne vorank undigung gendert werden.

COLTELLI PER TRINCIA

BLADES FOR CHOPPERS - COUTEAUX POUR BROyeurs
MESSER - CUCHILLOS PARA TRITURADORAS

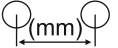
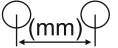

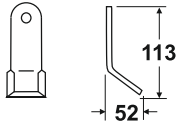
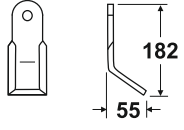
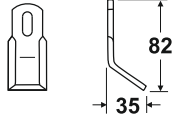
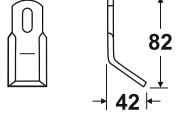

Codice Ref. Re. Codigo	Marca e descrizione modello Brand name and model description Constructeur et description du modèle Marke und Modell Beschreibung Marca y modelo de descripción	Quote/ Dimensions Abmessungen Dimensiones (mm) 	Piatto Plate Platte Plaque 	Curvatura Curvature Corbure Krummung 	Foro Hole Trou Locher Hoyos Ø (mm) 	Interasse Cent. Distance Achsenabstand Distancia entre ejes 	Peso Weight Gewicht Poids 
------------------------	--	---	---	--	--	---	---

BREVIGLIERI

TBRE04	COLTELLO Y T 70 Cod Orig: 0058115		40 X 10	Y	16.5	-	340
TBRE05	COLTELLO Y H 80 Cod Orig: T0100031		60 X 10	Y	25.5	-	860
TBRE06	COLTELLO Y ASOLA TR Cod Orig: 051118		40 X 5	Y	27 X 13	-	120
TBRE07	COLTELLO Y ASOLA		40 X 5	Y	30 X 14	-	140

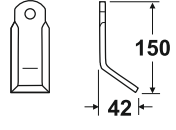
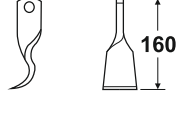
BRUNI







TBRN01	COLTELLO SPATOLA		45 X 5	Y	20.5	-	240
TBRN02	DENTE GIRATO		40 X 10	D	20.5	-	450
TBRN03	DENTE GIRATO TIPO NUOVO		50 X 10	D	20.5	-	450

Tutti gli articoli sono di nostra produzione e non originali. Pesi e misure sono puramente indicativi e possono essere modificati senza preavviso. La riproduzione anche parziale del presente catalogo è vietata. All articles are of our production and not original. Weights and measures are approximate and may change without notice. Reproduction of this catalog is prohibited. Tous les articles sont fabriqués par nous-mêmes et non d'origine. Les poids et mesures sont approximatifs et peuvent changer sans préavis. Alle artikel werden von uns selbst hergestellt und nicht original. Masse und gewichte sind richtwerte und kan ohne vorank undigung gendert werden.

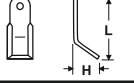
COLTELLI PER TRINCIA

BLADES FOR CHOPPERS - COUTEAUX POUR BROyeurs
MESSER - CUCHILLOS PARA TRITURADORAS



Codice Ref. Re. Codigo	Marca e descrizione modello Brand name and model description Constructeur et description du modèle Marke und Modell Beschreibung Marca y modelo de descripción	Quote/ Dimensions Abmessungen Dimensiones (mm) 	Piatto Plate Platte Plaque 	Curvatura Curvature Corbure Krummung 	Foro Hole Trou Locher Hoyos Ø (mm) 	Interasse Cent. Distance Achsenabstand Distancia entre ejes 	Peso Weight Gewicht Poids 
---------------------------------	--	---	---	--	--	---	---

CABE - NUOVA CABE

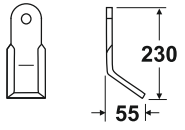
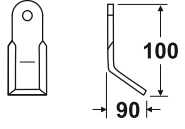
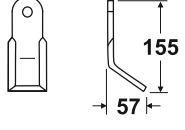
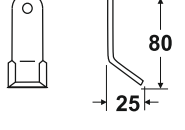
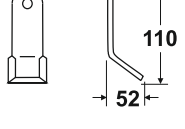
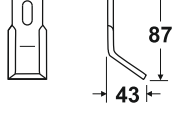
TCBE01	COLTELLO Y UNIVERSALE Cod Orig: 000185		60 X 7	Y	28.5	-	700
TCBE02	COLTELLO Y TFU		50 X 8	Y	20.5	-	500
TCBE03	COLTELLO Y TIPO CORTO		60 X 7	Y	28.5	-	450
TCBE04	COLTELLO Y LEGGERO		35 X 5	Y	14.5	-	120
TCBE05	COLTELLO Y TEN		40 X 8	Y	20.5	-	280
TCBE06	COLTELLO Y ASOLA		40 X 6	Y	30 X 14	-	170

CALDERONI

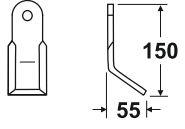



TCAL01	COLTELLO Y		60 X 10	Y	25.5	-	650
--------	-------------------	---	---------	---	------	---	-----

Tutti gli articoli sono di nostra produzione e non originali. Pesì e misure sono puramente indicativi e possono essere modificati senza preavviso. La riproduzione anche parziale del presente catalogo è vietata. All articles are of our production and not original. Weights and measures are approximate and may change without notice. Reproduction of this catalog is prohibited. Tous les articles sont fabriqués par nous-mêmes et non d'origine. Les poids et mesurent approximatifs et peuvent changer sans préavis. Alle artikel werden von uns selbst hergestellt und nicht original. Masse und gewichte sind richtwerte und kan ohne vorank undigung gendert werden.

COLTELLI PER TRINCIA

BLADES FOR CHOPPERS - COUTEAUX POUR BROyeurs
MESSER - CUCHILLOS PARA TRITURADORAS

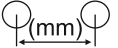
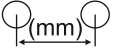

Codice Ref. Re. Codigo	Marca e descrizione modello Brand name and model description Constructeur et description du modèle Marke und Modell Beschreibung Marca y modelo de descripción	Quote/ Dimensions Abmessungen Dimensiones (mm) 	Piatto Plate Platte Plaque 	Curvatura Curvature Corbure Krummung 	Foro Hole Trou Locher Hoyos Ø (mm) 	Interasse Cent. Distance Achsenabstand Distancia entre ejes 	Peso Weight Gewicht Poids 
------------------------	--	---	---	--	--	---	---

CALDERONI

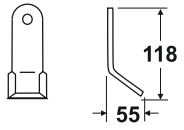
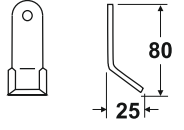
TCAL02	COLTELLO Y LEGGERO		40 X 8	Y	25.5	-	300
TCAL03	COLTELLO Y LM 3 TIPO NUOVO		35 X 5	Y	14.5	-	120

CARONI

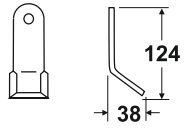
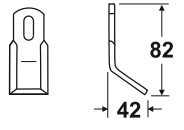
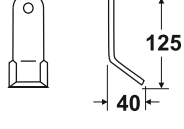
TCRN01	COLTELLO Y Cod Orig: 5001250		40 X 5	Y	12.5	-	200
TCRN02	COLTELLO Y ASOLA Cod Orig: 10007440		40 X 5	Y	30 X 14	-	140
TCRN03	COLTELLO Y Cod Orig: 5001200		40 X 5	Y	10.5	-	200

CARROY GIRAUDON

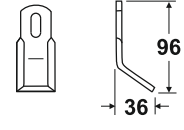
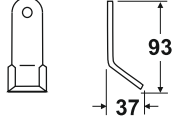





TCRG01	COLTELLO Y ASOLA Cod Orig: 16039		40 X 6	Y	34 X 15	-	160
TCRG02	COLTELLO Y Cod Orig: 26264		40 X 6	Y	13	-	190

Tutti gli articoli sono di nostra produzione e non originali. Pesi e misure sono puramente indicativi e possono essere modificati senza preavviso. La riproduzione anche parziale del presente catalogo è vietata. All articles are of our production and not original. Weights and measures are approximate and may change without notice. Reproduction of this catalog is prohibited. Tous les articles sont fabriqués par nous-même et non d'origine. Les poids et mesurés sont approximatifs et peuvent changer sans préavis. Alle artikel werden von uns selbst hergestellt und nicht original. Masse und gewichte sind richtwerte und kan ohne vorank undigung gendert werden.

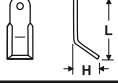
COLTELLI PER TRINCIA

BLADES FOR CHOPPERS - COUTEAUX POUR BROyeurs
MESSER - CUCHILLOS PARA TRITURADORAS



Codice Ref. Re. Codigo	Marca e descrizione modello Brand name and model description Constructeur et description du modèle Marke und Modell Beschreibung Marca y modelo de descripción	Quote/ Dimensions Abmessungen Dimensiones (mm) 	Piatto Plate Platte Plaque 	Curvatura Curvature Corbure Krummung 	Foro Hole Trou Locher Hoyos Ø (mm) 	Interasse Cent. Distance Achsenabstand Distancia entre ejes 	Peso Weight Gewicht Poids 
------------------------	--	---	---	--	--	---	---

CELLI

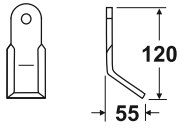
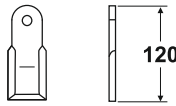
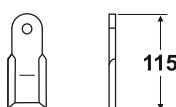
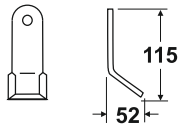
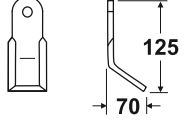
TCEL01	COLTELLO Y Cod Orig: 702611		50 X 10	Y	16.5	-	470
TCEL02	COLTELLO DIRITTO Cod Orig: 702612		50 X 10	D	16.5	-	430
TCEL03	COLTELLO DIRITTO LEGGERO		40 X 8	D	16.5	-	320
TCEL04	COLTELLO Y LEGGERO		40 X 8	Y	16.5	-	310
TCEL05	COLTELLO Y		60 X 8	Y	25.5	-	740
TCEL06	COLTELLO Y VEGA Cod Orig: 704050		40 X 10	Y	16.5	-	425

COSMA

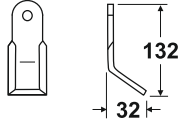
TCSM01	COLTELLO Y DS 2		50 X 6	Y	20.5	-	370
--------	----------------------------	---	--------	---	------	---	-----

Tutti gli articoli sono di nostra produzione e non originali. Pesi e misure sono puramente indicativi e possono essere modificati senza preavviso. La riproduzione anche parziale del presente catalogo è vietata. All articles are of our production and not original. Weights and measures are approximate and may change without notice. Reproduction of this catalog is prohibited. Tous les articles sont fabriqués par nous-mêmes et non d'origine. Les poids et mesures sont approximatifs et peuvent changer sans préavis. Alle Artikel werden von uns selbst hergestellt und nicht original. Masse und Gewichte sind Richtwerte und können ohne Vorankündigung geändert werden.

COLTELLI PER TRINCIA

BLADES FOR CHOPPERS - COUTEAUX POUR BROyeurs
MESSER - CUCHILLOS PARA TRITURADORAS



Codice Ref. Re. Codigo	Marca e descrizione modello Brand name and model description Constructeur et description du modèle Marke und Modell Beschreibung Marca y modelo de descripción	Quote/ Dimensions Abmessungen Dimensiones (mm) 	Piatto Plate Platte Plaque 	Curvatura Curvature Corbure Krummung 	Foro Hole Trou Locher Hoyos Ø (mm)	Interasse Cent. Distance Achsenabstand Distancia entre ejes 	Peso Weight Gewicht Poids
------------------------	--	--	---	---	---	--	--

COSMA

TCSM02	COLTELLO Y DS 2 RINFORZATO		50 X 8	Y	20.5	-	490
TCSM03	COLTELLO Y		50 X 8	Y	20.5	-	550
TCSM04	DENTE GIRATO		40 X 10	D	20.5	-	450
TCSM05	COLTELLO Y ASOLA		40 X 8	Y	30 X 14	-	250

DEL MORINO





TDLM01	COLTELLO Y FLIPPER Cod Orig: 132158186		40 X 8	Y	20.5	-	300
TDLM02	COLTELLO Y FLIPPER Cod Orig: 80106		35 X 5	Y	14.5	-	200
TDLM03	SPATOLA ASOLA FLIPPER - FUNNY		70 X 3	-	19 X 13	-	160

Tutti gli articoli sono di nostra produzione e non originali. Pesi e misure sono puramente indicativi e possono essere modificati senza preavviso. La riproduzione anche parziale del presente catalogo è vietata. All articles are of our production and not original. Weights and measures are approximate and may change without notice. Reproduction of this catalog is prohibited. Tous les articles sont fabriqués par nous-mêmes et non d'origine. Les poids et mesures sont approximatifs et peuvent changer sans préavis. Alle artikel werden von uns selbst hergestellt und nicht original. Masse und gewichte sind richtwerte und kan ohne vorank undigung gendert werden.

COLTELLI PER TRINCIA

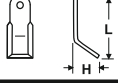
BLADES FOR CHOPPERS - COUTEAUX POUR BROyeurs
MESSER - CUCHILLOS PARA TRITURADORAS

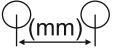
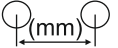

Codice Ref. Re. Codigo	Marca e descrizione modello Brand name and model description Constructeur et description du modèle Marke und Modell Beschreibung Marca y modelo de descripción	Quote/ Dimensions Abmessungen Dimensiones (mm) 	Piatto Plate Platte Plaque 	Curvatura Curvature Corbure Krummung 	Foro Hole Trou Locher Hoyos Ø (mm) 	Interasse Cent. Distance Achsenabstand Distancia entre ejes 	Peso Weight Gewicht Poids 
------------------------	--	---	---	--	--	---	---

DESVOYS

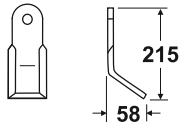
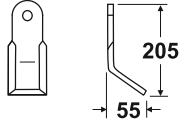
TDSV01	COLTELLO Y Cod Orig: 433		60 X 8	Y	25.5	-	830
TDSV02	COLTELLO Y		60 X 8	Y	25.5	-	800

DRAGONE

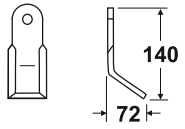
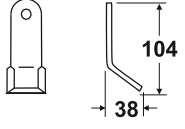
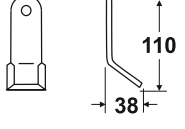
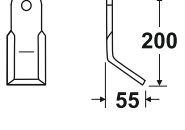
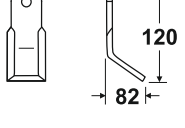



TDRA01	COLTELLO Y		50 X 8	Y	18.5	-	430
TDRA02	COLTELLO Y		40 X 10	Y	16.5	-	300
TDRA03	COLTELLO Y		40 X 10	Y	18.5	-	330
TDRA04	COLTELLO Y		60 X 10	Y	25.5	-	930
TDRA05	COLTELLO Y Cod Orig: 10102653		50 x 8	Y	18.5	-	400

Tutti gli articoli sono di nostra produzione e non originali. Pesì e misure sono puramente indicativi e possono essere modificati senza preavviso. La riproduzione anche parziale del presente catalogo è vietata. All articles are of our production and not original. Weights and measures are approximate and may change without notice. Reproduction of this catalog is prohibited. Tous les articles sont fabriqués par nous-mêmes et non d'origine. Les poids et mesures sont approximatifs et peuvent changer sans préavis. Alle Artikel werden von uns selbst hergestellt und nicht original. Masse und Gewichte sind Richtwerte und können ohne Vorankündigung geändert werden.

COLTELLI PER TRINCIA

BLADES FOR CHOPPERS - COUTEAUX POUR BROyeurs
MESSER - CUCHILLOS PARA TRITURADORAS

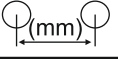
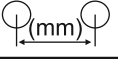

Codice Ref. Re. Codigo	Marca e descrizione modello Brand name and model description Constructeur et description du modèle Marke und Modell Beschreibung Marca y modelo de descripción	Quote/ Dimensions Abmessungen Dimensiones (mm) 	Piatto Plate Platte Plaque 	Curvatura Curvature Corbure Krummung 	Foro Hole Trou Locher Hoyos Ø (mm) 	Interasse Cent. Distance Achsenabstand Distancia entre ejes 	Peso Weight Gewicht Poids 
------------------------	--	---	---	--	--	---	---

DRAGONE

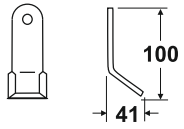
TDRA06	COLTELLO Y Cod Orig: 19202653		40 X 5	Y	16.5	-	160
--------	----------------------------------	---	--------	---	------	---	-----

DUCKER

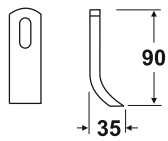
TDUC01	COLTELLO SPATOLA ASOLA		50 X 10	C	33 X 20	-	285
--------	---------------------------	--	---------	---	---------	---	-----

ENERGREEN

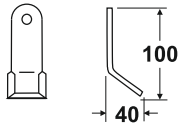
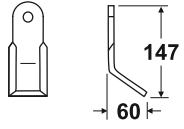
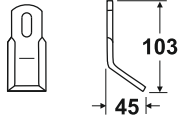
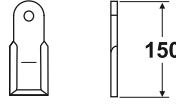
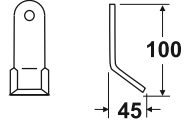



TENR01	COLTELLO Y		35 X 6	Y	12.5	-	160
TENR02	COLTELLO Y		60 X 8	Y	25.5	-	520
TENR03	COLTELLO Y ASOLA		40 X 8	Y	35 X 17	-	250
TENR04	COLTELLO DIRITTO		60 X 8	D	25.5	-	450
TENR05	COLTELLO Y		40 X 6	Y	12.5	-	200

Tutti gli articoli sono di nostra produzione e non originali. Pesì e misure sono puramente indicativi e possono essere modificati senza preavviso. La riproduzione anche parziale del presente catalogo è vietata. All articles are of our production and not original. Weights and measures are approximate and may change without notice. Reproduction of this catalog is prohibited. Tous les articles sont fabriqués par nous-mêmes et non d'origine. Les poids et mesurés sont approximatifs et peuvent changer sans préavis. Alle artikel werden von uns selbst hergestellt und nicht original. Masse und gewichte sind richtwerte und kan ohne vorank undigung gendert werden.

COLTELLI PER TRINCIA

BLADES FOR CHOPPERS - COUTEAUX POUR BROyeurs
MESSER - CUCHILLOS PARA TRITURADORAS

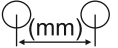

Codice Ref. Re. Codigo	Marca e descrizione modello Brand name and model description Constructeur et description du modèle Marke und Modell Beschreibung Marca y modelo de descripción	Quote/ Dimensions Abmessungen Dimensiones (mm) 	Piatto Plate Platte Plaque 	Curvatura Curvature Corbure Krummung 	Foro Hole Trou Locher Hoyos Ø (mm)	Interasse Cent. Distance Achsenabstand Distancia entre ejes 	Peso Weight Gewicht Poids 
------------------------	--	---	---	--	---	---	---

EPOKE

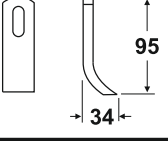
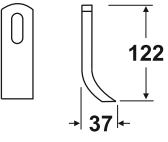
TEPK01	COLTELLO SPATOLA ASOLA		40 X 10	C	34 X 16	-	700
TEPK02	COLTELLO SPATOLA ASOLA		40 X 10	C	40 X 15	-	780

FALC

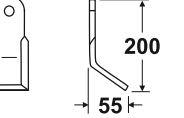
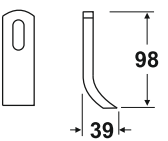
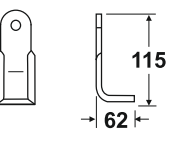



TFAL01	COLTELLO DIRITTO ALCE		60 X 10	D	25.5	-	850
TFAL02	COLTELLO Y ALCE Cod Orig: 430151		60 X 10	Y	25.5	-	930
TFAL03	COLTELLO SPATOLA ASOLA FP Cod Orig: 470307		40 X 12	C	36 X 16	-	420
TFAL04	COLTELLO COBRA		60 X 10	SQ	25.5	-	710

Tutti gli articoli sono di nostra produzione e non originali. Pesi e misure sono puramente indicativi e possono essere modificati senza preavviso. La riproduzione anche parziale del presente catalogo è vietata. All articles are of our production and not original. Weights and measures are approximate and may change without notice. Reproduction of this catalog is prohibited. Tous les articles sont fabriqués par nous-mêmes et non d'origine. Les poids et mesures sont approximatifs et peuvent changer sans préavis. Alle Artikel werden von uns selbst hergestellt und nicht original. Masse und Gewichte sind Richtwerte und können ohne Vorankündigung geändert werden.

COLTELLI PER TRINCIA

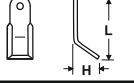
BLADES FOR CHOPPERS - COUTEAUX POUR BROyeurs
MESSER - CUCHILLOS PARA TRITURADORAS



Codice Ref. Re. Codigo	Marca e descrizione modello Brand name and model description Constructeur et description du modèle Marke und Modell Beschreibung Marca y modelo de descripción	Quote/ Dimensions Abmessungen Dimensiones (mm) 	Piatto Plate Platte Plaque 	Curvatura Curvature Corbure Krummung 	Foro Hole Trou Locher Hoyos Ø (mm)	Interasse Cent. Distance Achsenabstand Distancia entre ejes 	Peso Weight Gewicht Poids 
---------------------------------	--	---	---	--	---	---	---

FALCONERO

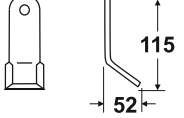
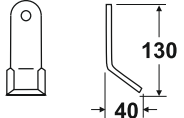
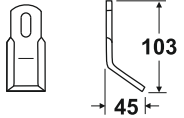
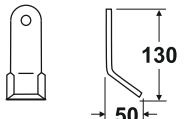
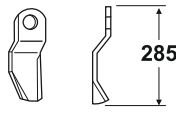
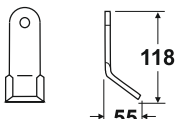
TFLN01	COLTELLO Y		40 X 8	Y	16.5	-	310
TFLN02	COLTELLO Y RUOTA INTERFILA		35 X 5	Y	14.5	-	105
TFLN03	COLTELLO Y ASOLA		40 X 8	Y	30 X 14	-	250
TFLN04	COLTELLO Y		40 X 8	Y	20.5	-	300
TFLN05	COLTELLO RUOTA INTERFILA ROTAZIONE SX		60 X 8	D	25.5	-	1040
TFLN06	COLTELLO Y		40 X 8	Y	20.5	-	330

FERABOLI

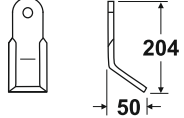



TFEB01	COLTELLO Y		60 X 8	Y	25.5	-	740
--------	------------	---	--------	---	------	---	-----

Tutti gli articoli sono di nostra produzione e non originali. Pesi e misure sono puramente indicativi e possono essere modificati senza preavviso. La riproduzione anche parziale del presente catalogo è vietata. All articles are of our production and not original. Weights and measures are approximate and may change without notice. Reproduction of this catalog is prohibited. Tous les articles sont fabriqués par nous-mêmes et non d'origine. Les poids et mesures sont approximatifs et peuvent changer sans préavis. Alle Artikel werden von uns selbst hergestellt und nicht original. Masse und Gewichte sind Richtwerte und können ohne Vorankündigung geändert werden.

COLTELLI PER TRINCIA

BLADES FOR CHOPPERS - COUTEAUX POUR BROyeurs
MESSER - CUCHILLOS PARA TRITURADORAS

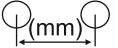
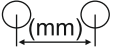

Codice Ref. Re. Codigo	Marca e descrizione modello Brand name and model description Constructeur et description du modèle Marke und Modell Beschreibung Marca y modelo de descripción	Quote/ Dimensions Abmessungen Dimensiones (mm) 	Piatto Plate Platte Plaque 	Curvatura Curvature Corbure Krummung 	Foro Hole Trou Locher Hoyos Ø (mm) 	Interasse Cent. Distance Achsenabstand Distancia entre ejes 	Peso Weight Gewicht Poids 
------------------------	--	---	---	--	--	---	---

FERRI

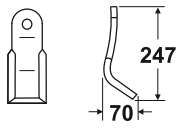
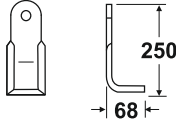
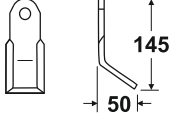
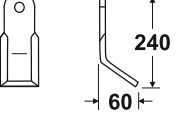
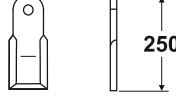
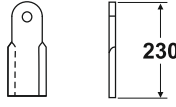
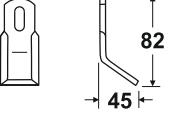
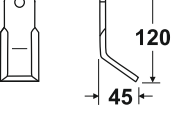
TFEI01	COLTELLO Y UNIVERSALE Cod Orig: 0901001		60 X 8	Y	25.5	-	960
TFEI02	COLTELLO Cod Orig: 0901005		60 X 8	SQ	25.5	-	1150
TFEI03	COLTELLO Y TIPO NUOVO Cod Orig: 0901003		60 X 8	Y	25.5	-	520
TFEI04	COLTELLO Y TIPO LUNGO Cod Orig: 0901004		60 X 8	Y	25.5	-	920
TFEI05	COLTELLO DIRITTO Cod Orig: 0901019		60 X 8	D	25.5	-	860
TFEI06	COLTELLO DIRITTO RUOTA INTERFILA		60 X 8	D	25.5	-	780
TFEI07	COLTELLO Y ASOLA Cod Orig: 0901049		40 X 8	Y	30 X 14	-	210
TFEI08	COLTELLO Y CENTRALE Cod Orig: 0901085		60 X 8	Y	25.5	-	440

Tutti gli articoli sono di nostra produzione e non originali. Pesi e misure sono puramente indicativi e possono essere modificati senza preavviso. La riproduzione anche parziale del presente catalogo è vietata. All articles are of our production and not original. Weights and measures are approximate and may change without notice. Reproduction of this catalog is prohibited. Tous les articles sont fabriqués par nous-même et non d'origine. Les poids et mesurés sont approximatifs et peuvent changer sans préavis. Alle artikel werden von uns selbst hergestellt und nicht original. Masse und gewichte sind richtwerte und kan ohne vorank undigung gendert werden.

COLTELLI PER TRINCIA

BLADES FOR CHOPPERS - COUTEAUX POUR BROyeurs
MESSER - CUCHILLOS PARA TRITURADORAS



Codice Ref. Re. Codigo	Marca e descrizione modello Brand name and model description Constructeur et description du modèle Marke und Modell Beschreibung Marca y modelo de descripción	Quote/ Dimensions Abmessungen Dimensiones (mm) 	Piatto Plate Platte Plaque 	Curvatura Curvature Corbure Krummung 	Foro Hole Trou Locher Hoyos Ø (mm)	Interasse Cent. Distance Achsenabstand Distancia entre ejes 	Peso Weight Gewicht Poids
------------------------	--	--	---	---	---	--	--

FERRI

TFEI09	COLTELLO Y LATERALE		60 X 8	Y	25.5	-	480
TFEI10	COLTELLO DIRITTO TS Cod Orig: 0901148		60 X 8	D	25.5	-	400
TFEI11	COLTELLO Y POLIVALENTE LEGGERO Cod Orig: 0901129		40 X 8	Y	16.5	-	350
TFEI12	COLTELLO Y SC - TZ Cod Orig: 187005		60 X 8	Y	25.5	-	520
TFEI13	COLTELLO Y ASOLA TIPO LUNGO Cod Orig: 0901168		40 X 8	Y	30 X 14	-	250
TFEI14	COLTELLO Y		40 X 8	Y	20.5	-	300
TFEI15	COLTELLO Y ASOLA		30 X 4	Y	27 X 13	-	100
TFEI16	COLTELLO DIRITTO TIG Cod Orig: 0901149		40 X 8	D	16.5	-	340

Tutti gli articoli sono di nostra produzione e non originali. Pesi e misure sono puramente indicativi e possono essere modificati senza preavviso. La riproduzione anche parziale del presente catalogo è vietata. All articles are of our production and not original. Weights and measures are approximate and may change without notice. Reproduction of this catalog is prohibited. Tous les articles sont fabriqués par nous-même mes et non d'origine. Les poids et mesurés sont approximatifs et peuvent changer sans préavis. Alle artikel werden von uns selbst hergestellt und nicht original. Masse und gewichte sind richtwerte und kan ohne vorank undigung gendert werden.

COLTELLI PER TRINCIA

BLADES FOR CHOPPERS - COUTEAUX POUR BROyeurs
MESSER - CUCHILLOS PARA TRITURADORAS



Codice Ref. Re. Codigo	Marca e descrizione modello Brand name and model description Constructeur et description du modèle Marke und Modell Beschreibung Marca y modelo de descripción	Quote/ Dimensions Abmessungen Dimensiones (mm) 	Piatto Plate Platte Plaque 	Curvatura Curvature Corbure Krummung 	Foro Hole Trou Locher Hoyos Ø (mm)	Interasse Cent. Distance Achsenabstand Distancia entre ejes 	Peso Weight Gewicht Poids
------------------------	--	--	---	---	---	--	--

FERRI

TFEI17	COLTELLO Y TJ Cod Orig: 0901146		50 X 8	Y	16.5	-	380
TFEI18	COLTELLO Y TIG - TIP POLIVALENTE Cod Orig: 0901146		40 X 8	Y	16.5	-	330
TFEI19	COLTELLO Y ASOLA Cod Orig: 0901133		40 X 5	Y	30 X 14	-	120
TFEI20	SPATOLA ASOLA		70 X 3	-	19 X 13	-	160
TFEI21	COLTELLO DIRITTO ASOLA Cod Orig: 901153		40 X 6	D	35 X 17	-	160
TFEI22	COLTELLO Y Cod Orig: 0901158		40 X 6	Y	12.5	-	250
TFEI23	COLTELLO DIRITTO Cod Orig: 0901159		40 X 6	D	12.5	-	230
TFEI24	COLTELLO Y ASOLA Cod Orig: 0901160		40 X 6	Y	30 X 14	-	160

Tutti gli articoli sono di nostra produzione e non originali. Pesi e misure sono puramente indicativi e possono essere modificati senza preavviso. La riproduzione anche parziale del presente catalogo è vietata. All articles are of our production and not original. Weights and measures are approximate and may change without notice. Reproduction of this catalog is prohibited. Tous les articles sont fabriqués par nous-même et non d'origine. Les poids et mesurages sont approximatifs et peuvent changer sans préavis. Alle artikel werden von uns selbst hergestellt und nicht original. Masse und gewichte sind richtwerte und kan ohne vorank undigung gendert werden.

COLTELLI PER TRINCIA

BLADES FOR CHOPPERS - COUTEAUX POUR BROyeurs
MESSER - CUCHILLOS PARA TRITURADORAS



Codice Ref. Re. Codigo	Marca e descrizione modello Brand name and model description Constructeur et description du modèle Marke und Modell Beschreibung Marca y modelo de descripción	Quote/ Dimensions Abmessungen Dimensiones (mm) 	Piatto Plate Platte Plaque 	Curvatura Curvature Corbure Krummung 	Foro Hole Trou Locher Hoyos Ø (mm)	Interasse Cent. Distance Achsenabstand Distancia entre ejes 	Peso Weight Gewicht Poids
------------------------	--	--	---	---	---	--	--

FERRI

TFEI25	COLTELLO DIRITTO ASOLA Cod Orig: 0901161		40 X 6	D	30 X 14	-	115
TFEI26	COLTELLO SPATOLA ASOLA Cod Orig: 0901139		40 X 12	C	36 X 16	-	450
TFEI27	COLTELLO Y ASOLA SNODATO Cod Orig: 0901068		40 X 8	Y	35 X 17	-	260
TFEI28	COLTELLO Y ASOLA		40 X 6	Y	35 X 17	-	220
TFEI29	COLTELLO Y POLIVALENTE Cod Orig: 0901181		60 X 8	Y	25.5	-	535
TFEI30	COLTELLO Y ASOLA VIP Cod Orig: 0901171		40 X 4	Y	30 X 14	-	110

FISCHER







TFIS01	COLTELLO DX		70 X 10	D	28.5	-	1030
--------	------------------------	--	---------	---	------	---	------

Tutti gli articoli sono di nostra produzione e non originali. Pesi e misure sono puramente indicativi e possono essere modificati senza preavviso. La riproduzione anche parziale del presente catalogo è vietata. All articles are of our production and not original. Weights and measures are approximate and may change without notice. Reproduction of this catalog is prohibited. Tous les articles sont fabriqués par nous-mêmes et non d'origine. Les poids et mesurages sont approximatifs et peuvent changer sans préavis. Alle artikel werden von uns selbst hergestellt und nicht original. Masse und gewichte sind richtwerte und kan ohne vorank undigung gendert werden.

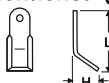
COLTELLI PER TRINCIA

BLADES FOR CHOPPERS - COUTEAUX POUR BROYEURS
MESSER - CUCHILLOS PARA TRITURADORAS



Codice Ref. Re. Codigo	Marca e descrizione modello Brand name and model description Constructeur et description du modèle Marke und Modell Beschreibung Marca y modelo de descripción	Quote/ Dimensions Abmessungen Dimensiones (mm) 	Piatto Plate Platte Plaque 	Curvatura Curvature Corbure Krummung 	Foro Hole Trou Locher Hoyos Ø (mm) 	Interasse Cent. Distance Achsenabstand Distancia entre ejes 	Peso Weight Gewicht Poids 
------------------------	--	---	---	--	--	---	---

FORIGO

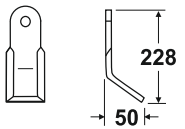
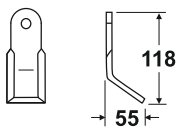
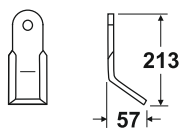
TFOR01	COLTELLO Y		60 X 7	Y	28.5	-	700
TFOR02	COLTELLO Y LEGGERO Cod Orig: 300323		40 X 8	Y	20.5	-	300
TFOR03	COLTELLO Y RINFORZATO		60 X 8	Y	25.5	-	870

FRONTONI

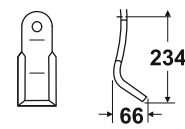
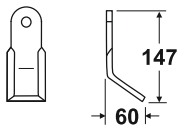
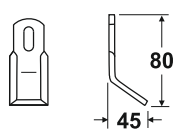
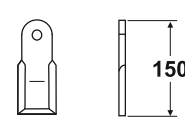
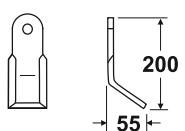
TFRO01	COLTELLO Y UNIVERSALE		60 X 8	Y	25.5	-	950
TFRO02	COLTELLO Y		60 X 8	Y	25.5	-	520
TFRO03	COLTELLO Y ASOLA		40 X 8	Y	30 X 14	-	200
TFRO04	COLTELLO DIRITTO		60 X 8	D	25.5	-	450
TFRO05	COLTELLO Y Cod Orig: 066004		60 X 10	Y	25.5	-	930

Tutti gli articoli sono di nostra produzione e non originali. Pesì e misure sono puramente indicativi e possono essere modificati senza preavviso. La riproduzione anche parziale del presente catalogo è vietata. All articles are of our production and not original. Weights and measures are approximate and may change without notice. Reproduction of this catalog is prohibited. Tous les articles sont fabriqués par nous-même mes et non d'origine. Les poids et mesurés sont approximatifs et peuvent changer sans préavis. Alle artikel werden von uns selbst hergestellt und nicht original. Masse und gewichte sind richtwerte und kan ohne vorank undigung gendert werden.

COLTELLI PER TRINCIA

BLADES FOR CHOPPERS - COUTEAUX POUR BROyeurs
MESSER - CUCHILLOS PARA TRITURADORAS



Codice Ref. Re. Codigo	Marca e descrizione modello Brand name and model description Constructeur et description du modèle Marke und Modell Beschreibung Marca y modelo de descripción	Quote/ Dimensions Abmessungen Dimensiones (mm) 	Piatto Plate Platte Plaque 	Curvatura Curvature Corbure Krummung 	Foro Hole Trou Locher Hoyos Ø (mm)	Interasse Cent. Distance Achsenabstand Distancia entre ejes 	Peso Weight Gewicht Poids
------------------------	--	--	---	---	---	--	--

FRONTONI

TFRO06	COLTELLO Y Cod Orig: 606000		40 X 8	Y	16.5	-	380
TFRO07	COLTELLO DIRITTO		40 X 8	D	16.5	-	340
TFRO08	COLTELLO DIRITTO ASOLA		40 X 5	D	30 X 14	-	120

GALGI

TGAL01	COLTELLO Y FLM 60 Cod Orig: F075400		30 X 4	Y	10.5	-	120
TGAL02	COLTELLO DIRITTO		25 X 3	D	12.5	-	100

GIMAC





TGMC01	COLTELLO DIRITTO		35 X 7	D	16.5	-	300
TGMC02	COLTELLO Y ASOLA Cod Orig: 31696		40 X 6	Y	35 X 17	-	220

Tutti gli articoli sono di nostra produzione e non originali. Pesi e misure sono puramente indicativi e possono essere modificati senza preavviso. La riproduzione anche parziale del presente catalogo è vietata. All articles are of our production and not original. Weights and measures are approximate and may change without notice. Reproduction of this catalog is prohibited. Tous les articles sont fabriqués par nous-mêmes et non d'origine. Les poids et mesures sont approximatifs et peuvent changer sans préavis. Alle artikel werden von uns selbst hergestellt und nicht original. Masse und gewichte sind richtwerte und kan ohne vorank undigung gendert werden.

COLTELLI PER TRINCIA

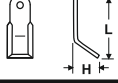
BLADES FOR CHOPPERS - COUTEAUX POUR BROyeurs
MESSER - CUCHILLOS PARA TRITURADORAS

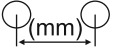

Codice Ref. Re. Codigo	Marca e descrizione modello Brand name and model description Constructeur et description du modèle Marke und Modell Beschreibung Marca y modelo de descripción	Quote/ Dimensions Abmessungen Dimensiones (mm) 	Piatto Plate Platte Plaque 	Curvatura Curvature Corbure Krummung 	Foro Hole Trou Locher Hoyos Ø (mm)	Interasse Cent. Distance Achsenabstand Distancia entre ejes 	Peso Weight Gewicht Poids 
---------------------------------	--	---	---	--	---	---	---

GL 1

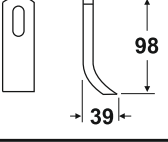
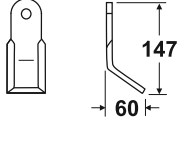
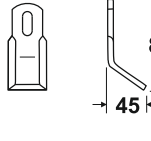
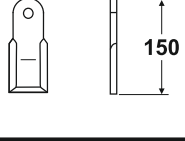
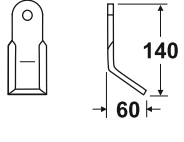
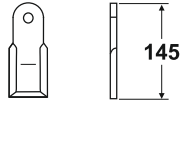
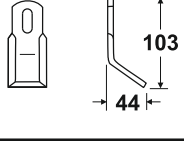
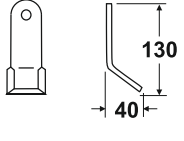



TGLU01	COLTELLO SPATOLA ASOLA		40 X 12	C	36 X 16	-	420
TGLU02	COLTELLO Y		60 X 8	Y	25.5	-	520
TGLU03	COLTELLO Y ASOLA		40 X 8	Y	30 X 14	-	200
TGLU04	COLTELLO DIRITTO		60 X 8	D	25.5	-	450
TGLU05	COLTELLO Y Cod Orig: 082111		60 X 8	Y	25.5	-	500
TGLU06	COLTELLO DIRITTO		60 X 8	D	25.5	-	450
TGLU07	COLTELLO Y ASOLA TIPO LUNGO		40 X 8	Y	35 X 17	-	250
TGLU08	COLTELLO Y BNE		40 X 8	Y	16.5	-	380

Tutti gli articoli sono di nostra produzione e non originali. Pesi e misure sono puramente indicativi e possono essere modificati senza preavviso. La riproduzione anche parziale del presente catalogo è vietata. All articles are of our production and not original. Weights and measures are approximate and may change without notice. Reproduction of this catalog is prohibited. Tous les articles sont fabriqués par nous-même mes et non d'origine. Les poids et mesurés sont approximatifs et peuvent changer sans préavis. Alle artikel werden von uns selbst hergestellt und nicht original. Masse und gewichte sind richtwerte und kan ohne vorank undigung gendert werden.

COLTELLI PER TRINCIA

BLADES FOR CHOPPERS - COUTEAUX POUR BROyeurs
MESSER - CUCHILLOS PARA TRITURADORAS

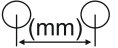
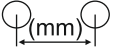

Codice Ref. Re. Codigo	Marca e descrizione modello Brand name and model description Constructeur et description du modèle Marke und Modell Beschreibung Marca y modelo de descripción	Quote/ Dimensions Abmessungen Dimensiones (mm) 	Piatto Plate Platte Plaque 	Curvatura Curvature Corbure Krummung 	Foro Hole Trou Locher Hoyos Ø (mm) 	Interasse Cent. Distance Achsenabstand Distancia entre ejes 	Peso Weight Gewicht Poids 
------------------------	--	---	---	--	--	---	---

GREEN TECHNIK

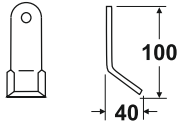
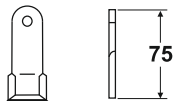
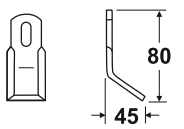
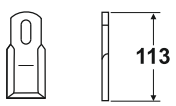
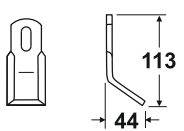
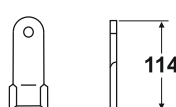
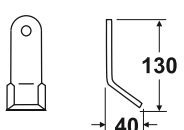
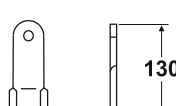



TGRT01	COLTELLO Y Cod Orig: TE031000990		40 X 5	Y	12.5	-	165
TGRT02	COLTELLO DIRITTO Cod Orig: BC41230		40 X 5	D	18.5	-	100
TGRT03	COLTELLO Y ASOLA		40 X 8	Y	30 X 14	-	200
TGRT04	COLTELLO DIRITTO ASOLA		40 X 6	D	35 X 17	-	170
TGRT05	COLTELLO Y ASOLA		40 X 8	Y	35 X 17	-	280
TGRT06	COLTELLO DIRITTO		35 X 5	D	14.5	-	190
TGRT07	COLTELLO Y		40 X 8	Y	16.5	-	380
TGRT08	COLTELLO DIRITTO		40 X 8	D	16.5	-	340

Tutti gli articoli sono di nostra produzione e non originali. Pesì e misure sono puramente indicativi e possono essere modificati senza preavviso. La riproduzione anche parziale del presente catalogo è vietata. All articles are of our production and not original. Weights and measures are approximate and may change without notice. Reproduction of this catalog is prohibited. Tous les articles sont fabriqués par nous-même mes et non d'origine. Les poids et mesurés sont approximatifs et peuvent changer sans préavis. Alle artikel werden von uns selbst hergestellt und nicht original. Masse und gewichte sind richtwerte und kan ohne vorank undigung gendert werden.

COLTELLI PER TRINCIA

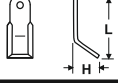
BLADES FOR CHOPPERS - COUTEAUX POUR BROyeurs
MESSER - CUCHILLOS PARA TRITURADORAS

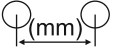

Codice Ref. Re. Codigo	Marca e descrizione modello Brand name and model description Constructeur et description du modèle Marke und Modell Beschreibung Marca y modelo de descripción	Quote/ Dimensions Abmessungen Dimensiones (mm) 	Piatto Plate Platte Plaque 	Curvatura Curvature Corbure Krummung 	Foro Hole Trou Locher Hoyos Ø (mm)	Interasse Cent. Distance Achsenabstand Distancia entre ejes 	Peso Weight Gewicht Poids 
---------------------------------	--	---	---	--	---	---	---

GREEN TECHNIK

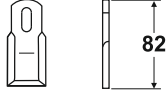
TGRT09	COLTELLO DIRITTO ASOLA		40 X 5	D	30 X 14	-	120
--------	---------------------------	---	--------	---	---------	---	-----

GRILLO

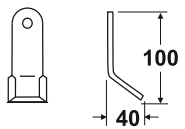
TGRI01	COLTELLO Y		40 X 5	Y	12.5	-	160
--------	------------	--	--------	---	------	---	-----

HERMES

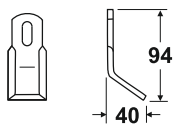
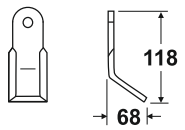
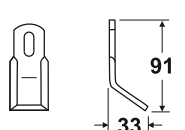



THRM01	COLTELLO Y ASOLA EM - 80		40 X 5	Y	23 X 11	-	150
THRM02	COLTELLO Y CASTOR		50 X 10	Y	16.5	-	500
THRM03	COLTELLO Y ASOLA		30 X 5	Y	23 X 10	-	110

Tutti gli articoli sono di nostra produzione e non originali. Pesì e misure sono puramente indicativi e possono essere modificati senza preavviso. La riproduzione anche parziale del presente catalogo è vietata. All articles are of our production and not original. Weights and measures are approximate and may change without notice. Reproduction of this catalog is prohibited. Tous les articles sont fabriqués par nous-mêmes et non d'origine. Les poids et mesures sont approximatifs et peuvent changer sans préavis. Alle artikel werden von uns selbst hergestellt und nicht original. Masse und gewichte sind richtwerte und kan ohne vorank undigung gendert werden.

COLTELLI PER TRINCIA

BLADES FOR CHOPPERS - COUTEAUX POUR BROyeurs
MESSER - CUCHILLOS PARA TRITURADORAS

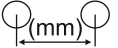
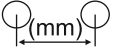

Codice Ref. Re. Codigo	Marca e descrizione modello Brand name and model description Constructeur et description du modèle Marke und Modell Beschreibung Marca y modelo de descripción	Quote/ Dimensions Abmessungen Dimensiones (mm) 	Piatto Plate Platte Plaque 	Curvatura Curvature Corbure Krummung 	Foro Hole Trou Locher Hoyos Ø (mm) 	Interasse Cent. Distance Achsenabstand Distancia entre ejes 	Peso Weight Gewicht Poids 
------------------------	--	---	---	--	--	---	---

HMF FREI

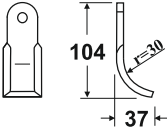
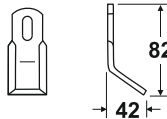
THMF01	COLTELLO CURVO		40 X 10	C	16.5	-	330
THMF02	COLTELLO Y ASOLA		40 X 5	Y	30 X 14	-	140

HOWARD ROTAVATOR

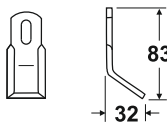
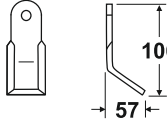
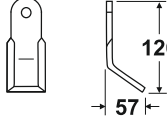
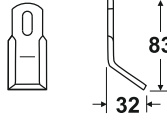



THWR01	COLTELLO Y ASOLA		40 X 6	Y	31 X 17	-	130
THWR02	COLTELLO Y		50 X 10	Y	25.5	-	440
THWR03	COLTELLO Y TIPO LUNGO		50 X 10	Y	25.5	-	500
THWR04	COLTELLO Y ASOLA		45 X 6	Y	31 X 17	-	150

Tutti gli articoli sono di nostra produzione e non originali. Pesì e misure sono puramente indicativi e possono essere modificati senza preavviso. La riproduzione anche parziale del presente catalogo è vietata. All articles are of our production and not original. Weights and measures are approximate and may change without notice. Reproduction of this catalog is prohibited. Tous les articles sont fabriqués par nous-mêmes et non d'origine. Les poids et mesures sont approximatifs et peuvent changer sans préavis. Alle Artikel werden von uns selbst hergestellt und nicht original. Masse und Gewichte sind Richtwerte und können ohne Vorankündigung geändert werden.

COLTELLI PER TRINCIA

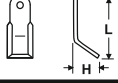
BLADES FOR CHOPPERS - COUTEAUX POUR BROyeurs
MESSER - CUCHILLOS PARA TRITURADORAS

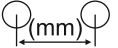
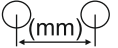

Codice Ref. Re. Codigo	Marca e descrizione modello Brand name and model description Constructeur et description du modèle Marke und Modell Beschreibung Marca y modelo de descripción	Quote/ Dimensions Abmessungen Dimensiones (mm) 	Piatto Plate Platte Plaque 	Curvatura Curvature Corbure Krummung 	Foro Hole Trou Locher Hoyos Ø (mm) 	Interasse Cent. Distance Achsenabstand Distancia entre ejes 	Peso Weight Gewicht Poids 
---------------------------------	--	---	---	--	--	---	---

HUMUS

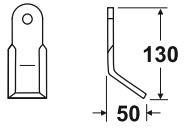
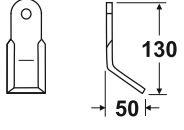
THUM01	COLTELLO Y		50 X 6	Y	16.5	-	340
THUM02	COLTELLO Y PESANTE		50 X 8	Y	16.5	-	450

HYMACH

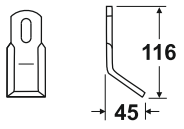
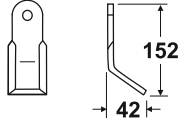
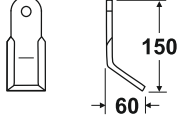
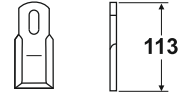
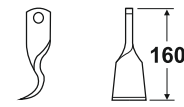



THYM01	COLTELLO Y ASOLA		40 X 8	Y	30 X 14	-	280
THYM02	COLTELLO Y 024 G		50 X 8	Y	20.5	-	480
THYM03	COLTELLO Y		60 X 8	Y	25.5	-	600
THYM04	COLTELLO DIRITTO ASOLA		40 X 6	D	35 X 17	-	200
THYM05	DENTE GIRATO 024 S		50 X 12	D	20.5	-	700

Tutti gli articoli sono di nostra produzione e non originali. Pesi e misure sono puramente indicativi e possono essere modificati senza preavviso. La riproduzione anche parziale del presente catalogo è vietata. All articles are of our production and not original. Weights and measures are approximate and may change without notice. Reproduction of this catalog is prohibited. Tous les articles sont fabriqués par nous-mêmes et non d'origine. Les poids et mesures sont approximatifs et peuvent changer sans préavis. Alle Artikel werden von uns selbst hergestellt und nicht original. Masse und Gewichte sind Richtwerte und können ohne Vorankündigung geändert werden.

COLTELLI PER TRINCIA

BLADES FOR CHOPPERS - COUTEAUX POUR BROyeurs
MESSER - CUCHILLOS PARA TRITURADORAS

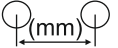

Codice Ref. Re. Codigo	Marca e descrizione modello Brand name and model description Constructeur et description du modèle Marke und Modell Beschreibung Marca y modelo de descripción	Quote/ Dimensions Abmessungen Dimensiones (mm) 	Piatto Plate Platte Plaque 	Curvatura Curvature Corbure Krummung 	Foro Hole Trou Locher Hoyos Ø (mm)	Interasse Cent. Distance Achsenabstand Distancia entre ejes 	Peso Weight Gewicht Poids 
------------------------	--	---	---	--	---	---	---

HYMACH

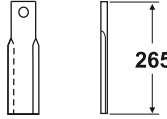
THYM06	LAMA ROTANTE		80 X 13	D	24.5	-	2150
--------	--------------	---	---------	---	------	---	------

JOHN DEERE

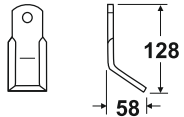
TJDE01	COLTELLO Y		60 X 8	Y	19.5	-	500
--------	------------	---	--------	---	------	---	-----

KONGSKILDE

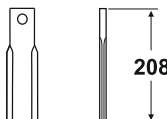
TKNG01	COLTELLO ROTOR		50 X 12	D	17	-	900
--------	----------------	---	---------	---	----	---	-----

KUHN

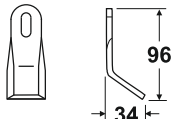
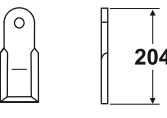



TKUH01	COLTELLO Y ASOLA		35 X 8	Y	30 X 14	-	200
TKUH02	COLTELLO DIRITTO Cod Orig: 6060002		60 X 10	D	25.5	-	850

Tutti gli articoli sono di nostra produzione e non originali. Pesi e misure sono puramente indicativi e possono essere modificati senza preavviso. La riproduzione anche parziale del presente catalogo è vietata. All articles are of our production and not original. Weights and measures are approximate and may change without notice. Reproduction of this catalog is prohibited. Tous les articles sont fabriqués par nous-mêmes et non d'origine. Les poids et mesures sont approximatifs et peuvent changer sans préavis. Alle artikel werden von uns selbst hergestellt und nicht original. Masse und gewichte sind richtwerte und kan ohne vorank undigung gendert werden.

COLTELLI PER TRINCIA

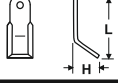
BLADES FOR CHOPPERS - COUTEAUX POUR BROyeurs
MESSER - CUCHILLOS PARA TRITURADORAS

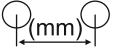

Codice Ref. Re. Codigo	Marca e descrizione modello Brand name and model description Constructeur et description du modèle Marke und Modell Beschreibung Marca y modelo de descripción	Quote/ Dimensions Abmessungen Dimensiones (mm) 	Piatto Plate Platte Plaque 	Curvatura Curvature Corbure Krummung 	Foro Hole Trou Locher Hoyos Ø (mm)	Interasse Cent. Distance Achsenabstand Distancia entre ejes 	Peso Weight Gewicht Poids 
------------------------	--	---	---	--	---	---	---

KUHN

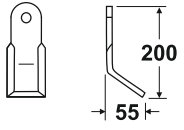
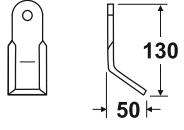
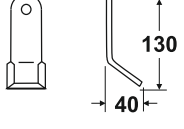
TKUH03	COLTELLO Y Cod Orig: 6060004		60 X 10	Y	25.5	-	930
TKUH04	COLTELLO Y BNA Cod Orig: 6060009		50 X 10	Y	20.5	-	480
TKUH05	COLTELLO Y BNE Cod Orig: 6060000		40 X 8	Y	16.5	-	380

LAGARDE

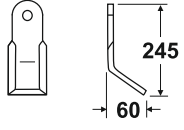
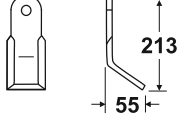
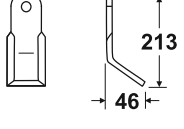
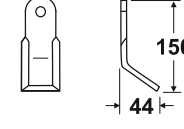



TLAG01	COLTELLO Y Cod Orig: 134301		60 X 8	Y	25.5	-	950
TLAG02	COLTELLO Y		60 X 6	Y	25.5	-	700
TLAG03	COLTELLO Y TIPO LUNGO		60 X 7	Y	25.5	-	710
TLAG04	COLTELLO Y		50 X 10	Y	18.5	-	500

Tutti gli articoli sono di nostra produzione e non originali. Pesi e misure sono puramente indicativi e possono essere modificati senza preavviso. La riproduzione anche parziale del presente catalogo è vietata. All articles are of our production and not original. Weights and measures are approximate and may change without notice. Reproduction of this catalog is prohibited. Tous les articles sont fabriqués par nous-mêmes et non d'origine. Les poids et mesurent approximatifs et peuvent changer sans préavis. Alle artikel werden von uns selbst hergestellt und nicht original. Masse und gewichte sind richtwerte und kan ohne vorank undigung gendert werden.

COLTELLI PER TRINCIA

BLADES FOR CHOPPERS - COUTEAUX POUR BROyeurs
MESSER - CUCHILLOS PARA TRITURADORAS

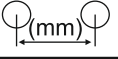
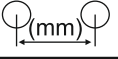

Codice Ref. Re. Codigo	Marca e descrizione modello Brand name and model description Constructeur et description du modèle Marke und Modell Beschreibung Marca y modelo de descripción	Quote/ Dimensions Abmessungen Dimensiones (mm) 	Piatto Plate Platte Plaque 	Curvatura Curvature Corbure Krummung 	Foro Hole Trou Locher Hoyos Ø (mm) 	Interasse Cent. Distance Achsenabstand Distancia entre ejes 	Peso Weight Gewicht Poids 
------------------------	--	---	---	--	--	---	---

LAGARDE

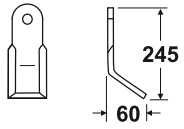
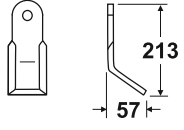
TLAG05	COLTELLO Y		60 X 7	Y	25.5	-	830
TLAG06	COLTELLO Y		60 X 7	Y	25.5	-	850

MALETTI KVERNELAND

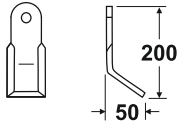
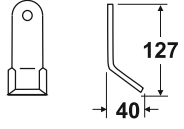
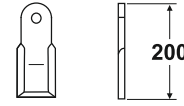
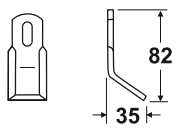
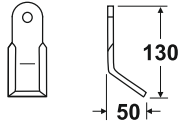
TMAL01	COLTELLO Y FX Cod Orig: 6400080		50 X 10	Y	16.5	-	800
TMAL02	COLTELLO Y FM - FH Cod Orig: 6200080		40 X 5	Y	14.5	-	200
TMAL03	COLTELLO DIRITTO FX Cod Orig: 6400079		50 X 10	D	16.5	-	780
TMAL04	COLTELLO Y ASOLA FM - FH PER SASSI Cod Orig: 6200078		40 X 5	Y	26 X 14	-	120
TMAL05	COLTELLO Y Cod Orig: 7800080		40 X 10	Y	16.5	-	420

Tutti gli articoli sono di nostra produzione e non originali. Pesi e misure sono puramente indicativi e possono essere modificati senza preavviso. La riproduzione anche parziale del presente catalogo è vietata. All articles are of our production and not original. Weights and measures are approximate and may change without notice. Reproduction of this catalog is prohibited. Tous les articles sont fabriqués par nous-mêmes et non d'origine. Les poids et mesures sont approximatifs et peuvent changer sans préavis. Alle artikel werden von uns selbst hergestellt und nicht original. Masse und gewichte sind richtwerte und kan ohne vorank undigung gendert werden.

COLTELLI PER TRINCIA

BLADES FOR CHOPPERS - COUTEAUX POUR BROyeurs
MESSER - CUCHILLOS PARA TRITURADORAS



Codice Ref. Re. Codigo	Marca e descrizione modello Brand name and model description Constructeur et description du modèle Marke und Modell Beschreibung Marca y modelo de descripción	Quote/ Dimensions Abmessungen Dimensiones (mm) 	Piatto Plate Platte Plaque 	Curvatura Curvature Corbure Krummung 	Foro Hole Trou Locher Hoyos Ø (mm)	Interasse Cent. Distance Achsenabstand Distancia entre ejes 	Peso Weight Gewicht Poids
------------------------	--	--	---	---	---	--	--

MALETTI KVERNELAND

TMAL06	COLTELLO Y Cod Orig: 6101080		35 X 3	Y	10.5	-	110
TMAL07	COLTELLO Y FH PESANTE		40 X 10	Y	14.5	-	400
TMAL08	COLTELLO Y		70 X 10	Y	16.5	-	560

MAROLIN

TMRL01	COLTELLO Y ASOLA		40 X 5	Y	26 X 14	-	120
TMRL02	COLTELLO Y ASOLA TIPO CORTO		40 X 8	Y	30 X 14	-	200

MASCHIO





TMAS01	COLTELLO Y		60 X 10	Y	20.5	-	660
--------	------------	--	---------	---	------	---	-----

Tutti gli articoli sono di nostra produzione e non originali. Pesi e misure sono puramente indicativi e possono essere modificati senza preavviso. La riproduzione anche parziale del presente catalogo è vietata. All articles are of our production and not original. Weights and measures are approximate and may change without notice. Reproduction of this catalog is prohibited. Tous les articles sont fabriqués par nous-mêmes et non d'origine. Les poids et mesures sont approximatifs et peuvent changer sans préavis. Alle artikel werden von uns selbst hergestellt und nicht original. Masse und gewichte sind richtwerte und kan ohne vorank undigung gendert werden.

COLTELLI PER TRINCIA

BLADES FOR CHOPPERS - COUTEAUX POUR BROyeurs
MESSER - CUCHILLOS PARA TRITURADORAS

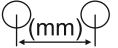

Codice Ref. Re. Codigo	Marca e descrizione modello Brand name and model description Constructeur et description du modèle Marke und Modell Beschreibung Marca y modelo de descripción	Quote/ Dimensions Abmessungen Dimensiones (mm) 	Piatto Plate Platte Plaque 	Curvatura Curvature Corbure Krummung 	Foro Hole Trou Locher Hoyos Ø (mm)	Interasse Cent. Distance Achsenabstand Distancia entre ejes 	Peso Weight Gewicht Poids 
------------------------	--	---	---	--	---	---	---

MASCHIO

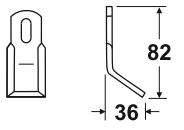
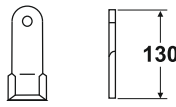
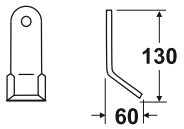
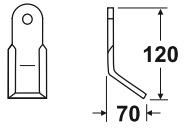
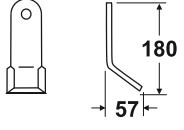
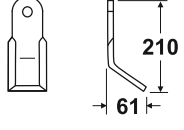
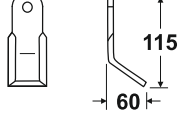
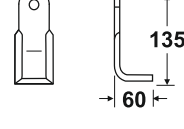



TMAS02	COLTELLO Y ASOLA BA Cod Orig: T18004060		40 X 5	Y	30 X 14	-	140
TMAS03	COLTELLO DIRITTO BL - BE - BC - BELLA VITA - BRAVA Cod Orig: T21004050		45 X 8	D	16.5	-	340
TMAS04	COLTELLO Y BL - BE - BC - BELLA VITA - BRAVA Cod Orig: T21004040		45 X 8	Y	16.5	-	360
TMAS05	COLTELLO Y TIPO CORTO		60 X 10	Y	20.5	-	660
TMAS06	COLTELLO Y LEGGERO		50 X 10	Y	20.5	-	550
TMAS07	COLTELLO Y CL - ML - MS - LEOPARD GEMELLA - GRIFONE Cod Orig: T40005142		60 X 8	Y	25.5	-	740
TMAS08	COLTELLO Y BISONTE - GIRAFFA - CR CORAZZA - TIGRE GIRAFFONA Cod Orig: M03400406		50 X 10	Y	20.5	-	460
TMAS09	COLTELLO BC - BE - BL TIPO BASSO Cod Orig: T21004042		45 X 8	SQ	16.5	-	410

Tutti gli articoli sono di nostra produzione e non originali. Pesi e misure sono puramente indicativi e possono essere modificati senza preavviso. La riproduzione anche parziale del presente catalogo è vietata. All articles are of our production and not original. Weights and measures are approximate and may change without notice. Reproduction of this catalog is prohibited. Tous les articles sont fabriqués par nous-mêmes et non d'origine. Les poids et mesures sont approximatifs et peuvent changer sans préavis. Alle Artikel werden von uns selbst hergestellt und nicht original. Masse und Gewichte sind Richtwerte und können ohne Vorankündigung geändert werden.

COLTELLI PER TRINCIA

BLADES FOR CHOPPERS - COUTEAUX POUR BROyeurs
MESSER - CUCHILLOS PARA TRITURADORAS

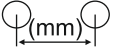

Codice Ref. Re. Codigo	Marca e descrizione modello Brand name and model description Constructeur et description du modèle Marke und Modell Beschreibung Marca y modelo de descripción	Quote/ Dimensions Abmessungen Dimensiones (mm) 	Piatto Plate Platte Plaque 	Curvatura Curvature Corbure Krummung 	Foro Hole Trou Locher Hoyos Ø (mm)	Interasse Cent. Distance Achsenabstand Distancia entre ejes 	Peso Weight Gewicht Poids 
------------------------	--	---	---	--	---	---	---

MASCHIO

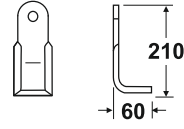
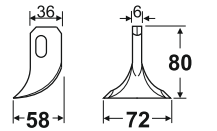
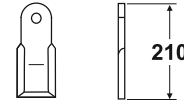
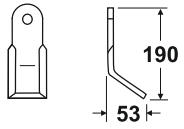
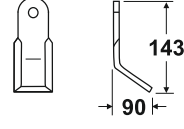
TMA10	COLTELLO CL - ML - MS LEOPARD - GRIFONE Cod Orig: T40004068		60 X 8	SQ	25.5	-	800
TMA11	SPATOLA ASOLA Cod Orig: T18004085		70 X 3	-	19 X 13	-	160
TMA12	COLTELLO DIRITTO CL - ML - MS - LEOPARD GRIFONE - GEMELLA CHIARA - TORNADO Cod Orig: 40005141		60 X 8	D	25.5	-	700
TMA13	COLTELLO Y TIPO CORTO		60 X 8	Y	25.5	-	700
TMA16	COLTELLO Y BIRBA - FURBA Cod Orig: M48400406		40 X 6	Y	14.5	-	180

MEAT

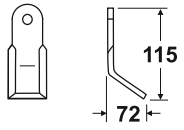
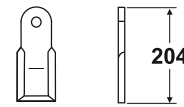



TMEA01	COLTELLO Y TSAP Cod Orig: 01844		50 X 10	Y	18.5	-	500
TMEA02	COLTELLO DIRITTO TS 160 - 300		60 X 10	D	25.5	-	850

Tutti gli articoli sono di nostra produzione e non originali. Pesi e misure sono puramente indicativi e possono essere modificati senza preavviso. La riproduzione anche parziale del presente catalogo è vietata. All articles are of our production and not original. Weights and measures are approximate and may change without notice. Reproduction of this catalog is prohibited. Tous les articles sont fabriqués par nous-même mes et non d'origine. Les poids et mesurés sont approximatifs et peuvent changer sans préavis. Alle artikel werden von uns selbst hergestellt und nicht original. Masse und gewichte sind richtwerte und kan ohne vorank undigung gendert werden.

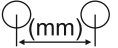
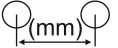

COLTELLI PER TRINCIA

BLADES FOR CHOPPERS - COUTEAUX POUR BROyeurs
MESSER - CUCHILLOS PARA TRITURADORAS

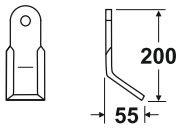
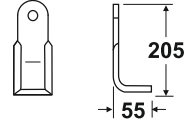
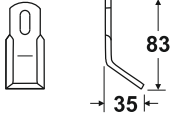

Codice Ref. Re. Codigo	Marca e descrizione modello Brand name and model description Constructeur et description du modèle Marke und Modell Beschreibung Marca y modelo de descripción	Quote/ Dimensions Abmessungen Dimensiones (mm) 	Piatto Plate Platte Plaque 	Curvatura Curvature Corbure Krummung 	Foro Hole Trou Locher Hoyos Ø (mm) 	Interasse Cent. Distance Achsenabstand Distancia entre ejes 	Peso Weight Gewicht Poids 
------------------------	--	---	---	--	--	---	---

MEAT

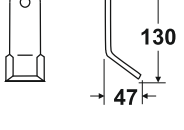
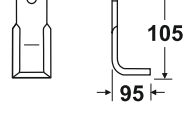
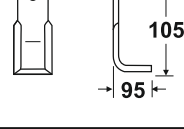
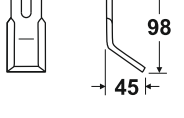
TMEA03	COLTELLO Y TS 160 - 300		60 X 10	Y	25.5	-	930
TMEA04	COLTELLO Cod Orig: 1361		60 X 10	SQ	25.5	-	1000
TMEA05	COLTELLO Y ASOLA		40 X 5	Y	27 X 13	-	120
TMEA06	COLTELLO Y TSAP Cod Orig: 259007		50 X 10	Y	16.5	-	540
TMEA07	COLTELLO Y TSAP		40 X 10	Y	20.5	-	400
TMEA08	COLTELLO		55 X 15	SQ	18.5	-	1080
TMEA09	COLTELLO		55 X 15	SQ	16.5	-	1090
TMEA10	COLTELLO Y ASOLA TSA - R - 150 Cod Orig:2491		40 X 8	Y	14 X 30	-	280

Tutti gli articoli sono di nostra produzione e non originali. Pesi e misure sono puramente indicativi e possono essere modificati senza preavviso. La riproduzione anche parziale del presente catalogo è vietata. All articles are of our production and not original. Weights and measures are approximate and may change without notice. Reproduction of this catalog is prohibited. Tous les articles sont fabriqués par nous-même mes et non d'origine. Les poids et mesurssont approximatifs et peuvent changer sans preavis. Alle artikel werden von uns selbst hergestellt und nicht original. Masse und gewichte sind richtwerte und kan ohne vorank undigung gendert werden.

COLTELLI PER TRINCIA

BLADES FOR CHOPPERS - COUTEAUX POUR BROYEURS
MESSER - CUCHILLOS PARA TRITURADORAS



Codice Ref. Re. Codigo	Marca e descrizione modello Brand name and model description Constructeur et description du modèle Marke und Modell Beschreibung Marca y modelo de descripción	Quote/ Dimensions Abmessungen Dimensiones (mm) 	Piatto Plate Platte Plaque 	Curvatura Curvature Corbure Krummung 	Foro Hole Trou Locher Hoyos Ø (mm)	Interasse Cent. Distance Achsenabstand Distancia entre ejes 	Peso Weight Gewicht Poids
------------------------	--	--	---	---	---	--	--

MEAT

TMEA11	COLTELLO Y Cod Orig: 2832		45 X 10	Y	16.5	-	410
--------	-------------------------------------	--	---------	---	------	---	-----

MERITANO

TMER01	COLTELLO		50 X 10	SQ	22.5	-	450
--------	-----------------	--	---------	----	------	---	-----

MORELLATO

TMOR01	COLTELLO Y		40 X 5	Y	10.5	-	140
TMOR02	COLTELLO DIRITTO		40 X 5	D	10.5	-	120
TMOR03	COLTELLO DIRITTO		40 X 8	D	16.5	-	280
TMOR04	COLTELLO Y TRT - TRL Cod Orig: Cm0923		40 X 6	Y	14.5	-	240
TMOR05	COLTELLO DIRITTO Cod Orig: 102021020		40 X 6	D	14.5	-	190

Tutti gli articoli sono di nostra produzione e non originali. Pesi e misure sono puramente indicativi e possono essere modificati senza preavviso. La riproduzione anche parziale del presente catalogo è vietata. All articles are of our production and not original. Weights and measures are approximate and may change without notice. Reproduction of this catalog is prohibited. Tous les articles sont fabriqués par nous-mêmes et non d'origine. Les poids et mesures sont approximatifs et peuvent changer sans préavis. Alle artikel werden von uns selbst hergestellt und nicht original. Masse und gewichte sind richtwerte und kan ohne vorank undigung gendert werden.

COLTELLI PER TRINCIA

BLADES FOR CHOPPERS - COUTEAUX POUR BROyeurs
MESSER - CUCHILLOS PARA TRITURADORAS



Codice Ref. Re. Codigo	Marca e descrizione modello Brand name and model description Constructeur et description du modèle Marke und Modell Beschreibung Marca y modelo de descripción	Quote/ Dimensions Abmessungen Dimensiones (mm) 	Piatto Plate Platte Plaque 	Curvatura Curvature Corbure Krummung 	Foro Hole Trou Locher Hoyos Ø (mm) 	Interasse Cent. Distance Achsenabstand Distancia entre ejes 	Peso Weight Gewicht Poids
---------------------------------	--	--	---	---	---	--	--

MORELLATO

TMOR06	COLTELLO Y TRT - TRL		40 X 6	Y	14.5	-	250
--------	-------------------------	--	--------	---	------	---	-----

MORIS





TMRS01	COLTELLO Y ASOLA		40 X 8	Y	35 X 17	-	340
TMRS02	COLTELLO Y ASOLA		40 X 6	Y	30 X 14	-	200
TMRS03	COLTELLO DIRITTO ASOLA		40 X 6	D	35 X 17	-	170
TMRS04	COLTELLO DIRITTO		35 X 5	D	14.5	-	190
TMRS05	COLTELLO Y		40 X 8	Y	16.5	-	380
TMRS06	COLTELLO DIRITTO CENTRALE		40 X 8	D	16.5	-	340
TMRS07	COLTELLO DIRITTO ASOLA		40 X 5	D	30 X 14	-	120

Tutti gli articoli sono di nostra produzione e non originali. Pesi e misure sono puramente indicativi e possono essere modificati senza preavviso. La riproduzione anche parziale del presente catalogo è vietata. All articles are of our production and not original. Weights and measures are approximate and may change without notice. Reproduction of this catalog is prohibited. Tous les articles sont fabriqués par nous-mêmes et non d'origine. Les poids et mesurages sont approximatifs et peuvent changer sans préavis. Alle artikel werden von uns selbst hergestellt und nicht original. Masse und gewichte sind richtwerte und kan ohne vorank undigung gendert werden.

COLTELLI PER TRINCIA

BLADES FOR CHOPPERS - COUTEAUX POUR BROyeurs
MESSER - CUCHILLOS PARA TRITURADORAS

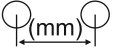

Codice Ref. Re. Codigo	Marca e descrizione modello Brand name and model description Constructeur et description du modèle Marke und Modell Beschreibung Marca y modelo de descripción	Quote/ Dimensions Abmessungen Dimensiones (mm) 	Piatto Plate Platte Plaque 	Curvatura Curvature Corbure Krummung 	Foro Hole Trou Locher Hoyos Ø (mm)	Interasse Cent. Distance Achsenabstand Distancia entre ejes 	Peso Weight Gewicht Poids 
------------------------	--	---	---	--	---	---	---

MOTT

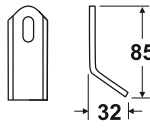
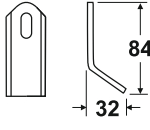
TMTT01	COLTELLO Y ASOLA		40 X 3	Y	27 X 13	-	70
TMTT02	COLTELLO Y ASOLA		40 X 4	Y	30 X 14	-	105

MULAG

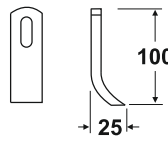
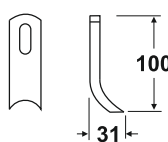
TMUL01	COLTELLO SPATOLA ASOLA		50 X 10	C	30 X 14	-	470
TMUL02	COLTELLO SPATOLA ASOLA		40 X 5	C	27 X 13	-	160

MURATORI

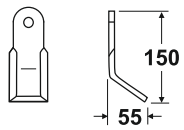
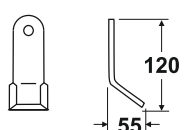
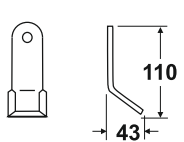
TMURO1	COLTELLO Y UNIVERSALE MT 7		60 X 10	Y	25.5	-	700
TMURO2	COLTELLO Y MT 5 - MT 6 - MT 8 MT 12 - MT 13 - MT 14		40 X 8	Y	20.5	-	300
TMURO3	COLTELLO Y MT 2 - MT 10 - MT 20 Cod Orig: 12010200		35 X 5	Y	14.5	-	200

Tutti gli articoli sono di nostra produzione e non originali. Pesi e misure sono puramente indicativi e possono essere modificati senza preavviso. La riproduzione anche parziale del presente catalogo è vietata. All articles are of our production and not original. Weights and measures are approximate and may change without notice. Reproduction of this catalog is prohibited. Tous les articles sont fabriqués par nous-même mes et non d'origine. Les poids et mesurés sont approximatifs et peuvent changer sans préavis. Alle artikel werden von uns selbst hergestellt und nicht original. Masse und gewichte sind richtwerte und kan ohne vorank undigung gendert werden.

COLTELLI PER TRINCIA

BLADES FOR CHOPPERS - COUTEAUX POUR BROyeurs
MESSER - CUCHILLOS PARA TRITURADORAS



Codice Ref. Re. Codigo	Marca e descrizione modello Brand name and model description Constructeur et description du modèle Marke und Modell Beschreibung Marca y modelo de descripción	Quote/ Dimensions Abmessungen Dimensiones (mm) 	Piatto Plate Platte Plaque 	Curvatura Curvature Corbure Krummung 	Foro Hole Trou Locher Hoyos Ø (mm)	Interasse Cent. Distance Achsenabstand Distancia entre ejes 	Peso Weight Gewicht Poids
------------------------	--	--	---	---	---	--	--

MURATORI

TMUR04	COLTELLO DIRITTO		35 X 5	D	14.5	-	180
TMUR05	SPATOLA ASOLA		70 X 3	-	19 X 13	-	160

MUTHING

TMUT01	COLTELLO SPATOLA ASOLA		50 X 12	Y	34 X 17	-	330
--------	------------------------	--	---------	---	---------	---	-----

NICOLAS

TNIC01	COLTELLO Y		60 X 10	Y	25.5	-	930
TNIC02	COLTELLO Y ASOLA Cod Orig: 36015050		40 X 5	Y	27 X 14	-	150
TNIC03	PALETTA		75 X 7	Y	12.5	35	550

NOBILI

TNOB01	COLTELLO Y UNIVERSALE BMT 10 - B 10 - B 12 Cod Orig: 16794		40 X 8	Y	16.5	-	440
--------	--	--	--------	---	------	---	-----

Tutti gli articoli sono di nostra produzione e non originali. Pesi e misure sono puramente indicativi e possono essere modificati senza preavviso. La riproduzione anche parziale del presente catalogo è vietata. All articles are of our production and not original. Weights and measures are approximate and may change without notice. Reproduction of this catalog is prohibited. Tous les articles sont fabriqués par nous-mêmes et non d'origine. Les poids et mesurent approximatifs et peuvent changer sans préavis. Alle artikel werden von uns selbst hergestellt und nicht original. Masse und gewichte sind richtwerte und kan ohne vorank undigung gendert werden.

COLTELLI PER TRINCIA

BLADES FOR CHOPPERS - COUTEAUX POUR BROyeurs
MESSER - CUCHILLOS PARA TRITURADORAS



Codice Ref. Re. Codigo	Marca e descrizione modello Brand name and model description Constructeur et description du modèle Marke und Modell Beschreibung Marca y modelo de descripción	Quote/ Dimensions Abmessungen Dimensiones (mm) 	Piatto Plate Platte Plaque 	Curvatura Curvature Corbure Krummung 	Foro Hole Trou Locher Hoyos Ø (mm)	Interasse Cent. Distance Achsenabstand Distancia entre ejes 	Peso Weight Gewicht Poids
------------------------	--	--	--------------------------------------	---	--	--	-------------------------------------

NOBILI

TNOB02	COLTELLO 189 RM - B 9 - B 12 TIPO VECCHIO		60 X 8	Y	25.5	-	940
TNOB03	COLTELLO DIRITTO BMG - BNU 02 Cod Orig: 1551000		60 X 10	D	25.5	-	850
TNOB04	COLTELLO Y BMG - BNU 01 Cod Orig: 2555004		60 X 10	Y	25.5	-	930
TNOB05	COLTELLO BMG - BNU 05 Cod Orig: 2555001		60 X 10	SQ	25.5	-	980
TNOB06	PALETTA BMG - BNU 04 Cod Orig: 2555003		80 X 7	Y	14.5	-	610
TNOB07	COLTELLO Y BNE - BNA Cod Orig: 1651018		50 X 10	Y	20.5	-	480
TNOB08	COLTELLO Y BNE Cod Orig: 1781000		40 X 8	Y	16.5	-	380
TNOB09	COLTELLO Y VKD 210		45 X 8	Y	16.5	-	400

Tutti gli articoli sono di nostra produzione e non originali. Pesi e misure sono puramente indicativi e possono essere modificati senza preavviso. La riproduzione anche parziale del presente catalogo è vietata. All articles are of our production and not original. Weights and measures are approximate and may change without notice. Reproduction of this catalog is prohibited. Tous les articles sont fabriqués par nous-mêmes et non d'origine. Les poids et mesures sont approximatifs et peuvent changer sans préavis. Alle artikel werden von uns selbst hergestellt und nicht original. Masse und gewichte sind richtwerte und kan ohne vorank undigung gendert werden.

COLTELLI PER TRINCIA

BLADES FOR CHOPPERS - COUTEAUX POUR BROyeurs
MESSER - CUCHILLOS PARA TRITURADORAS



Codice Ref. Re. Codigo	Marca e descrizione modello Brand name and model description Constructeur et description du modèle Marke und Modell Beschreibung Marca y modelo de descripción	Quote/ Dimensions Abmessungen Dimensiones (mm) 	Piatto Plate Platte Plaque 	Curvatura Curvature Corbure Krummung 	Foro Hole Trou Locher Hoyos Ø (mm)	Interasse Cent. Distance Achsenabstand Distancia entre ejes 	Peso Weight Gewicht Poids
------------------------	--	--	---	---	---	--	--

NOBILI





TNOB10	COLTELLO DIRITTO RUOTA INTERFILA		40 X 8	D	16.5	-	540
TNOB11	COLTELLO Y ASOLA BNE 08 Cod Orig: 1781017		35 X 6	Y	30 X 14	-	160
TNOB12	COLTELLO DIRITTO VKD		45 X 8	D	16.5	-	340
TNOB13	COLTELLO DIRITTO BNE		40 X 8	D	16.5	-	300
TNOB14	COLTELLO Y B 8 - B 10 - B 12 Cod Orig: 1581001		40 X 8	Y	16.5	-	460
TNOB15	COLTELLO DIRITTO BNA		50 X 10	D	20.5	-	480
TNOB18	COLTELLO TRINCIASTOCCHI		100 X 10	Y	35 X 14	-	340

Tutti gli articoli sono di nostra produzione e non originali. Pesi e misure sono puramente indicativi e possono essere modificati senza preavviso. La riproduzione anche parziale del presente catalogo è vietata. All articles are of our production and not original. Weights and measures are approximate and may change without notice. Reproduction of this catalog is prohibited. Tous les articles sont fabriqués par nous-mêmes et non d'origine. Les poids et mesures sont approximatifs et peuvent changer sans préavis. Alle artikel werden von uns selbst hergestellt und nicht original. Masse und gewichte sind richtwerte und kan ohne vorank undigung gendert werden.

COLTELLI PER TRINCIA

BLADES FOR CHOPPERS - COUTEAUX POUR BROyeurs
MESSER - CUCHILLOS PARA TRITURADORAS

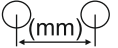

Codice Ref. Re. Codigo	Marca e descrizione modello Brand name and model description Constructeur et description du modèle Marke und Modell Beschreibung Marca y modelo de descripción	Quote/ Dimensions Abmessungen Dimensiones (mm) 	Piatto Plate Platte Plaque 	Curvatura Curvature Corbure Krummung 	Foro Hole Trou Locher Hoyos Ø (mm)	Interasse Cent. Distance Achsenabstand Distancia entre ejes 	Peso Weight Gewicht Poids 
------------------------	--	---	---	--	---	---	---

NOREMAT

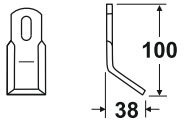
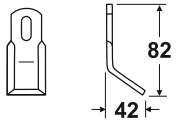
TNRM01	COLTELLO Y ASOLA Cod Orig: 139225 - 103049		40 X 5	Y	27 X 14	-	150
TNRM02	COLTELLO Y ASOLA		40 X 5	Y	30 X 14	-	140

OMA

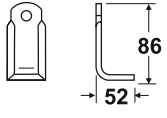
TOMA01	COLTELLO		50 X 10	SQ	15.5	-	410
--------	-----------------	---	---------	----	------	---	-----

MARV

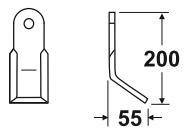
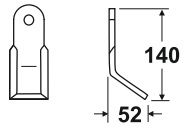
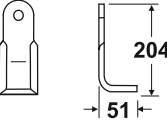
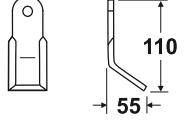



TORV01	COLTELLO Y		60 X 10	Y	25.5	-	930
TORV02	COLTELLO Y LEGGERO		50 X 10	Y	25.5	-	520
TORV03	COLTELLO		60 X 10	SQ	25.5	-	1080
TORV04	COLTELLO Y		50 X 10	Y	25.5	-	500

Tutti gli articoli sono di nostra produzione e non originali. Pesi e misure sono puramente indicativi e possono essere modificati senza preavviso. La riproduzione anche parziale del presente catalogo è vietata. All articles are of our production and not original. Weights and measures are approximate and may change without notice. Reproduction of this catalog is prohibited. Tous les articles sont fabriqués par nous-même mes et non d'origine. Les poids et mesurés sont approximatifs et peuvent changer sans préavis. Alle artikel werden von uns selbst hergestellt und nicht original. Masse und gewichte sind richtwerte und kan ohne vorank undigung gendert werden.

COLTELLI PER TRINCIA

BLADES FOR CHOPPERS - COUTEAUX POUR BROyeurs
MESSER - CUCHILLOS PARA TRITURADORAS

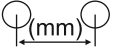
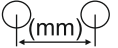

Codice Ref. Re. Codigo	Marca e descrizione modello Brand name and model description Constructeur et description du modèle Marke und Modell Beschreibung Marca y modelo de descripción	Quote/ Dimensions Abmessungen Dimensiones (mm) 	Piatto Plate Platte Plaque 	Curvatura Curvature Corbure Krummung 	Foro Hole Trou Locher Hoyos Ø (mm) 	Interasse Cent. Distance Achsenabstand Distancia entre ejes 	Peso Weight Gewicht Poids 
------------------------	--	---	---	--	--	---	---

□ MARV

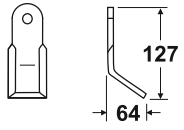
TORV05	COLTELLO Y		50 X 10	Y	25.5	-	550
--------	------------	---	---------	---	------	---	-----

□ REC

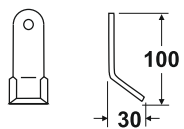
TORC01	COLTELLO Y		30 X 4	Y	10.5	-	120
--------	------------	--	--------	---	------	---	-----

□ RSI

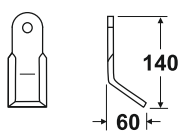
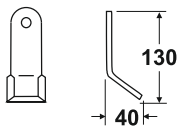
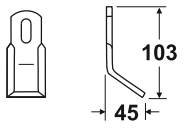
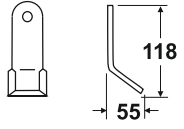
TORS01	COLTELLO Y Cod Orig: 23002		60 X 8	Y	16.5	-	520
TORS02	COLTELLO Y Cod Orig: 23000		40 X 8	Y	16.5	-	380
TORS03	COLTELLO Y ASOLA		40 X 8	Y	30 X 14	-	250
TORS04	COLTELLO Y KL - KP Cod Orig: 23004		40 X 8	Y	20.5	-	300

Tutti gli articoli sono di nostra produzione e non originali. Pesi e misure sono puramente indicativi e possono essere modificati senza preavviso. La riproduzione anche parziale del presente catalogo è vietata. All articles are of our production and not original. Weights and measures are approximate and may change without notice. Reproduction of this catalog is prohibited. Tous les articles sont fabriqués par nous-mêmes et non d'origine. Les poids et mesures sont approximatifs et peuvent changer sans préavis. Alle artikel werden von uns selbst hergestellt und nicht original. Masse und gewichte sind richtwerte und kan ohne vorank undigung gendert werden.

COLTELLI PER TRINCIA

BLADES FOR CHOPPERS - COUTEAUX POUR BROyeurs
MESSER - CUCHILLOS PARA TRITURADORAS



Codice Ref. Re. Codigo	Marca e descrizione modello Brand name and model description Constructeur et description du modèle Marke und Modell Beschreibung Marca y modelo de descripción	Quote/ Dimensions Abmessungen Dimensiones (mm) 	Piatto Plate Platte Plaque 	Curvatura Curvature Corbure Krummung 	Foro Hole Trou Locher Hoyos Ø (mm)	Interasse Cent. Distance Achsenabstand Distancia entre ejes 	Peso Weight Gewicht Poids
---------------------------------	--	--	---	---	---	--	--

ORSI





TORS05	COLTELLO Y RIVER - ENERGY - CUT Cod Orig: 23013		35 X 5	Y	14.5	-	120
TORS06	COLTELLO Y ASOLA TIPO CORTO		40 X 8	Y	35 X 17	-	200
TORS07	COLTELLO Y RIVER 500		40 X 8	Y	20.5	-	380
TORS08	COLTELLO DIRITTO		60 X 8	D	16.5	-	440
TORS09	COLTELLO Y Cod Orig: 23057		60 X 8	Y	25.5	-	720
TORS10	COLTELLO Y Cod Orig: 23043		60 X 8	Y	25.5	-	540
TORS11	DENTE GIRATO RIVER - ROTAGRI 105 Cod Orig: 23044		50 X 10	D	25.5	-	550
TORS12	COLTELLO Y UNIVERSALE Cod Orig: 30026038		60 X 8	Y	16.5	-	950

Tutti gli articoli sono di nostra produzione e non originali. Pesi e misure sono puramente indicativi e possono essere modificati senza preavviso. La riproduzione anche parziale del presente catalogo è vietata. All articles are of our production and not original. Weights and measures are approximate and may change without notice. Reproduction of this catalog is prohibited. Tous les articles sont fabriqués par nous-mêmes et non d'origine. Les poids et mesures sont approximatifs et peuvent changer sans préavis. Alle Artikel werden von uns selbst hergestellt und nicht original. Masse und Gewichte sind Richtwerte und können ohne Vorankündigung geändert werden.

COLTELLI PER TRINCIA

BLADES FOR CHOPPERS - COUTEAUX POUR BROyeurs
MESSER - CUCHILLOS PARA TRITURADORAS

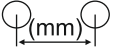
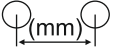

Codice Ref. Re. Codigo	Marca e descrizione modello Brand name and model description Constructeur et description du modèle Marke und Modell Beschreibung Marca y modelo de descripción	Quote/ Dimensions Abmessungen Dimensiones (mm) 	Piatto Plate Platte Plaque 	Curvatura Curvature Corbure Krummung 	Foro Hole Trou Locher Hoyos Ø (mm) 	Interasse Cent. Distance Achsenabstand Distancia entre ejes 	Peso Weight Gewicht Poids 
------------------------	--	---	---	--	--	---	---

ORSI

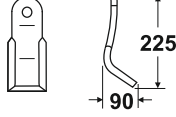
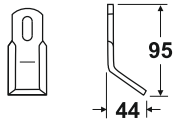
TORS13	COLTELLO Y UNIVERSALE Cod Orig: 30027218		60 X 8	Y	25.5	-	950
TORS14	COLTELLO Y ASOLA RIVER 501 LX		45 X 9	Y	38 X 16	-	210

SMA

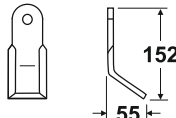
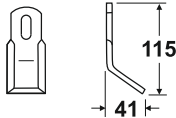
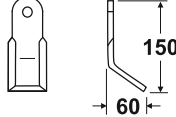
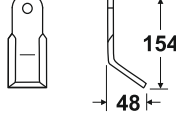



TOSM01	COLTELLO Y		60 X 8	Y	20.5	-	600
TOSM02	COLTELLO Y ASOLA		45 X 8	Y	30 X 14	-	300
TOSM03	COLTELLO Y		50 X 8	Y	20.5	-	500
TOSM04	COLTELLO Y		60 X 8	Y	25.5	-	540

Tutti gli articoli sono di nostra produzione e non originali. Pesi e misure sono puramente indicativi e possono essere modificati senza preavviso. La riproduzione anche parziale del presente catalogo è vietata. All articles are of our production and not original. Weights and measures are approximate and may change without notice. Reproduction of this catalog is prohibited. Tous les articles sont fabriqués par nous-mêmes et non d'origine. Les poids et mesures sont approximatifs et peuvent changer sans préavis. Alle Artikel werden von uns selbst hergestellt und nicht original. Masse und Gewichte sind Richtwerte und können ohne Vorankündigung geändert werden.

COLTELLI PER TRINCIA

BLADES FOR CHOPPERS - COUTEAUX POUR BROyeurs
MESSER - CUCHILLOS PARA TRITURADORAS

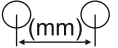
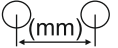

Codice Ref. Re. Codigo	Marca e descrizione modello Brand name and model description Constructeur et description du modèle Marke und Modell Beschreibung Marca y modelo de descripción	Quote/ Dimensions Abmessungen Dimensiones (mm) 	Piatto Plate Platte Plaque 	Curvatura Curvature Corbure Krummung 	Foro Hole Trou Locher Hoyos Ø (mm) 	Interasse Cent. Distance Achsenabstand Distancia entre ejes 	Peso Weight Gewicht Poids 
------------------------	--	---	--	--	---	---	--

PALLADINO

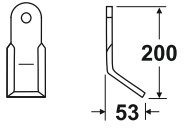
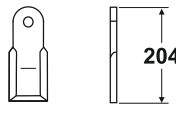
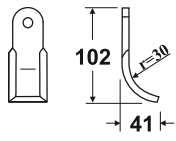
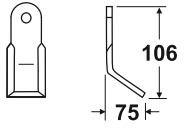
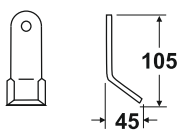
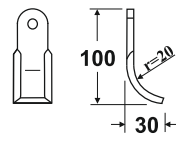
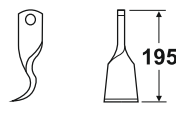
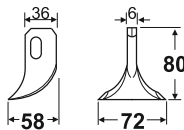
TPLD01	COLTELLO Y TSM Cod Orig: 560111		60 X 8	Y	25.5	-	740
TPLD02	COLTELLO DIRITTO		60 X 8	D	25.5	-	700
TPLD03	COLTELLO CURVO TIPO LUNGO Cod Orig: 560109		40 X 10	C	16.5	-	320
TPLD04	COLTELLO Y PESANTE Cod Orig: 560151		50 X 10	Y	16.5	-	580
TPLD05	COLTELLO Y LEGGERO TSL - TSL Cod Orig: 560114C		40 X 5	Y	12.5	-	160
TPLD06	COLTELLO CURVO TIPO CORTO Cod Orig: 560110		40 X 10	C	16.5	-	300
TPLD07	DENTE GIRATO Cod Orig: 560132		50 X 8	D	25.5	-	560
TPLD08	SPATOLA ASOLA Cod Orig: 560136		70 X 3	-	19 X 13	-	160

Tutti gli articoli sono di nostra produzione e non originali. Pesi e misure sono puramente indicativi e possono essere modificati senza preavviso. La riproduzione anche parziale del presente catalogo è vietata. All articles are of our production and not original. Weights and measures are approximate and may change without notice. Reproduction of this catalog is prohibited. Tous les articles sont fabriqués par nous-mêmes et non d'origine. Les poids et mesures sont approximatifs et peuvent changer sans préavis. Alle Artikel werden von uns selbst hergestellt und nicht original. Masse und Gewichte sind Richtwerte und können ohne Vorankündigung geändert werden.

COLTELLI PER TRINCIA

BLADES FOR CHOPPERS - COUTEAUX POUR BROyeurs
MESSER - CUCHILLOS PARA TRITURADORAS



Codice Ref. Re. Codice	Marca e descrizione modello Brand name and model description Constructeur et description du modèle Marke und Modell Beschreibung Marca y modelo de descripción	Quote/ Dimensions Abmessungen Dimensiones (mm) 	Piatto Plate Platte Plaque 	Curvatura Curvature Corbure Krummung 	Foro Hole Trou Locher Hoyos Ø (mm) 	Interasse Cent. Distance Achsenabstand Distancia entre ejes 	Peso Weight Gewicht Poids
------------------------	--	--	---	---	---	--	--

PALMESE

TPLM01	COLTELLO		40 X 5	SQ	12.5	-	220
TPLM02	COLTELLO Y UNIVERSALE ASOLA		40 X 8	Y	35 X 17	-	320

PEGORARO

TPEG01	COLTELLO Y Cod Orig: 9119		60 X 8	Y	25.5	-	740
TPEG02	COLTELLO DIRITTO Cod Orig: 9118		60 X 8	D	25.5	-	700
TPEG03	COLTELLO CURVO LEGGERO		40 X 10	C	16.5	-	320

PERUGINI CONCEPT

TPERO1	COLTELLO Y UNIVERSALE TT - MT - KT TIPO NUOVO Cod Orig: 450414		60 X 8	Y	25.5	-	515
--------	--	--	--------	---	------	---	-----

Tutti gli articoli sono di nostra produzione e non originali. Pesi e misure sono puramente indicativi e possono essere modificati senza preavviso. La riproduzione anche parziale del presente catalogo è vietata. All articles are of our production and not original. Weights and measures are approximate and may change without notice. Reproduction of this catalog is prohibited. Tous les articles sont fabriqués par nous-mêmes et non d'origine. Les poids et mesures sont approximatifs et peuvent changer sans préavis. Alle Artikel werden von uns selbst hergestellt und nicht original. Masse und Gewichte sind Richtwerte und können ohne Vorankündigung geändert werden.

COLTELLI PER TRINCIA

BLADES FOR CHOPPERS - COUTEAUX POUR BROYEURS
MESSER - CUCHILLOS PARA TRITURADORAS



Codice Ref. Re. Codigo	Marca e descrizione modello Brand name and model description Constructeur et description du modèle Marke und Modell Beschreibung Marca y modelo de descripción	Quote/ Dimensions Abmessungen Dimensiones (mm) 	Piatto Plate Platte Plaque 	Curvatura Curvature Corbure Krummung 	Foro Hole Trou Locher Hoyos Ø (mm)	Interasse Cent. Distance Achsenabstand Distancia entre ejes 	Peso Weight Gewicht Poids
------------------------	--	--	---	---	---	--	--

PERUGINI CONCEPT

TPER02	COLTELLO Y AT - ET - XT VT - UT - US Cod Orig: 560413		40 X 8	Y	16.5	-	310
TPER03	COLTELLO Y PESANTE		60 X 10	Y	25.5	-	930

PERUZZO





TPRZ01	COLTELLO Y ASOLA		40 X 5	Y	26 X 13	-	120
TPRZ02	COLTELLO Y ASOLA		30 X 4	Y	20 X 11	-	110
TPRZ03	COLTELLO Y UNIVERSALE		60 X 8	Y	25.5	-	820
TPRZ04	COLTELLO Y ASOLA Cod Orig: 05010065		30 X 4	Y	30 X 14	-	900

Tutti gli articoli sono di nostra produzione e non originali. Pesi e misure sono puramente indicativi e possono essere modificati senza preavviso. La riproduzione anche parziale del presente catalogo è vietata. All articles are of our production and not original. Weights and measures are approximate and may change without notice. Reproduction of this catalog is prohibited. Tous les articles sont fabriqués par nous-mêmes et non d'origine. Les poids et mesures sont approximatifs et peuvent changer sans préavis. Alle Artikel werden von uns selbst hergestellt und nicht original. Masse und Gewichte sind Richtwerte und können ohne Vorankündigung geändert werden.

COLTELLI PER TRINCIA

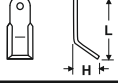
BLADES FOR CHOPPERS - COUTEAUX POUR BROYEURS
MESSER - CUCHILLOS PARA TRITURADORAS

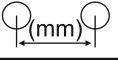
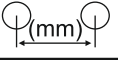

Codice Ref. Re. Codigo	Marca e descrizione modello Brand name and model description Constructeur et description du modèle Marke und Modell Beschreibung Marca y modelo de descripción	Quote/ Dimensions Abmessungen Dimensiones (mm) 	Piatto Plate Platte Plaque 	Curvatura Curvature Corbure Krummung 	Foro Hole Trou Locher Hoyos Ø (mm) 	Interasse Cent. Distance Achsenabstand Distancia entre ejes 	Peso Weight Gewicht Poids 
------------------------	--	---	---	--	--	---	---

PRE FER

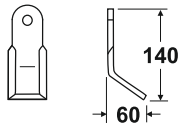
TPRE01	COLTELLO Y		60 X 8	Y	25.5	-	520
--------	------------	---	--------	---	------	---	-----

PROCOMAS - INTERMAC

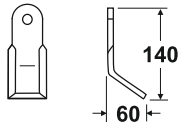
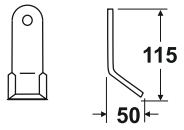
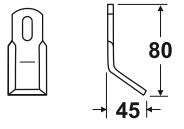
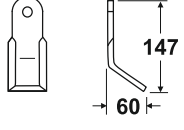
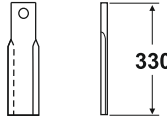
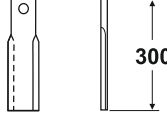
TPRC01	COLTELLO Y		60 X 6	Y	25.5	-	400
TPRC02	COLTELLO Y		40 X 6	Y	16.5	-	250
TPRC03	COLTELLO Y ASOLA		30 X 5	Y	30 X 14	-	150
TPRC04	COLTELLO Y		60 X 8	Y	25.5	-	500
TPRC05	LAMA ROTANTE DX		80 X 13	D	30.5	-	2600
TPRC06	LAMA ROTANTE DX CORTA		80 X 13	D	30.5	-	2360

Tutti gli articoli sono di nostra produzione e non originali. Pesì e misure sono puramente indicativi e possono essere modificati senza preavviso. La riproduzione anche parziale del presente catalogo è vietata. All articles are of our production and not original. Weights and measures are approximate and may change without notice. Reproduction of this catalog is prohibited. Tous les articles sont fabriqués par nous-mêmes et non d'origine. Les poids et mesures sont approximatifs et peuvent changer sans préavis. Alle Artikel werden von uns selbst hergestellt und nicht original. Masse und Gewichte sind Richtwerte und können ohne Vorankündigung geändert werden.

COLTELLI PER TRINCIA

BLADES FOR CHOPPERS - COUTEAUX POUR BROyeurs
MESSER - CUCHILLOS PARA TRITURADORAS



Codice Ref. Re. Codigo	Marca e descrizione modello Brand name and model description Constructeur et description du modèle Marke und Modell Beschreibung Marca y modelo de descripción	Quote/ Dimensions Abmessungen Dimensiones (mm) 	Piatto Plate Platte Plaque 	Curvatura Curvature Corbure Krummung 	Foro Hole Trou Locher Hoyos Ø (mm)	Interasse Cent. Distance Achsenabstand Distancia entre ejes 	Peso Weight Gewicht Poids
------------------------	--	--	---	---	---	--	--

PROCOMAS - INTERMAC

TPRC07	COLTELLO Y ASOLA Cod Orig: 015035		40 X 8	Y	30 X 14	-	240
--------	---	--	--------	---	---------	---	-----

QUIVOGNE

TQUI01	COLTELLO Cod Orig: 132194		60 X 10	SQ	25.5	-	950
TQUI02	COLTELLO Y Cod Orig: 312494		60 X 10	Y	25.5	-	570
TQUI03	COLTELLO DIRITTO Cod Orig: 108594		60 X 10	D	25.5	-	850
TQUI04	COLTELLO Y Cod Orig: 105291		60 X 10	Y	25.5	-	930

RESCIA

TRSC01	COLTELLO CURVO		40 X 5	C	14.5	-	200
--------	-----------------------	--	--------	---	------	---	-----

RINIERI

TRIN01	COLTELLO Y		60 X 8	Y	25.5	-	520
--------	-------------------	--	--------	---	------	---	-----

Tutti gli articoli sono di nostra produzione e non originali. Pesì e misure sono puramente indicativi e possono essere modificati senza preavviso. La riproduzione anche parziale del presente catalogo è vietata. All articles are of our production and not original. Weights and measures are approximate and may change without notice. Reproduction of this catalog is prohibited. Tous les articles sont fabriqués par nous-mêmes et non d'origine. Les poids et mesurent approximatifs et peuvent changer sans préavis. Alle artikel werden von uns selbst hergestellt und nicht original. Masse und gewichte sind richtwerte und kan ohne vorank undigung gendert werden.

COLTELLI PER TRINCIA

BLADES FOR CHOPPERS - COUTEAUX POUR BROYEURS
MESSER - CUCHILLOS PARA TRITURADORAS



Codice Ref. Re. Codigo	Marca e descrizione modello Brand name and model description Constructeur et description du modèle Marke und Modell Beschreibung Marca y modelo de descripción	Quote/ Dimensions Abmessungen Dimensiones (mm) 	Piatto Plate Platte Plaque 	Curvatura Curvature Corbure Krummung 	Foro Hole Trou Locher Hoyos Ø (mm)	Interasse Cent. Distance Achsenabstand Distancia entre ejes 	Peso Weight Gewicht Poids
------------------------	--	--	---	---	---	--	--

RINIERI

TRIN02	COLTELLO Y TRA - TRF		35 X 5	Y	14.5	-	120
--------	-------------------------	--	--------	---	------	---	-----

RIVIERRE CASALIS

TRIV01	COLTELLO Y		50 X 8	Y	25.5	-	660
TRIV02	COLTELLO DIRITTO		50 X 8	D	25.5	-	560

ROUSSEAU







TROU01	COLTELLO Y ASOLA Cod Orig: 525422		40 X 5	Y	27 X 13	-	150
TROU02	COLTELLO Y Cod Orig: 525402		40 X 5	Y	14.5	-	200
TROU03	COLTELLO Y ASOLA Cod Orig: 525449		40 X 8	Y	40 X 16	-	300

Tutti gli articoli sono di nostra produzione e non originali. Pesì e misure sono puramente indicativi e possono essere modificati senza preavviso. La riproduzione anche parziale del presente catalogo è vietata. All articles are of our production and not original. Weights and measures are approximate and may change without notice. Reproduction of this catalog is prohibited. Tous les articles sont fabriqués par nous-mêmes et non d'origine. Les poids et mesurent approximatifs et peuvent changer sans préavis. Alle artikel werden von uns selbst hergestellt und nicht original. Masse und gewichte sind richtwerte und kan ohne vorank undigung gendert werden.

COLTELLI PER TRINCIA

BLADES FOR CHOPPERS - COUTEAUX POUR BROyeurs
MESSER - CUCHILLOS PARA TRITURADORAS



Codice Ref. Re. Codigo	Marca e descrizione modello Brand name and model description Constructeur et description du modèle Marke und Modell Beschreibung Marca y modelo de descripción	Quote/ Dimensions Abmessungen Dimensiones (mm) 	Piatto Plate Platte Plaque 	Curvatura Curvature Corbure Krummung 	Foro Hole Trou Locher Hoyos Ø (mm) 	Interasse Cent. Distance Achsenabstand Distancia entre ejes 	Peso Weight Gewicht Poids 
------------------------	--	---	---	--	--	---	---

ROUSSEAU

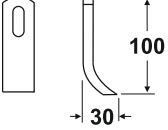
TROU04	COLTELLO SPATOLA ASOLA Cod Orig: 525426		35 X 8	C	30 X 13	-	300
--------	---	---	--------	---	---------	---	-----

SANDRI

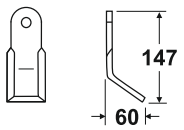
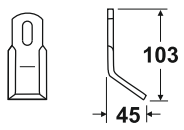
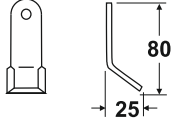
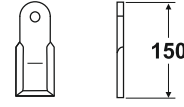
TSND01	COLTELLO Y		60 X 8	Y	25.5	-	520
TSND02	COLTELLO Y ASOLA		40 X 8	Y	30 X 14	-	250
TSND03	COLTELLO Y		35 X 5	Y	14.5	-	120
TSND04	COLTELLO DIRITTO		60 X 8	D	25.5	-	450

SAUERBURGER

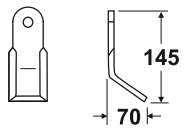



TSRB01	COLTELLO Y		60 X 8	Y	28.5	-	570
--------	-------------------	---	--------	---	------	---	-----

Tutti gli articoli sono di nostra produzione e non originali. Pesi e misure sono puramente indicativi e possono essere modificati senza preavviso. La riproduzione anche parziale del presente catalogo è vietata. All articles are of our production and not original. Weights and measures are approximate and may change without notice. Reproduction of this catalog is prohibited. Tous les articles sont fabriqués par nous-mêmes et non d'origine. Les poids et mesures sont approximatifs et peuvent changer sans préavis. Alle Artikel werden von uns selbst hergestellt und nicht original. Masse und Gewichte sind Richtwerte und können ohne Vorankündigung geändert werden.

COLTELLI PER TRINCIA

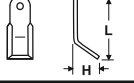
BLADES FOR CHOPPERS - COUTEAUX POUR BROyeurs
MESSER - CUCHILLOS PARA TRITURADORAS

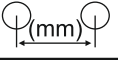
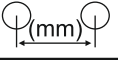

Codice Ref. Re. Codigo	Marca e descrizione modello Brand name and model description Constructeur et description du modèle Marke und Modell Beschreibung Marca y modelo de descripción	Quote/ Dimensions Abmessungen Dimensiones (mm) 	Piatto Plate Platte Plaque 	Curvatura Curvature Corbure Krummung 	Foro Hole Trou Locher Hoyos Ø (mm) 	Interasse Cent. Distance Achsenabstand Distancia entre ejes 	Peso Weight Gewicht Poids 
------------------------	--	---	---	--	--	---	---

SAUERBURGER

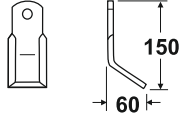
TSRB02	COLTELLO Y		60 X 8	Y	25.5	-	560
--------	------------	---	--------	---	------	---	-----

SEKO

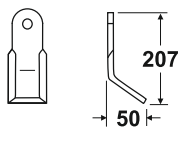
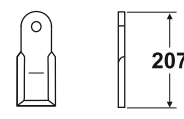
TSEK01	COLTELLO Y		60 X 7	Y	25.5	-	680
TSEK02	COLTELLO DIRITTO		60 X 7	D	25.5	-	620

SEPPI

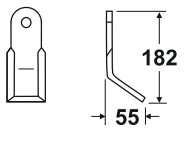
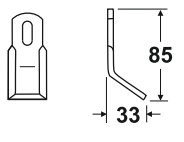
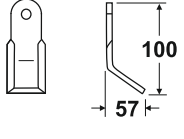



TSPI01	COLTELLO Y UNIVERSALE		60 X 8	Y	25.5	-	180
TSPI02	COLTELLO Y ASOLA		45 X 6	Y	30 X 20	-	440
TSPI03	COLTELLO Y SMW		50 X 10	Y	25.5	-	440

Tutti gli articoli sono di nostra produzione e non originali. Pesi e misure sono puramente indicativi e possono essere modificati senza preavviso. La riproduzione anche parziale del presente catalogo è vietata. All articles are of our production and not original. Weights and measures are approximate and may change without notice. Reproduction of this catalog is prohibited. Tous les articles sont fabriqués par nous-mêmes et non d'origine. Les poids et mesures sont approximatifs et peuvent changer sans préavis. Alle Artikel werden von uns selbst hergestellt und nicht original. Masse und Gewichte sind Richtwerte und können ohne Vorankündigung geändert werden.

COLTELLI PER TRINCIA

BLADES FOR CHOPPERS - COUTEAUX POUR BROyeurs
MESSER - CUCHILLOS PARA TRITURADORAS

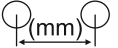

Codice Ref. Re. Codigo	Marca e descrizione modello Brand name and model description Constructeur et description du modèle Marke und Modell Beschreibung Marca y modelo de descripción	Quote/ Dimensions Abmessungen Dimensiones (mm) 	Piatto Plate Platte Plaque 	Curvatura Curvature Corbure Krummung 	Foro Hole Trou Locher Hoyos Ø (mm)	Interasse Cent. Distance Achsenabstand Distancia entre ejes 	Peso Weight Gewicht Poids 
---------------------------------	--	---	---	--	---	---	---

SICMA

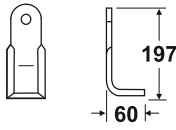
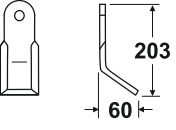
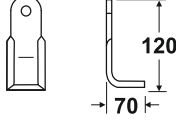
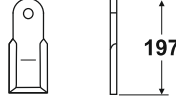
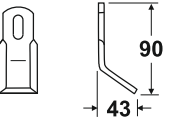
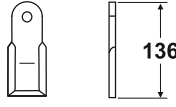
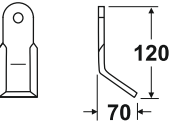
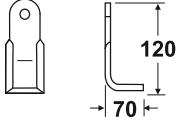



TSIC01	COLTELLO		60 X 8	SQ	25.5	-	780
TSIC02	COLTELLO Y TRP		60 X 8	Y	25.5	-	720
TSIC03	COLTELLO TIPO CORTO		60 X 8	SQ	25.5	-	600
TSIC04	COLTELLO DIRITTO		60 X 8	D	25.5	-	670
TSIC05	COLTELLO Y ASOLA FM - FR Cod Orig: 900240060		40 X 6	Y	30 X 14	-	170
TSIC06	COLTELLO DIRITTO		40 X 6	D	16.5	-	230
TSIC07	COLTELLO Y LEGGERO		50 X 10	Y	16.5	-	500
TSIC08	COLTELLO LEGGERO		50 X 10	SQ	16.5	-	560

Tutti gli articoli sono di nostra produzione e non originali. Pesì e misure sono puramente indicativi e possono essere modificati senza preavviso. La riproduzione anche parziale del presente catalogo è vietata. All articles are of our production and not original. Weights and measures are approximate and may change without notice. Reproduction of this catalog is prohibited. Tous les articles sont fabriqués par nous-mêmes et non d'origine. Les poids et mesures sont approximatifs et peuvent changer sans préavis. Alle artikel werden von uns selbst hergestellt und nicht original. Masse und gewichte sind richtwerte und kan ohne vorank undigung gendert werden.

COLTELLI PER TRINCIA

BLADES FOR CHOPPERS - COUTEAUX POUR BROyeurs
MESSER - CUCHILLOS PARA TRITURADORAS

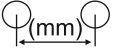
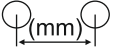

Codice Ref. Re. Codigo	Marca e descrizione modello Brand name and model description Constructeur et description du modèle Marke und Modell Beschreibung Marca y modelo de descripción	Quote/ Dimensions Abmessungen Dimensiones (mm) 	Piatto Plate Platte Plaque 	Curvatura Curvature Corbure Krummung 	Foro Hole Trou Locher Hoyos Ø (mm) 	Interasse Cent. Distance Achsenabstand Distancia entre ejes 	Peso Weight Gewicht Poids 
------------------------	--	---	---	--	--	---	---

SICMA

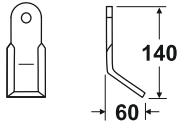
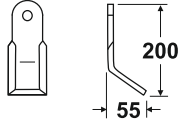
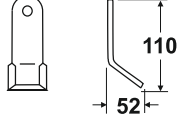
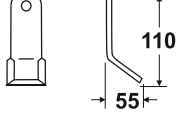
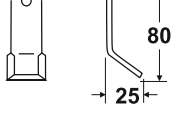
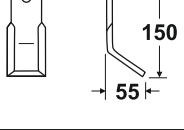
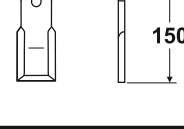
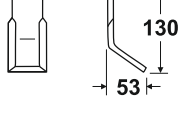
TSIC09	COLTELLO Y TRX - TR Cod Orig: 5816618		60 X 8	Y	25.5	-	520
TSIC10	COLTELLO Y TRP PESANTE Cod Orig: 5816918		60 X 10	Y	25.5	-	930
TSIC11	COLTELLO Y TLX		40 X 8	Y	16.5	-	380
TSIC12	COLTELLO Y TS - TSP - TSN - TZF TUF - SL - FB Cod Orig: 5816274		40 X 10	Y	20.5	-	420
TSIC13	COLTELLO Y TA Cod Orig: 5815275		35 X 5	Y	14.5	-	105
TSIC14	COLTELLO Y TRG		60 X 10	Y	25.5	-	650
TSIC15	COLTELLO DIRITTO TRG		60 X 10	D	25.5	-	610
TSIC16	COLTELLO Y TRP		45 X 8	Y	16.5	-	720

Tutti gli articoli sono di nostra produzione e non originali. Pesì e misure sono puramente indicativi e possono essere modificati senza preavviso. La riproduzione anche parziale del presente catalogo è vietata. All articles are of our production and not original. Weights and measures are approximate and may change without notice. Reproduction of this catalog is prohibited. Tous les articles sont fabriqués par nous-même et non d'origine. Les poids et mesurent approximatifs et peuvent changer sans preavis. Alle artikel werden von uns selbst hergestellt und nicht original. Masse und gewichte sind richtwerte und kan ohne vorank undigung gendert werden.

COLTELLI PER TRINCIA

BLADES FOR CHOPPERS - COUTEAUX POUR BROyeurs
MESSER - CUCHILLOS PARA TRITURADORAS



Codice Ref. Re. Codigo	Marca e descrizione modello Brand name and model description Constructeur et description du modèle Marke und Modell Beschreibung Marca y modelo de descripción	Quote/ Dimensions Abmessungen Dimensiones (mm) 	Piatto Plate Platte Plaque 	Curvatura Curvature Corbure Krummung 	Foro Hole Trou Locher Hoyos Ø (mm)	Interasse Cent. Distance Achsenabstand Distancia entre ejes 	Peso Weight Gewicht Poids
------------------------	--	--	---	---	---	--	--

SICMA

TSIC17	COLTELLO Y		40 X 5	Y	12.5	-	160
TSIC18	DENTE GIRATO		50 X 8	D	25.5	-	510

SMA

TSMA01	COLTELLO Y ASOLA BG 59 TIPO CORTO		40 X 5	Y	30 X 15	-	140
TSMA02	COLTELLO Y ASOLA T 59		40 X 8	Y	26 X 14	-	180
TSMA03	COLTELLO Y ASOLA BG 59		40 X 5	Y	27 X 14	-	150
TSMA04	COLTELLO Y LAU		40 X 5	Y	14.5	-	200

SOVEMA





TSOV01	COLTELLO Y MEC - JUMBO - FC Cod Orig: 900238065		60 X 8	Y	25.5	-	720
--------	---	--	--------	---	------	---	-----

Tutti gli articoli sono di nostra produzione e non originali. Pesì e misure sono puramente indicativi e possono essere modificati senza preavviso. La riproduzione anche parziale del presente catalogo è vietata. All articles are of our production and not original. Weights and measures are approximate and may change without notice. Reproduction of this catalog is prohibited. Tous les articles sont fabriqués par nous-mêmes et non d'origine. Les poids et mesures sont approximatifs et peuvent changer sans préavis. Alle Artikel werden von uns selbst hergestellt und nicht original. Masse und Gewichte sind Richtwerte und können ohne Vorankündigung geändert werden.

COLTELLI PER TRINCIA

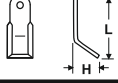
BLADES FOR CHOPPERS - COUTEAUX POUR BROyeurs
MESSER - CUCHILLOS PARA TRITURADORAS

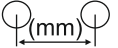
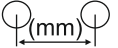

Codice Ref. Re. Codigo	Marca e descrizione modello Brand name and model description Constructeur et description du modèle Marke und Modell Beschreibung Marca y modelo de descripción	Quote/ Dimensions Abmessungen Dimensiones (mm) 	Piatto Plate Platte Plaque 	Curvatura Curvature Corbure Krummung 	Foro Hole Trou Locher Hoyos Ø (mm) 	Interasse Cent. Distance Achsenabstand Distancia entre ejes 	Peso Weight Gewicht Poids 
------------------------	--	---	--	--	---	---	--

SOVEMA

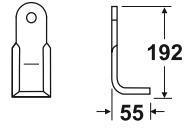
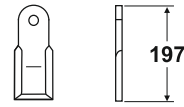
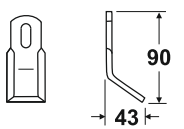
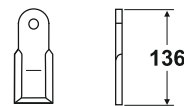
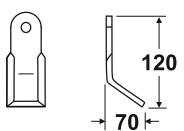
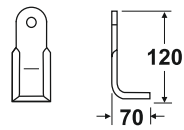
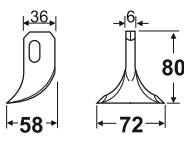
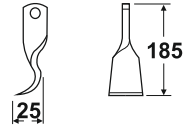
TSOV02	COLTELLO		60 X 8	SQ	25.5	-	820
TSOV03	COLTELLO DIRITTO		60 X 8	D	25.5	-	670
TSOV04	COLTELLO Y ASOLA FL - FM - VF		40 X 6	Y	30 X 14	-	170
TSOV05	COLTELLO DIRITTO		40 X 6	D	16.5	-	230
TSOV06	COLTELLO Y LEGGERO		50 X 12	Y	16.5	-	500
TSOV07	COLTELLO LEGGERO		50 X 10	SQ	16.5	-	560
TSOV08	SPATOLA ASOLA		70 X 3	-	25 X 14	-	160
TSOV09	COLTELLO GIRATO		50 X 8	D	25,5	-	480

Tutti gli articoli sono di nostra produzione e non originali. Pesi e misure sono puramente indicativi e possono essere modificati senza preavviso. La riproduzione anche parziale del presente catalogo è vietata. All articles are of our production and not original. Weights and measures are approximate and may change without notice. Reproduction of this catalog is prohibited. Tous les articles sont fabriqués par nous-même mes et non d'origine. Les poids et mesurent approximatifs et peuvent changer sans preavis. Alle artikel werden von uns selbst hergestellt und nicht original. Masse und gewichte sind richtwerte und kan ohne vorank undigung gendert werden.

COLTELLI PER TRINCIA

BLADES FOR CHOPPERS - COUTEAUX POUR BROyeurs
MESSER - CUCHILLOS PARA TRITURADORAS



Codice Ref. Re. Codigo	Marca e descrizione modello Brand name and model description Constructeur et description du modèle Marke und Modell Beschreibung Marca y modelo de descripción	Quote/ Dimensions Abmessungen Dimensiones (mm) 	Piatto Plate Platte Plaque 	Curvatura Curvature Corbure Krummung 	Foro Hole Trou Locher Hoyos Ø (mm)	Interasse Cent. Distance Achsenabstand Distancia entre ejes 	Peso Weight Gewicht Poids
------------------------	--	--	---	---	---	--	--

SPEDO

TSPD01	COLTELLO Y Cod Orig: M401ZA3505		35 X 5	Y	14.5	-	105
TSPD02	COLTELLO Y Cod Orig: A32001600		40 X 10	Y	20.5	-	400

TAARUP





TTAA01	COLTELLO DIRITTO Cod Orig: 49501300		65 X 7	D	29	-	700
TTAA02	COLTELLO Y Cod Orig: 50507000		65 X 7	Y	29	-	700
TTAA03	PALETTA Cod Orig: 40882300		75 X 7	Y	14.5	-	600
TTAA04	PALETTA		75 X 7	Y	14.5	-	400
TTAA05	LAMA SAGOMATA DESTRA E SINISTRA		75 X 7	C	14.5	-	450

Tutti gli articoli sono di nostra produzione e non originali. Pesi e misure sono puramente indicativi e possono essere modificati senza preavviso. La riproduzione anche parziale del presente catalogo è vietata. All articles are of our production and not original. Weights and measures are approximate and may change without notice. Reproduction of this catalog is prohibited. Tous les articles sont fabriqués par nous-mêmes et non d'origine. Les poids et mesures sont approximatifs et peuvent changer sans préavis. Alle Artikel werden von uns selbst hergestellt und nicht original. Masse und Gewichte sind Richtwerte und können ohne Vorankündigung geändert werden.

COLTELLI PER TRINCIA

BLADES FOR CHOPPERS - COUTEAUX POUR BROyeurs
MESSER - CUCHILLOS PARA TRITURADORAS

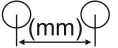
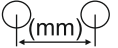

Codice Ref. Re. Codigo	Marca e descrizione modello Brand name and model description Constructeur et description du modèle Marke und Modell Beschreibung Marca y modelo de descripción	Quote/ Dimensions Abmessungen Dimensiones (mm) 	Piatto Plate Platte Plaque 	Curvatura Curvature Corbure Krummung 	Foro Hole Trou Locher Hoyos Ø (mm) 	Interasse Cent. Distance Achsenabstand Distancia entre ejes 	Peso Weight Gewicht Poids 
------------------------	--	---	---	--	--	---	---

TAARUP

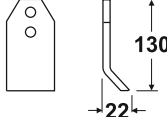
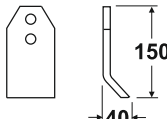
TAA06	PALETTA Cod Orig: 49305000		75 X 7	Y	13.5	55	550
TAA07	PALETTA Cod Orig: 49304000		75 X 7	Y	13.5	55	500

TERRANOVA

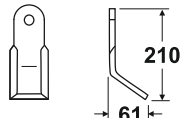
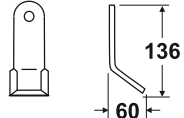
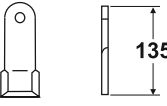
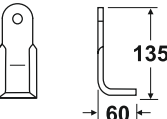
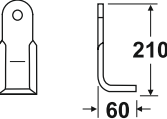
TTR01	COLTELLO Y PESANTE		60 X 8	Y	25.5	-	740
TTR02	COLTELLO Y LEGGERO		45 X 5	Y	16.5	-	400
TTR03	COLTELLO DIRITTO		45 X 8	D	16.5	-	400
TTR04	COLTELLO LEGGERO		45 X 8	SQ	16.5	-	490
TTR05	COLTELLO PESANTE		60 X 8	SQ	25.5	-	820

Tutti gli articoli sono di nostra produzione e non originali. Pesi e misure sono puramente indicativi e possono essere modificati senza preavviso. La riproduzione anche parziale del presente catalogo è vietata. All articles are of our production and not original. Weights and measures are approximate and may change without notice. Reproduction of this catalog is prohibited. Tous les articles sont fabriqués par nous-mêmes et non d'origine. Les poids et mesurages sont approximatifs et peuvent changer sans préavis. Alle Artikel werden von uns selbst hergestellt und nicht original. Masse und Gewichte sind Richtwerte und können ohne Vorankündigung geändert werden.

COLTELLI PER TRINCIA

BLADES FOR CHOPPERS - COUTEAUX POUR BROyeurs
MESSER - CUCHILLOS PARA TRITURADORAS



Codice Ref. Re. Codigo	Marca e descrizione modello Brand name and model description Constructeur et description du modèle Marke und Modell Beschreibung Marca y modelo de descripción	Quote/ Dimensions Abmessungen Dimensiones (mm) 	Piatto Plate Platte Plaque 	Curvatura Curvature Corbure Krummung 	Foro Hole Trou Locher Hoyos Ø (mm)	Interasse Cent. Distance Achsenabstand Distancia entre ejes 	Peso Weight Gewicht Poids
---------------------------------	--	--	---	---	---	--	--

TIERRE

TTIE01	COLTELLO DIRITTO		60 X 7	D	25.5	-	800
TTIE02	COLTELLO Y		60 X 7	Y	25.5	-	725
TTIE03	COLTELLO Y PESANTE		60 X 10	Y	25.5	-	1050
TTIE04	COLTELLO Y PONY		40 X 10	Y	16.5	-	450
TTIE05	COLTELLO DIRITTO Cod Orig: 7000002671		60 X 10	-	14.5	-	180
TTIE06	COLTELLO DIRITTO SCARIFICATORE		40 X 4	D	10.5	-	145
TTIE07	SPATOLA		40 X 4	-	10.5	-	150
TTIE08	COLTELLO ROTORE DINO		60 X 10	-	10.5	60	500

Tutti gli articoli sono di nostra produzione e non originali. Pesi e misure sono puramente indicativi e possono essere modificati senza preavviso. La riproduzione anche parziale del presente catalogo è vietata. All articles are of our production and not original. Weights and measures are approximate and may change without notice. Reproduction of this catalog is prohibited. Tous les articles sont fabriqués par nous-mêmes et non d'origine. Les poids et mesures sont approximatifs et peuvent changer sans préavis. Alle Artikel werden von uns selbst hergestellt und nicht original. Masse und Gewichte sind Richtwerte und können ohne Vorankündigung geändert werden.

COLTELLI PER TRINCIA

BLADES FOR CHOPPERS - COUTEAUX POUR BROyeurs
MESSER - CUCHILLOS PARA TRITURADORAS



Codice Ref. Re. Codigo	Marca e descrizione modello Brand name and model description Constructeur et description du modèle Marke und Modell Beschreibung Marca y modelo de descripción	Quote/ Dimensions Abmessungen Dimensiones (mm) 	Piatto Plate Platte Plaque 	Curvatura Curvature Corbure Krummung 	Foro Hole Trou Locher Hoyos Ø (mm) 	Interasse Cent. Distance Achsenabstand Distancia entre ejes 	Peso Weight Gewicht Poids
------------------------	--	--	---	---	---	--	--

TIERRE

TTIE09	COLTELLO		50 X 10	-	10.5	-	235
TTIE10	COLTELLO Y		40 X 10	Y	16.5	-	480
TTIE11	COLTELLO Y		60 X 10	Y	25.5	-	670
TTIE12	COLTELLO DIRITTO		60 X 10	D	25.5	-	580
TTIE13	COLTELLO Y		35 X 5	Y	10.5	-	130
TTIE14	COLTELLO Y RINFORZATO		60 X 8	Y	25.5	-	820

TORTELLA

TTOR01	COLTELLO Y TP 13 - TP 15 Cod Orig: 2987026		60 X 10	Y	25.5	-	1000
TTOR02	COLTELLO Y TP 15 Cod Orig: 2987020		60 X 10	Y	25.5	-	880

Tutti gli articoli sono di nostra produzione e non originali. Pesì e misure sono puramente indicativi e possono essere modificati senza preavviso. La riproduzione anche parziale del presente catalogo è vietata. All articles are of our production and not original. Weights and measures are approximate and may change without notice. Reproduction of this catalog is prohibited. Tous les articles sont fabriqués par nous-mêmes et non d'origine. Les poids et mesurés sont approximatifs et peuvent changer sans préavis. Alle artikel werden von uns selbst hergestellt und nicht original. Masse und gewichte sind richtwerte und kan ohne vorank undigung gendert werden.

COLTELLI PER TRINCIA

BLADES FOR CHOPPERS - COUTEAUX POUR BROyeurs
MESSER - CUCHILLOS PARA TRITURADORAS



Codice Ref. Re. Codigo	Marca e descrizione modello Brand name and model description Constructeur et description du modèle Marke und Modell Beschreibung Marca y modelo de descripción	Quote/ Dimensions Abmessungen Dimensiones (mm) 	Piatto Plate Platte Plaque 	Curvatura Curvature Corbure Krummung 	Foro Hole Trou Locher Hoyos Ø (mm)	Interasse Cent. Distance Achsenabstand Distancia entre ejes 	Peso Weight Gewicht Poids
------------------------	--	--	---	---	---	--	--

TORTELLA





TTOR03	COLTELLO Y		60 X 8	Y	25.5	-	510
TTOR04	COLTELLO Y TR 6 - TR 8 - TR 10 TIPO CORTO Cod Orig: 2987010		60 X 8	Y	22.5	-	520
TTOR05	COLTELLO DIRITTO TR 15		60 X 8	D	25.5	-	730
TTOR06	COLTELLO Y TR 8 - TR 9 - TR 10 Cod Orig: 2987011		60 X 8	Y	22.5	-	540
TTOR07	COLTELLO TR		55 X 15	SQ	22.5	-	1100
TTOR08	COLTELLO		60 X 10	SQ	22.5	-	800
TTOR09	COLTELLO DIRITTO		60 X 10	D	22.5	-	800
TTOR10	COLTELLO DIRITTO TP15		60 X 8	D	25.5	-	680

Tutti gli articoli sono di nostra produzione e non originali. Pesi e misure sono puramente indicativi e possono essere modificati senza preavviso. La riproduzione anche parziale del presente catalogo è vietata. All articles are of our production and not original. Weights and measures are approximate and may change without notice. Reproduction of this catalog is prohibited. Tous les articles sont fabriqués par nous-même et non d'origine. Les poids et mesurés sont approximatifs et peuvent changer sans préavis. Alle artikel werden von uns selbst hergestellt und nicht original. Masse und gewichte sind richtwerte und kan ohne vorank undigung gendert werden.

COLTELLI PER TRINCIA

BLADES FOR CHOPPERS - COUTEAUX POUR BROyeurs
MESSER - CUCHILLOS PARA TRITURADORAS

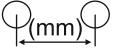

Codice Ref. Re. Codigo	Marca e descrizione modello Brand name and model description Constructeur et description du modèle Marke und Modell Beschreibung Marca y modelo de descripción	Quote/ Dimensions Abmessungen Dimensiones (mm) 	Piatto Plate Platte Plaque 	Curvatura Curvature Corbure Krummung 	Foro Hole Trou Locher Hoyos Ø (mm) 	Interasse Cent. Distance Achsenabstand Distancia entre ejes 	Peso Weight Gewicht Poids 
---------------------------------	--	---	---	--	--	---	---

UBALDI

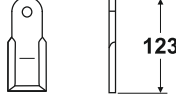
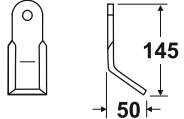
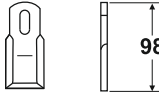
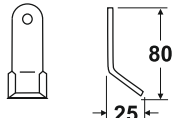
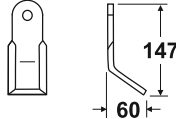
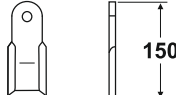
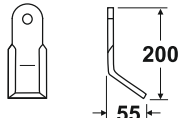
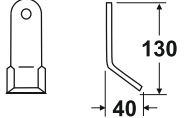



TUBL01	COLTELLO DIRITTO		50 X 10	D	20.5	-	480
TUBL02	COLTELLO Y		50 X 10	Y	20.5	-	600
TUBL03	COLTELLO DIRITTO ASOLA		40 X 5	D	30 X 14	-	150
TUBL04	COLTELLO Y		35 X 5	Y	14.5	-	120
TUBL05	COLTELLO Y		60 X 8	Y	25.5	-	520
TUBL06	COLTELLO DIRITTO		60 X 8	D	25.5	-	450
TUBL07	COLTELLO Y		60 X 10	Y	25.5	-	930
TUBL08	COLTELLO Y		40 X 8	Y	16.5	-	380

Tutti gli articoli sono di nostra produzione e non originali. Pesì e misure sono puramente indicativi e possono essere modificati senza preavviso. La riproduzione anche parziale del presente catalogo è vietata. All articles are of our production and not original. Weights and measures are approximate and may change without notice. Reproduction of this catalog is prohibited. Tous les articles sont fabriqués par nous-mêmes et non d'origine. Les poids et mesurés sont approximatifs et peuvent changer sans préavis. Alle artikel werden von uns selbst hergestellt und nicht original. Masse und gewichte sind richtwerte und kan ohne vorank undigung gendert werden.

COLTELLI PER TRINCIA

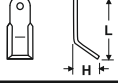
BLADES FOR CHOPPERS - COUTEAUX POUR BROyeurs
MESSER - CUCHILLOS PARA TRITURADORAS



Codice Ref. Re. Codigo	Marca e descrizione modello Brand name and model description Constructeur et description du modèle Marke und Modell Beschreibung Marca y modelo de descripción	Quote/ Dimensions Abmessungen Dimensiones (mm) 	Piatto Plate Platte Plaque 	Curvatura Curvature Corbure Krummung 	Foro Hole Trou Locher Hoyos Ø (mm)	Interasse Cent. Distance Achsenabstand Distancia entre ejes 	Peso Weight Gewicht Poids 
------------------------	--	---	---	--	---	---	---

UBALDI

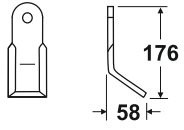
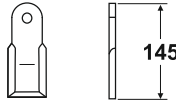
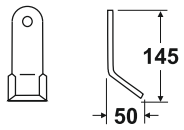
TUBL09	COLTELLO Y LEGGERO		60 X 10	Y	25.5	-	850
TUBL10	COLTELLO DIRITTO LEGGERO		50 X 8	D	20.5	-	430
TUBL11	COLTELLO Y LEGGERO		50 X 8	Y	20.5	-	450

UGELOSE

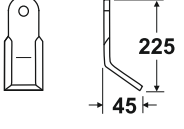
TUGE01	COLTELLO Y		65 X 7	Y	28.5	-	800

VALENTINI

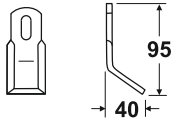



TVLN01	COLTELLO Y ASOLA		40 X 8	Y	35 X 17	-	200
--------	---------------------	---	--------	---	---------	---	-----

Tutti gli articoli sono di nostra produzione e non originali. Pesi e misure sono puramente indicativi e possono essere modificati senza preavviso. La riproduzione anche parziale del presente catalogo è vietata. All articles are of our production and not original. Weights and measures are approximate and may change without notice. Reproduction of this catalog is prohibited. Tous les articles sont fabriqués par nous-mêmes et non d'origine. Les poids et mesurent approximatifs et peuvent changer sans préavis. Alle artikel werden von uns selbst hergestellt und nicht original. Masse und gewichte sind richtwerte und kan ohne vorank undigung gendert werden.

COLTELLI PER TRINCIA

BLADES FOR CHOPPERS - COUTEAUX POUR BROyeurs
MESSER - CUCHILLOS PARA TRITURADORAS

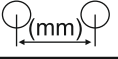

Codice Ref. Re. Codigo	Marca e descrizione modello Brand name and model description Constructeur et description du modèle Marke und Modell Beschreibung Marca y modelo de descripción	Quote/ Dimensions Abmessungen Dimensiones (mm) 	Piatto Plate Platte Plaque 	Curvatura Curvature Corbure Krummung 	Foro Hole Trou Locher Hoyos Ø (mm)	Interasse Cent. Distance Achsenabstand Distancia entre ejes 	Peso Weight Gewicht Poids 
------------------------	--	---	---	--	---	---	---

VIGOLO

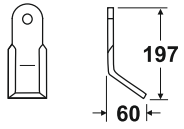
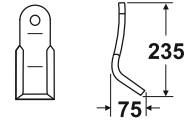
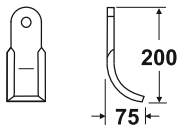
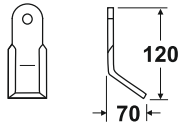
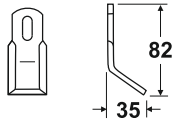
TVIG01	COLTELLO Y		60 X 8	Y	25.5	-	720
TVIG02	COLTELLO Y		60 X 8	Y	25.5	-	960
TVIG03	COLTELLO CURVO TST Cod Orig: 11019		60 X 8	C	25.5	-	800
TVIG04	COLTELLO Y TSA - L Cod Orig: 931040002		60 X 8	Y	25.5	-	460
TVIG05	COLTELLO Y ASOLA		40 X 5	Y	27 X 13	-	120

VOTEX

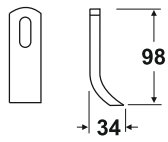



TVOT01	COLTELLO SPATOLA ASOLA		35 X 10	Y	30 X 14	-	230

Tutti gli articoli sono di nostra produzione e non originali. Pesì e misure sono puramente indicativi e possono essere modificati senza preavviso. La riproduzione anche parziale del presente catalogo è vietata. All articles are of our production and not original. Weights and measures are approximate and may change without notice. Reproduction of this catalog is prohibited. Tous les articles sont fabriqués par nous-mêmes et non d'origine. Les poids et mesures sont approximatifs et peuvent changer sans préavis. Alle artikel werden von uns selbst hergestellt und nicht original. Masse und gewichte sind richtwerte und kan ohne vorank undigung gendert werden.

COLTELLI PER TRINCIA

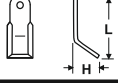
BLADES FOR CHOPPERS - COUTEAUX POUR BROyeurs
MESSER - CUCHILLOS PARA TRITURADORAS

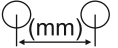

Codice Ref. Re. Codigo	Marca e descrizione modello Brand name and model description Constructeur et description du modèle Marke und Modell Beschreibung Marca y modelo de descripción	Quote/ Dimensions Abmessungen Dimensiones (mm) 	Piatto Plate Platte Plaque 	Curvatura Curvature Corbure Krummung 	Foro Hole Trou Locher Hoyos Ø (mm)	Interasse Cent. Distance Achsenabstand Distancia entre ejes 	Peso Weight Gewicht Poids 
---------------------------------	--	---	---	--	---	---	---

ZAMPINI

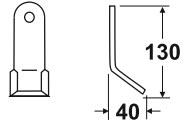
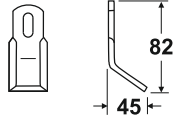
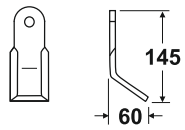
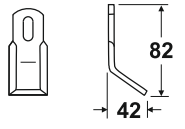
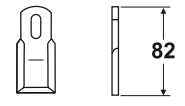
TZAM01	COLTELLO Y		40 X 8	Y	16.5	-	380
TZAM02	COLTELLO Y ASOLA		40 X 8	Y	30 X 14	-	210
TZAM03	COLTELLO Y		60 X 8	Y	25.5	-	520
TZAM04	COLTELLO Y ASOLA		40 X 5	Y	30 X 14	-	140
TZAM05	COLTELLO DIRITTO ASOLA		40 X 5	D	30 X 14	-	120

ZANON

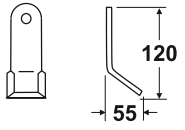
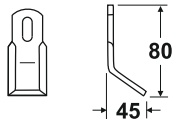



TZAN01	COLTELLO Y Cod Orig: 5350040		40 X 8	Y	20.5	-	330
TZAN02	COLTELLO Y ASOLA		40 X 8	Y	30 X 14	-	250

Tutti gli articoli sono di nostra produzione e non originali. Pesì e misure sono puramente indicativi e possono essere modificati senza preavviso. La riproduzione anche parziale del presente catalogo è vietata. All articles are of our production and not original. Weights and measures are approximate and may change without notice. Reproduction of this catalog is prohibited. Tous les articles sont fabriqués par nous-mêmes et non d'origine. Les poids et mesurés sont approximatifs et peuvent changer sans préavis. Alle artikel werden von uns selbst hergestellt und nicht original. Masse und gewichte sind richtwerte und kan ohne vorank undigung gendert werden.

COLTELLI PER TRINCIA

BLADES FOR CHOPPERS - COUTEAUX POUR BROyeurs
MESSER - CUCHILLOS PARA TRITURADORAS

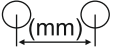
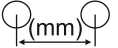

Codice Ref. Re. Codigo	Marca e descrizione modello Brand name and model description Constructeur et description du modèle Marke und Modell Beschreibung Marca y modelo de descripción	Quote/ Dimensions Abmessungen Dimensiones (mm) 	Piatto Plate Platte Plaque 	Curvatura Curvature Corbure Krummung 	Foro Hole Trou Locher Hoyos Ø (mm) 	Interasse Cent. Distance Achsenabstand Distancia entre ejes 	Peso Weight Gewicht Poids 
------------------------	--	---	---	--	--	---	---

ZANON

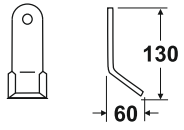
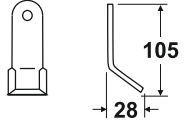
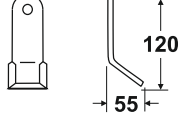
TZAN03	COLTELLO Y		40 X 8	Y	16.5	-	300
TZAN04	COLTELLO Y		30 X 4	Y	10.5	-	90
TZAN05	COLTELLO Y		40 X 8	Y	14.5	-	340

ZAPPATOR

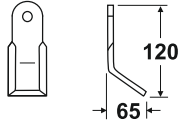
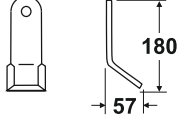
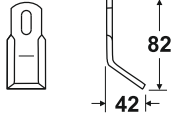
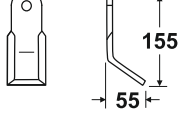



TZAP01	COLTELLO Y TIPOCORTO Cod Orig: 56000421		60 X 10	Y	20.5	-	660
TZAP02	COLTELLO Y TL LEGGERO		50 X 10	Y	20.5	-	550
TZAP03	COLTELLO Y ASOLA		40 X 5	Y	30 X 14	-	140
TZAP04	COLTELLO Y Cod Orig: 50000421		60 X 10	Y	20.5	-	660

Tutti gli articoli sono di nostra produzione e non originali. Pesi e misure sono puramente indicativi e possono essere modificati senza preavviso. La riproduzione anche parziale del presente catalogo è vietata. All articles are of our production and not original. Weights and measures are approximate and may change without notice. Reproduction of this catalog is prohibited. Tous les articles sont fabriqués par nous-même mes et non d'origine. Les poids et mesurssont approximatifs et peuvent changer sans preavis. Alle artikel werden von uns selbst hergestellt und nicht original. Masse und gewichte sind richtwerte und kan ohne vorank undigung gendert werden.

COLTELLI PER TRINCIA

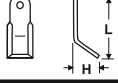
BLADES FOR CHOPPERS - COUTEAUX POUR BROyeurs
MESSER - CUCHILLOS PARA TRITURADORAS

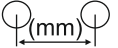
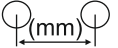

Codice Ref. Re. Codigo	Marca e descrizione modello Brand name and model description Constructeur et description du modèle Marke und Modell Beschreibung Marca y modelo de descripción	Quote/ Dimensions Abmessungen Dimensiones (mm) 	Piatto Plate Platte Plaque 	Curvatura Curvature Corbure Krummung 	Foro Hole Trou Locher Hoyos Ø (mm) 	Interasse Cent. Distance Achsenabstand Distancia entre ejes 	Peso Weight Gewicht Poids 
---------------------------------	--	---	---	--	--	---	---

ZAPPATOR

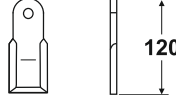
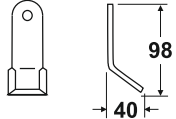
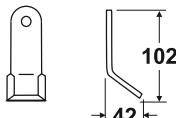
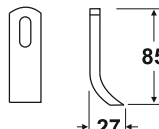
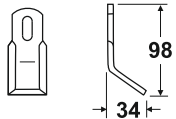
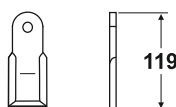
TZAP05	COLTELLO DIRITTO		60 X 10	D	20.5	-	500
TZAP06	COLTELLO Y		35 X 4	Y	10.5	-	110
TZAP07	COLTELLO Y		40 X 6	Y	14.5	-	220
TZAP08	COLTELLO SPATOLA ASOLA Cod Orig: 61000422		50 X 8	C	35 X 14	-	250
TZAP09	COLTELLO Y Cod Orig: 62000425		35 X 10	Y	33 X 13	-	220
TZAP10	COLTELLO DIRITTO		35 X 4	D	10.5	-	130

Tutti gli articoli sono di nostra produzione e non originali. Pesi e misure sono puramente indicativi e possono essere modificati senza preavviso. La riproduzione anche parziale del presente catalogo è vietata. All articles are of our production and not original. Weights and measures are approximate and may change without notice. Reproduction of this catalog is prohibited. Tous les articles sont fabriqués par nous-même et non d'origine. Les poids et mesurés sont approximatifs et peuvent changer sans préavis. Alle artikel werden von uns selbst hergestellt und nicht original. Masse und gewichte sind richtwerte und kan ohne vorank undigung gendert werden.