

ZAPPETTE

BLADES - COUTEAUX - MESSER - CUCHILLOS

Codice Code Ref. Re. Codigo	Marca e descrizione modello Brand name and model description Constructeur et description du modèle Marke und Modell Beschreibung Marca y modelo de descripción	Quote Dimensions Abmessungen Dimensiones 	Piatto Plate Platte Plaque 	Curvatura Curvature Corbure Krummung 	Foro Hole Trou Locher Hoyos Ø (mm)	Interasse Cent. Distance Achsenabstand Distancia entre ejes 	Peso Weight Gewicht Poids
---	--	---	---	---	---	--	--

ADRIATICA

ZADR01	ALFA MINNY		30 X 5	C	8.5	50	160
ZADR03	MINIMEC		30 X 6	C	8.5	50	260
ZADR05	MINIMEC TIPO NUOVO		30 X 6	SQ	8.5	70	280
ZADR06	ACF 400 MINIMEC		35 X 6	C Elicoidale	8.5	70	400
ZADR07	PANTERA HP 8 - 10		40 X 5	C	8.5	70	340
ZADR08	SUPERMEC		40 X 6	C	10.5	46	350
ZADR09	TIGRE HP 10 - 14		40 X 6	C	10.5	85	480
ZADR10	TIGRE		40 X 6	SQ	10.5	85	480

Tutti gli articoli sono di nostra produzione e non originali. Pesì e misure sono puramente indicativi e possono essere modificati senza preavviso. La riproduzione anche parziale del presente catalogo è vietata. All articles are of our production and not original. Weights and measures are approximate and may change without notice. Reproduction of this catalog is prohibited. Tous les articles sont fabriqués par nous-mêmes et non d'origine. Les poids et mesures sont approximatifs et peuvent changer sans préavis. Alle Artikel werden von uns selbst hergestellt und nicht original. Masse und Gewichte sind Richtwerte und können ohne Vorankündigung geändert werden.

Codice Code Ref. Re. Codigo	Marca e descrizione modello Brand name and model description Constructeur et description du modèle Marke und Modell Beschreibung Marca y modelo de descripción	Quote Dimensions Abmessungen Dimensiones 	Piatto Plate Platte Plaque 	Curvatura Curvature Corbure Krummung 	Foro Hole Trou Locher Hoyos Ø (mm) 	Interasse Cent. Distance Achsenabstand Distancia entre ejes 	Peso Weight Gewicht Poids 
---	--	--	---	--	--	---	---

ADRIATICA

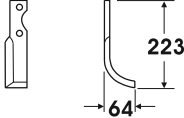
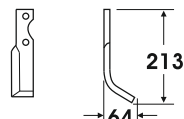
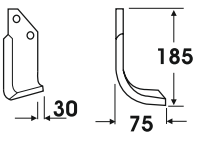
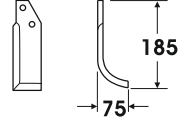
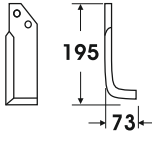
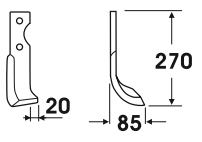
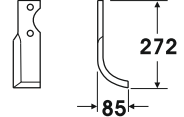
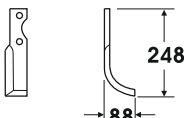
ZADR11	TIGROTTO OMEGA		40 X 6	C	10.5	70	440
ZADR12	TIGROTTO OMEGA		40 X 6	SSQ	10.5	70	440
ZADR13	INTERMEC DELTA		40 X 6	C Elicoidale	10.5	46	420
ZADR14	SUPERMEC R HP 15 - 18		50 X 6	C	10.5	46	470
ZADR15	SUPERMEC R		50 X 6	SQ	10.5	46	470
ZADR16	MASTERMEC S2		60 X 6	C Elicoidale	12.5	90	780
ZADR17	MASTERMEC S2		60 X 6	SQ	12.5	90	840
ZADR18	TIGRE MAGGIORATA		50 X 6	C Elicoidale	10.5	85	750

Codice Code Ref. Re. Codigo	Marca e descrizione modello Brand name and model description Constructeur et description du modèle Marke und Modell Beschreibung Marca y modelo de descripción	Quote Dimensions Abmessungen Dimensiones 	Piatto Plate Platte Plaque 	Curvatura Curvature Corbure Krummung 	Foro Hole Trou Locher Hoyos Ø (mm)	Interasse Cent. Distance Achsenabstand Distancia entre ejes 	Peso Weight Gewicht Poids
---	--	---	---	---	---	--	--

ADRIATICA

ZADR19	TIPO REGGIO		60 X 6	SQ	10.5	46	680
--------	-------------	--	--------	----	------	----	-----

AGRATOR

ZATRO1	11 - L VF/AL		75 X 6	SQ	11.5	57	840
ZATRO2	01 - SL AR		80 X 7	SQ Elicoidale	13.5	57	1150
ZATRO3	04 - CL AV		60 X 6	C Elicoidale	11.5	35	670
ZATRO4	INTERRASASSI		85 X 9	-	13.5	57	1400

AGRIA

ZAGR01	2100 Cod Orig: 25497-98		30 X 4	SQ Elicoidale	8.5	70	190
ZAGR02	2100 CORTA Cod Orig: 17548-49		30 X 4	SQ Elicoidale	8.5	70	180

Codice Code Ref. Re. Codigo	Marca e descrizione modello Brand name and model description Constructeur et description du modèle Marke und Modell Beschreibung Marca y modelo de descripción	Quote Dimensions Abmessungen Dimensiones 	Piatto Plate Platte Plaque 	Curvatura Curvature Corbure Krummung 	Foro Hole Trou Locher Hoyos Ø (mm)	Interasse Cent. Distance Achsenabstand Distancia entre ejes 	Peso Weight Gewicht Poids
---	--	---	---	---	---	--	--

AGRIA

ZAGR03	2100 - 4000 - 6000		30 X 4	SQ Elicoidale	8.5	70	200
ZAGR04	6000 LUNGA Cod Orig: 17222-23		30 X 4	SQ Elicoidale	8.5	70	200
ZAGR05	1100 Cod Orig: 27129-30		30 X 4	SQ Elicoidale	8.5	70	160
ZAGR06	6623 - 6624 Cod Orig: 6623-24		50 X 5	SQ	10.5	38	280
ZAGR08	MOTOZAPPA 6000		30 X 4	SQ Elicoidale	8.5	70	190
ZAGR09	1 FORO Cod Orig: 1567		40 X 4	C	6.5	-	170
ZAGR10	1600 - 2400 - 2600 Cod Orig: 1667		50 X 5	SQ	8.5	38	280
ZAGR11	2500 Cod Orig: 12868-69		50 X 5	SQ	10.5	38	320

Codice Code Ref. Re. Codigo	Marca e descrizione modello Brand name and model description Constructeur et description du modèle Marke und Modell Beschreibung Marca y modelo de descripción	Quote Dimensions Abmessungen Dimensiones 	Piatto Plate Platte Plaque 	Curvatura Curvature Corbure Krummung 	Foro Hole Trou Locher Hoyos Ø (mm)	Interasse Cent. Distance Achsenabstand Distancia entre ejes 	Peso Weight Gewicht Poids
---	--	---	---	---	---	--	--

AGRIA

ZAGR12	2700 3 FORI Cod Orig: 15453-54		60 X 6	SQ Elicoidale	10.5	29	650
ZAGR13	1900 3 FORI Cod Orig: 06038-39		70 X 6	SQ Elicoidale	10.5	36	820
ZAGR14	2100 LUNGA		30 X 4	SQ Elicoidale	8.5	70	180

AGRIC

ZARC01	AM 500 - 324 - AM 325		75 X 6	SQ Elicoidale	11.5	57	850
ZARC02	10 C - 324/1 - 325/1 AFMJ		60 X 6	C Elicoidale	11.5	35	670
ZARC03	AM 500 - 324 - AM 325		75 X 6	SQ Elicoidale	12.5	57	850
ZARC04	BM 501 - 324 - BM 325		80 X 7	SQ Elicoidale	13.5	57	1130

Codice Code Ref. Re. Codigo	Marca e descrizione modello Brand name and model description Constructeur et description du modèle Marke und Modell Beschreibung Marca y modelo de descripción	Quote Dimensions Abmessungen Dimensiones 	Piatto Plate Platte Plaque 	Curvatura Curvature Corbure Krummung 	Foro Hole Trou Locher Hoyos Ø (mm)	Interasse Cent. Distance Achsenabstand Distancia entre ejes 	Peso Weight Gewicht Poids
---	--	---	---	---	---	--	--

AGRIC

ZARC05	ROOTALBOUR		60 X 12	D	14.5	46	1250
ZARC06	10 C - 324/1 - 325/1 AFMJ		60 X 6	SQ	11.5	35	690

AGRITALIA

ZAGT01	CAMPO 7		60 X 6	C	12.5	44	600
ZAGT02	ROTOCAR 3 FORI		80 X 7	C	12.5	34	1000
ZAGT03	ROTOCAR 3 FORI		80 X 7	SQ	12.5	34	1000

AGRITEC

ZART01	AT 40		70 X 7	C	14.5	45	900
--------	-------	--	--------	---	------	----	-----

Codice Code Ref. Re. Codigo	Marca e descrizione modello Brand name and model description Constructeur et description du modèle Marke und Modell Beschreibung Marca y modelo de descripción	Quote Dimensions Abmessungen Dimensiones 	Piatto Plate Platte Plaque 	Curvatura Curvature Corbure Krummung 	Foro Hole Trou Locher Hoyos Ø (mm)	Interasse Cent. Distance Achsenabstand Distancia entre ejes 	Peso Weight Gewicht Poids 
---	--	--	---	--	---	---	---

ALESSI

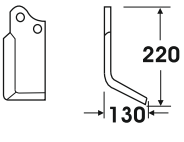
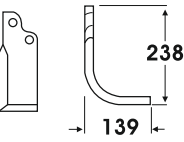
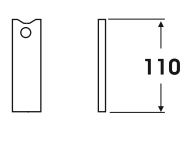
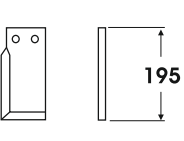
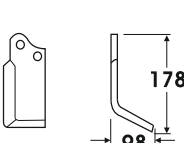
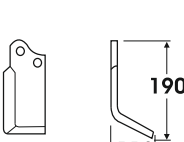
ZALS01	SUPER EXPORT TIPO NUOVO		60 X 7	C	14.5	56	850
ZALS02	EXPORT TIPO NUOVO		60 X 7	SQ	14.5	56	870
ZALS03	1 FORO		60 X 8	D	14.5	-	350
ZALS04	EXPORT TIPO NUOVO		80 X 8	D	14.5	56	1000
ZALS05	ZAPPA		70 X 7	SSQ	14.5	56	720
ZALS06	ZAPPA		80 X 8	SSQ	14.5	56	1060

Codice Code Ref. Re. Codigo	Marca e descrizione modello Brand name and model description Constructeur et description du modèle Marke und Modell Beschreibung Marca y modelo de descripción	Quote Dimensions Abmessungen Dimensiones 	Piatto Plate Platte Plaque 	Curvatura Curvature Corbure Krummung 	Foro Hole Trou Locher Hoyos Ø (mm)	Interasse Cent. Distance Achsenabstand Distancia entre ejes 	Peso Weight Gewicht Poids
---	--	---	---	---	---	--	--

ALPEGO

ZALP01	COLTELLO LD - LM - LP Cod Orig: 0543-44		60 X 10	D	14.5	130	1400
ZALP02	COLTELLO LE2 Cod Orig: D1398-9		70 X 10	D	16.5	150	1830
ZALP03	ESPLORATORE KE Cod Orig: 1590-91		80 X 8	C	14.5	57	1100
ZALP05	ROTOPIK Cod Orig: D04864-65		60 X 15	D	16.5	150	2600
ZALP06	ROTOPIK KP Cod Orig: D04866-67		50 X 12	D	14.5	130	1430
ZALP09	ZAPPA Cod Orig: D03360-61		105 X 8	C	16.5	75	1500
ZALP11	FP2 Cod Orig: D070000-01		80 X 8	C Elicoidale	14.5	56	1290
ZALP12	ZAPPA Cod Orig: HKOA00301-302		80 X 9	C Elicoidale	14.5	57	1295

Tutti gli articoli sono di nostra produzione e non originali. Pesi e misure sono puramente indicativi e possono essere modificati senza preavviso. La riproduzione anche parziale del presente catalogo è vietata. All articles are of our production and not original. Weights and measures are approximate and may change without notice. Reproduction of this catalog is prohibited. Tous les articles sont fabriqués par nous-même et non d'origine. Les poids et mesurages sont approximatifs et peuvent changer sans préavis. Alle artikel werden von uns selbst hergestellt und nicht original. Masse und gewichte sind richtwerte und kan ohne vorank undigung gendert werden.

Codice Code Ref. Re. Codigo	Marca e descrizione modello Brand name and model description Constructeur et description du modèle Marke und Modell Beschreibung Marca y modelo de descripción	Quote Dimensions Abmessungen Dimensiones 	Piatto Plate Platte Plaque 	Curvatura Curvature Corbure Krummung 	Foro Hole Trou Locher Hoyos Ø (mm)	Interasse Cent. Distance Achsenabstand Distancia entre ejes 	Peso Weight Gewicht Poids
---	--	---	---	---	---	--	--

AMAC

ZAMC01	SAGOMATORE PATATE RIPORTO ANTIUSURA		40 X 10	-	16.5	75	880
ZAMC02	SAGOMATORE PATATE		40 X 10	-	16.5	75	780

ASOLA 60-73

ZASO06	ZAPPA POLIVALENTE		35 X 6	C	8.5	60 - 73	300
ZASO07	ZAPPA POLIVALENTE		35 X 6	SQ	8.5	60 - 73	330
ZASO15	ZAPPA POLIVALENTE ASOLA		40 X 6	C	8.5	60 - 73	390
ZASO16	ZAPPA POLIVALENTE ASOLA		40 X 6	SQ	8.5	60 - 73	450
ZASO18	ZAPPA POLIVALENTE ASOLA SOPRA		40 X 6	SQ	8.5	60 - 73	460

Codice Code Ref. Re. Codigo	Marca e descrizione modello Brand name and model description Constructeur et description du modèle Marke und Modell Beschreibung Marca y modelo de descripción	Quote Dimensions Abmessungen Dimensiones 	Piatto Plate Platte Plaque 	Curvatura Curvature Corbure Krummung 	Foro Hole Trou Locher Hoyos Ø (mm)	Interasse Cent. Distance Achsenabstand Distancia entre ejes 	Peso Weight Gewicht Poids
---	--	---	---	---	---	--	--

ASOLA 60-73

ZASO21	ZAPPA POLIVALENTE ASOLA SOPRA		35 X 6	SQ	8.5	60 - 73	340
ZASO22	ZAPPA POLIVALENTE ASOLA SOPRA		35 X 6	C	8.5	60 - 73	300

ASOLA 65-73

ZASO20	ZAPPA POLIVALENTE ASOLA SOPRA		40 X 6	SQ	10.5	65 - 73	470
ZASO23	ZAPPA POLIVALENTE ASOLA SOPRA		40 X 6	C	10.5	65 - 73	400
ZASO24	ZAPPA POLIVALENTE ASOLA SOPRA		40 X 6	SQ	10.5	65 - 73	450
ZASO25	ZAPPA POLIVALENTE ASOLA SOPRA INTERNA		40 X 6	SQ	10.5	65 - 73	400
ZASO26	ZAPPA POLIVALENTE ASOLA SOPRA SVIRGOLATA		40 X 6	C	10.5	65 - 73	500

Codice Code Ref. Re. Codigo	Marca e descrizione modello Brand name and model description Constructeur et description du modèle Marke und Modell Beschreibung Marca y modelo de descripción	Quote Dimensions Abmessungen Dimensiones 	Piatto Plate Platte Plaque 	Curvatura Curvature Corbure Krummung 	Foro Hole Trou Locher Hoyos Ø (mm)	Interasse Cent. Distance Achsenabstand Distancia entre ejes 	Peso Weight Gewicht Poids
---	--	---	---	---	---	--	--

ASOLA 65-85

ZASO01	ZAPPA POLIVALENTE		40 X 6	C	10.5	65 - 85	440
ZASO01 SV27	ZAPPA POLIVALENTE		40 X 6	C	10.5	65 - 85	450
ZASO02	ZAPPA POLIVALENTE		45 X 6	C	10.5	65 - 85	530
ZASO02A	ZAPPA POLIVALENTE INTERNA		40 X 6	SQ	10.5	65 - 85	410
ZASO03	ZAPPA POLIVALENTE		50 X 6	C	10.5	65 - 85	680
ZASO04	ZAPPA POLIVALENTE		40 X 6	SQ	10.5	65 - 85	450
ZASO05	ZAPPA POLIVALENTE INTERNA		45 X 6	C	10.5	65 - 85	420
ZASO08	ZAPPA POLIVALENTE		45 X 6	SQ	10.5	65 - 85	500

Tutti gli articoli sono di nostra produzione e non originali. Pesì e misure sono puramente indicativi e possono essere modificati senza preavviso. La riproduzione anche parziale del presente catalogo è vietata. All articles are of our production and not original. Weights and measures are approximate and may change without notice. Reproduction of this catalog is prohibited. Tous les articles sont fabriqués par nous-mêmes et non d'origine. Les poids et mesurés sont approximatifs et peuvent changer sans préavis. Alle artikel werden von uns selbst hergestellt und nicht original. Masse und gewichte sind richtwerte und kan ohne vorank undigung gendert werden.

Codice Code Ref. Re. Codigo	Marca e descrizione modello Brand name and model description Constructeur et description du modèle Marke und Modell Beschreibung Marca y modelo de descripción	Quote Dimensions Abmessungen Dimensiones 	Piatto Plate Platte Plaque 	Curvatura Curvature Corbure Krummung 	Foro Hole Trou Locher Hoyos Ø (mm)	Interasse Cent. Distance Achsenabstand Distancia entre ejes 	Peso Weight Gewicht Poids
---	--	---	---	---	---	--	--

ASOLA 65-85

ZASO09	ZAPPA POLIVALENTE		50 X 6	SQ	10.5	65 - 85	590
ZASO10	ZAPPA POLIVALENTE INTERNA		40 X 6	C	10.5	65 - 85	400
ZASO11	ZAPPA POLIVALENTE INTERNA		50 X 6	SQ	10.5	65 - 85	500
ZASO12	ZAPPA POLIVALENTE INTERNA		45 X 6	SQ	10.5	65 - 85	450
ZASO17	ZAPPA POLIVALENTE INTERNA		50 X 6	C	10.5	65 - 85	500

ATTI

ZATT01	M200		25 X 5	C	8.5	66	180
--------	------	--	--------	---	-----	----	-----

AVR

ZAVR01	SAGOMATORE PATATE RIPORTO ANTIUSURA		50 X 12	-	12.5	80	1000
--------	--	--	---------	---	------	----	------

Codice Code Ref. Re. Codigo	Marca e descrizione modello Brand name and model description Constructeur et description du modèle Marke und Modell Beschreibung Marca y modelo de descripción	Quote Dimensions Abmessungen Dimensiones 	Piatto Plate Platte Plaque 	Curvatura Curvature Corbure Krummung 	Foro Hole Trou Locher Hoyos Ø (mm)	Interasse Cent. Distance Achsenabstand Distancia entre ejes 	Peso Weight Gewicht Poids
---	--	---	---	---	---	--	--



AVR

ZAVR02	SAGOMATORE PATATE RIPORTO ANTIUSURA		40 X 10	-	12.5	80	1000
ZAVR03	SAGOMATORE PATATE		50 X 12	-	16.5	80	900
ZAVR04	SAGOMATORE PATATE		40 X 10	-	12.5	80	900

BADALINI

ZBAD01	MA Cod Orig: 5034		45 X 6	C	10.5	30	300
ZBAD02	FRESA 777 - 777B MR - MS - 77 - 85		50 X 6	C Elicoidale	10.5	30	400
ZBAD06	MULTIFRESA F/777		50 X 6	SSQ	10.5	30	360
ZBAD07	MD - ME Cod Orig: 5154B		50 X 6	C Elicoidale	10.5	30	390

Tutti gli articoli sono di nostra produzione e non originali. Pesi e misure sono puramente indicativi e possono essere modificati senza preavviso. La riproduzione anche parziale del presente catalogo è vietata. All articles are of our production and not original. Weights and measures are approximate and may change without notice. Reproduction of this catalog is prohibited. Tous les articles sont fabriqués par nous-mêmes et non d'origine. Les poids et mesures sont approximatifs et peuvent changer sans préavis. Alle Artikel werden von uns selbst hergestellt und nicht original. Masse und Gewichte sind Richtwerte und können ohne Vorankündigung geändert werden.

Codice Code Ref. Re. Codigo	Marca e descrizione modello Brand name and model description Constructeur et description du modèle Marke und Modell Beschreibung Marca y modelo de descripción	Quote Dimensions Abmessungen Dimensiones 	Piatto Plate Platte Plaque 	Curvatura Curvature Corbure Krummung 	Foro Hole Trou Locher Hoyos Ø (mm)	Interasse Cent. Distance Achsenabstand Distancia entre ejes 	Peso Weight Gewicht Poids 
---	--	--	---	--	---	---	---

BADALINI

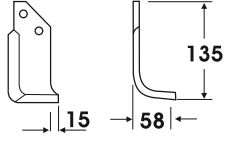
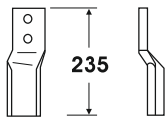
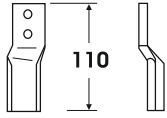
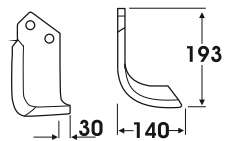
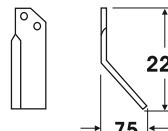
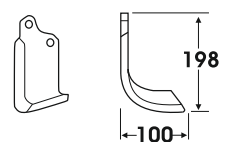
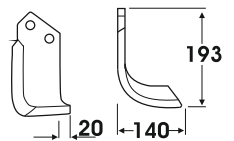
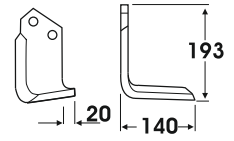
ZBAD08	MF 8243 Cod Orig: 8243		50 X 6	C Elicoidale	10.5	35	360
ZBAD09	COLTELLO TURBOLAMA FM Cod Orig: 6401		50 X 12	D	16.5	50	1000
ZBAD10	COLTELLO FM Cod Orig: 6108		50 X 12	D	14.5	40	650
ZBAD12	EC 2 - 3 Cod Orig: 3226		70 X 7	C Elicoidale	12.5	54	830
ZBAD15	COLTELLO TURBOLAMA FM Cod Orig: 6401A		70 X 10	-	16.5	50	1100
ZBAD18	FRESA Cod Orig: 5261		80 X 6	C	14.5	50	840
ZBAD19	EC 2 - 3		80 X 6	C	12.5	54	970
ZBAD20	EC 2 - 3		80 X 6	SQ Elicoidale	12.5	54	1030

Codice Code Ref. Re. Codigo	Marca e descrizione modello Brand name and model description Constructeur et description du modèle Marke und Modell Beschreibung Marca y modelo de descripción	Quote Dimensions Abmessungen Dimensiones 	Piatto Plate Platte Plaque 	Curvatura Curvature Corbure Krummung 	Foro Hole Trou Locher Hoyos Ø (mm)	Interasse Cent. Distance Achsenabstand Distancia entre ejes 	Peso Weight Gewicht Poids
---	--	---	---	---	---	--	--

BADALINI

ZBAD21	EC 2		80 X 7	C	14.5	50	1100
ZBAD23	FRESA MES Cod Orig: 8914		60 X 6	C Elicoidale	12.5	40	520
ZBAD24	ZAPPETTA		60 X 6	SQ	12.5	40	500

BAIANO

ZBAI01	Q 85 LUNGA SX		50 X 6	SQ	10.5	40	460
ZBAI02	Q 85 CORTA SX		50 X 6	SQ	10.5	40	400

BARBIERI

ZBAR01	JUNIOR		30 X 4	SQ	8.5	70	180
--------	--------	--	--------	----	-----	----	-----

Codice Code Ref. Re. Codigo	Marca e descrizione modello Brand name and model description Constructeur et description du modèle Marke und Modell Beschreibung Marca y modelo de descripción	Quote Dimensions Abmessungen Dimensiones 	Piatto Plate Platte Plaque 	Curvatura Curvature Corbure Krummung 	Foro Hole Trou Locher Hoyos Ø (mm) 	Interasse Cent. Distance Achsenabstand Distancia entre ejes 	Peso Weight Gewicht Poids
---	--	---	---	---	---	--	--

BARBIERI

ZBAR03	RL S1 SPECIAL		30 X 5	C Elicoidale	8.5	34	200
ZBAR04	RM MINI FRESA		30 X 5	C Elicoidale	8.5	34	200
ZBAR05	RL JOLLY - LASER MTZ 4 Cod Orig: 18062-3		30 X 5	SQ Elicoidale	8.5	68	230
ZBAR06	PONY		30 X 5	C	8.5	65	230
ZBAR07	JUNIOR II SERIE GHEPARD RLA 1 AIRONE		30 X 5	C	8.5	68	220
ZBAR08	RLA 3 - MTZ 7 Cod Orig: 2109-10		35 X 5	C	8.5	68	270
ZBAR09	CORTINA		40 X 5	C	8.5	68	330
ZBAR10	GAZZELLA RLG1 - B80 SUPER Cod Orig: 0606028-29		40 X 5	C	10.5	68	310

Tutti gli articoli sono di nostra produzione e non originali. Pesi e misure sono puramente indicativi e possono essere modificati senza preavviso. La riproduzione anche parziale del presente catalogo è vietata. All articles are of our production and not original. Weights and measures are approximate and may change without notice. Reproduction of this catalog is prohibited. Tous les articles sont fabriqués par nous-mêmes et non d'origine. Les poids et mesurent approximatifs et peuvent changer sans préavis. Alle artikel werden von uns selbst hergestellt und nicht original. Masse und gewichte sind richtwerte und kan ohne vorank undigung gendert werden.

Codice Code Ref. Re. Codigo	Marca e descrizione modello Brand name and model description Constructeur et description du modèle Marke und Modell Beschreibung Marca y modelo de descripción	Quote Dimensions Abmessungen Dimensiones 	Piatto Plate Platte Plaque 	Curvatura Curvature Corbure Krummung 	Foro Hole Trou Locher Hoyos Ø (mm)	Interasse Cent. Distance Achsenabstand Distancia entre ejes 	Peso Weight Gewicht Poids
---	--	---	---	---	---	--	--

BARBIERI

ZBAR11	SERIE 900		40 X 6	C	10.5	68	340
ZBAR12	GIAGUARO MCG - 14 SERIE1400		40 X 6	C	10.5	34	380
ZBAR13	GIAGUARO FB 1600 MCG 16 Cod Orig: 1606004-5		40 X 6	C Elicoidale	10.5	76	440
ZBAR14	RL C1 CONDOR		40 X 6	C	10.5	76	450
ZBAR15	RL C3 CONDOR		40 X 6	SQ	10.5	76	450
ZBAR16	MCG - 14 S1400 GIAGUARO		45 X 5	C	10.5	34	400
ZBAR17	MCG - 10 PIONIER SERIE1200		45 X 5	SSQ	10.5	80	340
ZBAR18	RL F2 1500 ZEBRA - ALCE		45 X 6	C	10.5	76	520

Tutti gli articoli sono di nostra produzione e non originali. Pesi e misure sono puramente indicativi e possono essere modificati senza preavviso. La riproduzione anche parziale del presente catalogo è vietata. All articles are of our production and not original. Weights and measures are approximate and may change without notice. Reproduction of this catalog is prohibited. Tous les articles sont fabriqués par nous-mêmes et non d'origine. Les poids et mesures sont approximatifs et peuvent changer sans préavis. Alle Artikel werden von uns selbst hergestellt und nicht original. Masse und Gewichte sind Richtwerte und können ohne Vorankündigung geändert werden.

Codice Code Ref. Re. Codigo	Marca e descrizione modello Brand name and model description Constructeur et description du modèle Marke und Modell Beschreibung Marca y modelo de descripción	Quote Dimensions Abmessungen Dimensiones 	Piatto Plate Platte Plaque 	Curvatura Curvature Corbure Krummung 	Foro Hole Trou Locher Hoyos Ø (mm)	Interasse Cent. Distance Achsenabstand Distancia entre ejes 	Peso Weight Gewicht Poids
---	--	---	---	---	---	--	--

BARBIERI

ZBAR19	RL C TIPO NUOVO		45 X 6	C	10.5	76	500
ZBAR20	GAZZELLA MAGGIORATA		45 X 6	C	10.5	68	520
ZBAR21	GAZZELLA MAGGIORATA		45 X 6	SQ	10.5	68	520
ZBAR22	RL F1		50 X 6	C	10.5	38	520
ZBAR23	RL F1		50 X 6	SQ	10.5	38	500
ZBAR24	RL F1 S 1500 ZEBRA		50 X 6	SQ	10.5	76	620
ZBAR25	RL F1 S 1500 ZEBRA - ALCE - FALCON Cod Orig: 1104-5		50 X 6	C	10.5	76	500
ZBAR26	MCG - 18 PANTERA		60 X 6	C	10.5	42	610

Tutti gli articoli sono di nostra produzione e non originali. Pesi e misure sono puramente indicativi e possono essere modificati senza preavviso. La riproduzione anche parziale del presente catalogo è vietata. All articles are of our production and not original. Weights and measures are approximate and may change without notice. Reproduction of this catalog is prohibited. Tous les articles sont fabriqués par nous-mêmes et non d'origine. Les poids et mesures sont approximatifs et peuvent changer sans préavis. Alle Artikel werden von uns selbst hergestellt und nicht original. Masse und Gewichte sind Richtwerte und können ohne Vorankündigung geändert werden.

Codice Code Ref. Re. Codigo	Marca e descrizione modello Brand name and model description Constructeur et description du modèle Marke und Modell Beschreibung Marca y modelo de descripción	Quote Dimensions Abmessungen Dimensiones 	Piatto Plate Platte Plaque 	Curvatura Curvature Corbure Krummung 	Foro Hole Trou Locher Hoyos Ø (mm)	Interasse Cent. Distance Achsenabstand Distancia entre ejes 	Peso Weight Gewicht Poids 
---	--	--	---	--	---	---	---

BARBIERI

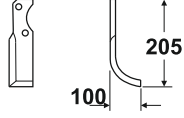
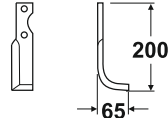

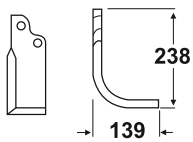
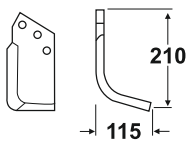

ZBAR28	MCG - 19 LEOPARD MAGGIORATA		60 X 6	C	10.5	76	660
ZBAR29	ZAPPA		45 X 6	SQ	8.5	68	420

BARONI

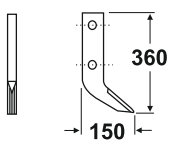
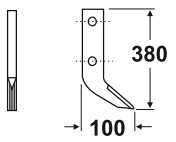

ZBAO02	EXPORT		60 X 8	C	14.5	56	850
ZBAO03	3 FORI		100 X 8	C	14.5	45	1200

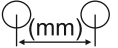

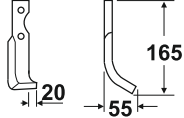
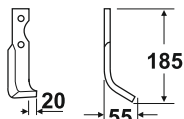

BASELIER

ZBSL01	SAGOMATORE PATATE RIPORTO ANTIUSURA		40 X 10	-	12.5	80	1150
ZBSL02	SAGOMATORE PATATE RIPORTO ANTIUSURA		50 X 12	-	14.5	100	1600

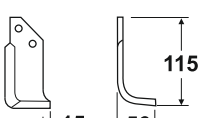
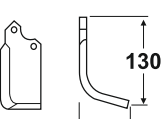
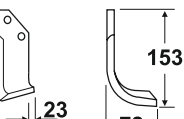
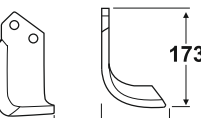
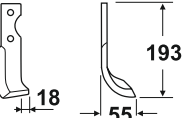
Codice Code Ref. Re. Codigo	Marca e descrizione modello Brand name and model description Constructeur et description du modèle Marke und Modell Beschreibung Marca y modelo de descripción	Quote Dimensions Abmessungen Dimensiones 	Piatto Plate Platte Plaque 	Curvatura Curvature Corbure Krummung 	Foro Hole Trou Locher Hoyos Ø (mm) 	Interasse Cent. Distance Achsenabstand Distancia entre ejes 	Peso Weight Gewicht Poids 
---	--	--	---	--	--	---	---

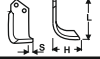
BCS

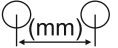
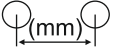
ZBCS01	715 Cod Orig: 43431-2		25 X 6	C Elicoidale	8.5	55	200
ZBCS02	715 AMERICA Cod Orig: 43433-34		25 X 6	C Elicoidale	8.5	55	240
ZBCS03	705 STANDARD Cod Orig: 42306-07		30 X 6	C Elicoidale	10.5	66	290
ZBCS04	725 Cod Orig: 48425-26		40 X 6	C	10.5	27	240
ZBCS05	735 SPAGNA Cod Orig: 48433-34		40 X 6	C	10.5	27	240
ZBCS06	705 PATERNO' Cod Orig: 42304-5		50 X 6	C Elicoidale	10.5	40	370
ZBCS07	745 - 766 SICILIA Cod Orig: 49707-8		60 X 8	C Elicoidale	12.5	46	650
ZBCS08	FRESA 20 720 - 740 - 732 Cod Orig: 59275-6		30 X 6	C Elicoidale	8.5	55	290

Codice Code Ref. Re. Codigo	Marca e descrizione modello Brand name and model description Constructeur et description du modèle Marke und Modell Beschreibung Marca y modelo de descripción	Quote Dimensions Abmessungen Dimensiones 	Piatto Plate Platte Plaque 	Curvatura Curvature Corbure Krummung 	Foro Hole Trou Locher Hoyos Ø (mm) 	Interasse Cent. Distance Achsenabstand Distancia entre ejes 	Peso Weight Gewicht Poids 
---	--	--	---	--	--	---	---

BCS

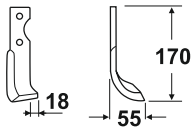
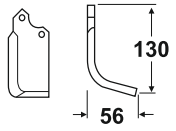
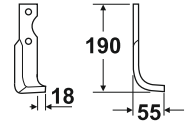
ZBCS09	FRESA 20 CORTA 720 - 740 Cod Orig: 59277-78		30 X 6	C Elicoidale	8.5	55	260
ZBCS10	735 LARGA Cod Orig: 48460-61		50 X 6	C	10.5	27	300
ZBCS11	ZAPPA FRESA SQUADRO Mod.738		30 X 6	SQ Elicoidale	8.5	55	290

BENASSI

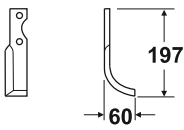
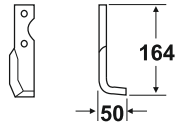
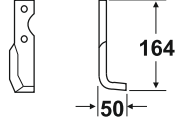
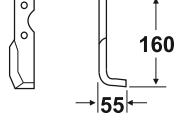
ZBEN01	BL 30 - 35 - 40 Cod Orig: 644011-12		30 X 4	C	8.5	68	180
ZBEN02	RT 45 - 401 Cod Orig: 6CM006-07		30 X 4	SQ	8.5	68	180
ZBEN04	RT 45 - 401		30 X 5	SQ	8.5	68	190
ZBEN06	RT 10 - 12 BN 9 - 10		30 X 5	SQ	8.5	68	200

Tutti gli articoli sono di nostra produzione e non originali. Pesi e misure sono puramente indicativi e possono essere modificati senza preavviso. La riproduzione anche parziale del presente catalogo è vietata. All articles are of our production and not original. Weights and measures are approximate and may change without notice. Reproduction of this catalog is prohibited. Tous les articles sont fabriqués par nous-mêmes et non d'origine. Les poids et mesures sont approximatifs et peuvent changer sans préavis. Alle artikel werden von uns selbst hergestellt und nicht original. Masse und gewichte sind richtwerte und kan ohne vorank undigung gendert werden.

Codice Code Ref. Re. Codigo	Marca e descrizione modello Brand name and model description Constructeur et description du modèle Marke und Modell Beschreibung Marca y modelo de descripción	Quote Dimensions Abmessungen Dimensiones 	Piatto Plate Platte Plaque 	Curvatura Curvature Corbure Krummung 	Foro Hole Trou Locher Hoyos Ø (mm)	Interasse Cent. Distance Achsenabstand Distancia entre ejes 	Peso Weight Gewicht Poids
---	--	---	---	---	---	--	--

BENASSI

ZBEN07	RT 10 - 12 BN 9 - 10 Cod Orig: 6CM300-01		30 X 5	C	8.5	68	200
ZBEN08	RT 8 - MF221 - 220 AN 7 - 8 RL 311 Cod Orig: 6CM014-15		30 X 5	C Elicoidale	8.5	68	210
ZBEN09	BL 30 - 35 - 45 - 450 - 4000 - 6000 Cod Orig: 644025-26		35 X 4	C Elicoidale	8.5	68	240
ZBEN10	RL 50 - RL A1 Cod Orig: 2804511-12		35 X 5	C	8.5	68	260
ZBEN11	RL 75 BL 55		35 X 5	SQ	8.5	68	300
ZBEN12	RL 75 - 319 - 328D Cod Orig: 6CM125-26		35 X 5	C	10.5	68	300
ZBEN15	RL 85 RL 7		35 X 6	SQ	8.5	68	360
ZBEN16	BL 75 - 85/Z3 Cod Orig: 6CM002-03		40 X 5	C	8.5	68	300

Tutti gli articoli sono di nostra produzione e non originali. Pesi e misure sono puramente indicativi e possono essere modificati senza preavviso. La riproduzione anche parziale del presente catalogo è vietata. All articles are of our production and not original. Weights and measures are approximate and may change without notice. Reproduction of this catalog is prohibited. Tous les articles sont fabriqués par nous-mêmes et non d'origine. Les poids et mesures sont approximatifs et peuvent changer sans préavis. Alle Artikel werden von uns selbst hergestellt und nicht original. Masse und Gewichte sind Richtwerte und können ohne Vorankündigung geändert werden.



Codice Code Ref. Re. Codigo	Marca e descrizione modello Brand name and model description Constructeur et description du modèle Marke und Modell Beschreibung Marca y modelo de descripción	Quote Dimensions Abmessungen Dimensiones 	Piatto Plate Platte Plaque 	Curvatura Curvature Corbure Krummung 	Foro Hole Trou Locher Hoyos Ø (mm)	Interasse Cent. Distance Achsenabstand Distancia entre ejes 	Peso Weight Gewicht Poids
---	--	---	---	---	---	--	--

BENASSI

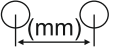
ZBEN17	BL 75 - 85/Z4 Cod Orig: 6CM004-5		40 X 5	SQ	8.5	68	330
ZBEN18	RL 308 BL 100 Cod Orig: 6CM113-14		40 X 6	C	10.5	68	440
ZBEN19	RL 308 Cod Orig: 6CM105-06		40 X 6	SQ Elicoidale	10.5	68	450
ZBEN20	RL 303 - 304 - 328		40 X 6	SQ	10.5	68	420
ZBEN21	RL 303 - 304 - 319 5 - 75 - 320 - 41 Cod Orig: 6CM142-43		40 X 6	C	10.5	68	380
ZBEN22	RL 9		40 X 6	C	10.5	80	420
ZBEN23	RL 9		40 X 6	SQ	10.5	80	450
ZBEN24	S 300 - 304 Cod Orig: 6CM010-11		45 X 6	C	10.5	68	490

Codice Code Ref. Re. Codigo	Marca e descrizione modello Brand name and model description Constructeur et description du modèle Marke und Modell Beschreibung Marca y modelo de descripción	Quote Dimensions Abmessungen Dimensiones 	Piatto Plate Platte Plaque 	Curvatura Curvature Corbure Krummung 	Foro Hole Trou Locher Hoyos Ø (mm) 	Interasse Cent. Distance Achsenabstand Distancia entre ejes 	Peso Weight Gewicht Poids 
---	--	--	---	--	--	---	---

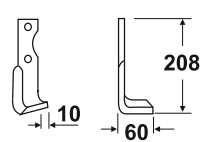
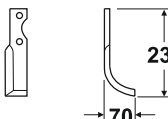
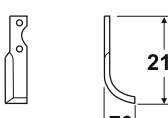
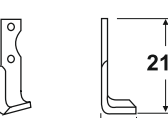
BENASSI

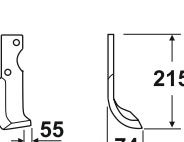
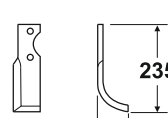
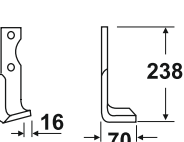
ZBEN25	S 300 - 304 Cod Orig: 6CM008-9		45 X 6	SQ Elicoidale	10.5	68	500
ZBEN26	RL 95 (12 - 4)		45 X 6	C	10.5	80	520
ZBEN27	RL 308 MAGGIORATA		45 X 6	C	10.5	68	520
ZBEN28	RL 308 MAGGIORATA		45 X 6	SQ	10.5	68	530
ZBEN29	RL 95 - 12		45 X 6	SQ	10.5	80	550
ZBEN30	BL 85 - 90 - 348 BL 105 - 110 - 120 Cod Orig: 644015-16		40 X 5	C	10.5	70	330
ZBEN31	RL 95 Cod Orig: 6CM020-21		50 X 6	C	10.5	80	600
ZBEN32	RL 95 Cod Orig: 6CM040-41		50 X 6	SQ Elicoidale	10.5	80	620

Codice Code Ref. Re. Codigo	Marca e descrizione modello Brand name and model description Constructeur et description du modèle Marke und Modell Beschreibung Marca y modelo de descripción	Quote Dimensions Abmessungen Dimensiones 	Piatto Plate Platte Plaque 	Curvatura Curvature Corbure Krummung 	Foro Hole Trou Locher Hoyos Ø (mm)	Interasse Cent. Distance Achsenabstand Distancia entre ejes 	Peso Weight Gewicht Poids
---	--	---	---	---	---	--	--

BENASSI

ZBEN33	MC 2300 - 240 - 250 Cod Orig: 644027-28		30 X 5	C	8.5	50	200
ZBEN41	FRESA 260 Cod Orig: 644035-36		30 X 4	C	8.5	-	100
ZBEN42	RL 5 SERIE 350 Cod Orig: 6CM138-39		30 X 5	C	8.5	65	230
ZBEN43	MF 223		30 X 5	C Elicoidale	10.5	68	210
ZBEN44	BL 250 Cod Orig: 644042-3		30 X 4	C	8.5	60	200

BERTOLINI - YABE - EMAK

ZBER01	BIETOLE		25 X 5	C	8.5	72	180
ZBER02	S 300 Cod Orig: 671013-14		30 X 6	C	8.5	81	350

Tutti gli articoli sono di nostra produzione e non originali. Pesi e misure sono puramente indicativi e possono essere modificati senza preavviso. La riproduzione anche parziale del presente catalogo è vietata. All articles are of our production and not original. Weights and measures are approximate and may change without notice. Reproduction of this catalog is prohibited. Tous les articles sont fabriqués par nous-mêmes et non d'origine. Les poids et mesures sont approximatifs et peuvent changer sans préavis. Alle Artikel werden von uns selbst hergestellt und nicht original. Masse und Gewichte sind Richtwerte und können ohne Vorankündigung geändert werden.

Codice Code Ref. Re. Codigo	Marca e descrizione modello Brand name and model description Constructeur et description du modèle Marke und Modell Beschreibung Marca y modelo de descripción	Quote Dimensions Abmessungen Dimensiones 	Piatto Plate Platte Plaque 	Curvatura Curvature Corbure Krummung 	Foro Hole Trou Locher Hoyos Ø (mm)	Interasse Cent. Distance Achsenabstand Distancia entre ejes 	Peso Weight Gewicht Poids
---	--	---	---	---	---	--	--

BERTOLINI - YABE - EMAK





ZBER03	S 305 HP 7,5		30 X 6	C Elicoidale	10.5	65	290
ZBER04	S 307 Cod Orig: 3362-3262		30 X 6	C	8.5	81	320
ZBER05	S 306 - 312 - 308 - 406 408 - 410 - 411 Cod Orig: 15517-18		30 X 6	SQ Elicoidale	8.5	55	280
ZBER07	BM 10 - 310 Cod Orig: 101909-10		35 X 8	C	10.5	58	500
ZBER10	S 318 Cod Orig: 16812-13		45 X 6	C	10.5	28	340
ZBER11	S 320 MODIFICATA		50 X 6	C	10.5	58	420
ZBER12	S 310 Cod Orig: 12522-23		50 X 6	C	12.5	90	600
ZBER13	S 315 Cod Orig: 13014-15		50 X 6	C	10.5	28	410

Codice Code Ref. Re. Codigo	Marca e descrizione modello Brand name and model description Constructeur et description du modèle Marke und Modell Beschreibung Marca y modelo de descripción	Quote Dimensions Abmessungen Dimensiones 	Piatto Plate Platte Plaque 	Curvatura Curvature Corbure Krummung 	Foro Hole Trou Locher Hoyos Ø (mm)	Interasse Cent. Distance Achsenabstand Distancia entre ejes 	Peso Weight Gewicht Poids
---	--	---	---	---	---	--	--

BERTOLINI - YABE - EMAK

ZBER15	S 310 - 320 UNIFICATO HP 24 Cod Orig: 12031-32		50 X 7	C	12.5	90	750
ZBER16	BM 12		40 X 8	C	12.5	41	520
ZBER17	S 320 HP 24		60 X 6	C	12.5	90	750
ZBER18	S 320 - 420 HP 24		60 X 6	SQ	12.5	90	800
ZBER19	S 310 - 320		60 X 6	C	12.5	90	780
ZBER20	S 320 - 420 MAGGIORATA		70 X 7	SQ	12.5	90	1000
ZBER21	401 - 402 - 403 405 S - 309 Cod Orig: 17002-03		30 X 6	SQ Elicoidale	8.5	55	250
ZBER23	315 - 318		50 X 6	SSQ	10.5	28	500

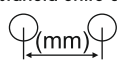
Tutti gli articoli sono di nostra produzione e non originali. Pesi e misure sono puramente indicativi e possono essere modificati senza preavviso. La riproduzione anche parziale del presente catalogo è vietata. All articles are of our production and not original. Weights and measures are approximate and may change without notice. Reproduction of this catalog is prohibited. Tous les articles sont fabriqués par nous-mêmes et non d'origine. Les poids et mesures sont approximatifs et peuvent changer sans préavis. Alle Artikel werden von uns selbst hergestellt und nicht original. Masse und Gewichte sind Richtwerte und können ohne Vorankündigung geändert werden.

Codice Code Ref. Re. Codigo	Marca e descrizione modello Brand name and model description Constructeur et description du modèle Marke und Modell Beschreibung Marca y modelo de descripción	Quote Dimensions Abmessungen Dimensiones 	Piatto Plate Platte Plaque 	Curvatura Curvature Corbure Krummung 	Foro Hole Trou Locher Hoyos Ø (mm)	Interasse Cent. Distance Achsenabstand Distancia entre ejes 	Peso Weight Gewicht Poids 
---	--	--	---	--	---	---	---

BERTOLINI - YABE - EMAK

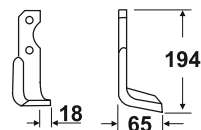
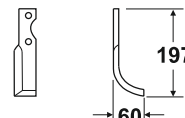
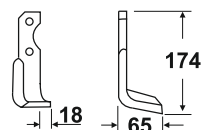
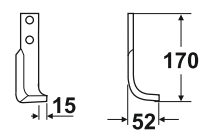
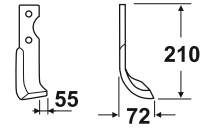
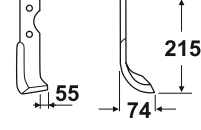
ZBER24	410 - 411 Cod Orig: 15602-03		35 X 6	SQ Elicoidale	8.5	55	330
ZBER25	201 E - 202 E Cod Orig: 1233102-03		30 X 4	C	8.5	65	200
ZBER26	309 - 312 - 408 Cod Orig: 15560-61		30 X 6	SQ Elicoidale	8.5	55	260
ZBER27	MOTOCOLTIVATORE 401		25 X 5	C Elicoidale	8.5	58	200
ZBER28	106 - 206 Cod Orig: 132311442		40 X 4	C Elicoidale	8.5	70	290
ZBER29	MT 2 - 218		40 X 5	C Elicoidale	10.5	70	320

BONFIGLIOLI

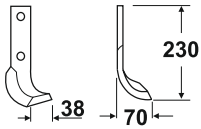

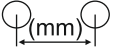
ZBON01	INTERFILARE		35 X 8	C	10.5	105	550
--------	-------------	---	--------	---	------	-----	-----

Codice Code Ref. Re. Codigo	Marca e descrizione modello Brand name and model description Constructeur et description du modèle Marke und Modell Beschreibung Marca y modelo de descripción	Quote Dimensions Abmessungen Dimensiones 	Piatto Plate Platte Plaque 	Curvatura Curvature Corbure Krummung 	Foro Hole Trou Locher Hoyos Ø (mm) 	Interasse Cent. Distance Achsenabstand Distancia entre ejes 	Peso Weight Gewicht Poids 
---	--	--	---	--	--	---	---

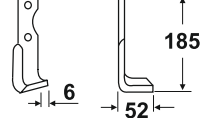
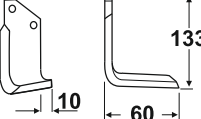
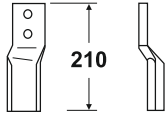
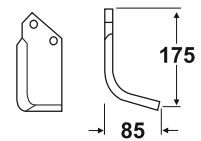
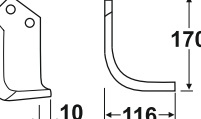
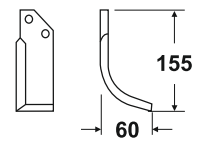
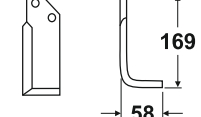
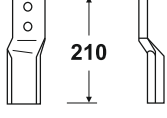
BREVIGLIERI

ZBRE01	BIETOLA M21 Cod Orig: 15219		30 X 6	SQ Elicoidale	8.5	70	300
ZBRE02	MULTIPLA MB - MBE S 10021 Cod Orig: 8300043-44		50 X 6	SQ Elicoidale	10.5	35	370
ZBRE03	DENTE B71V - B101V Cod Orig: 71091		50 X 10	D	14.5	44	800
ZBRE04	2MB SPECIAL		60 X 6	C	12.5	40	500
ZBRE05	B10 - B20 - B30S Cod Orig: 30104		60 X 6	C Elicoidale	12.5	40	570
ZBRE06	MG		60 X 6	C	12.5	40	500
ZBRE07	MG Cod Orig: 89275		60 X 6	SQ	12.5	40	460
ZBRE08	DENTE B200V Cod Orig: 50175		60 X 10	D	16.5	44	920

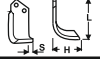
Tutti gli articoli sono di nostra produzione e non originali. Pesi e misure sono puramente indicativi e possono essere modificati senza preavviso. La riproduzione anche parziale del presente catalogo è vietata. All articles are of our production and not original. Weights and measures are approximate and may change without notice. Reproduction of this catalog is prohibited. Tous les articles sont fabriqués par nous-mêmes et non d'origine. Les poids et mesures sont approximatifs et peuvent changer sans préavis. Alle artikel werden von uns selbst hergestellt und nicht original. Masse und gewichte sind richtwerte und kan ohne vorank undigung gendert werden.

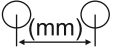
Codice Code Ref. Re. Codigo	Marca e descrizione modello Brand name and model description Constructeur et description du modèle Marke und Modell Beschreibung Marca y modelo de descripción	Quote Dimensions Abmessungen Dimensiones 	Piatto Plate Platte Plaque 	Curvatura Curvature Corbure Krummung 	Foro Hole Trou Locher Hoyos Ø (mm) 	Interasse Cent. Distance Achsenabstand Distancia entre ejes 	Peso Weight Gewicht Poids 
---	--	--	---	--	--	---	---

BREVIGLIERI

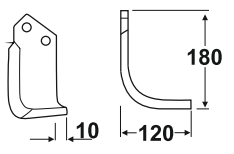
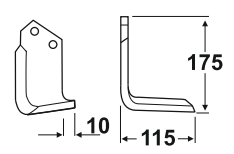
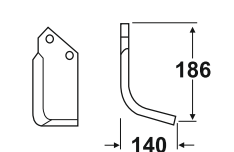
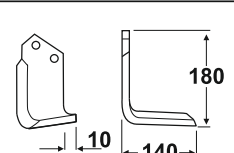
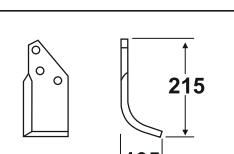
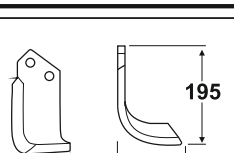
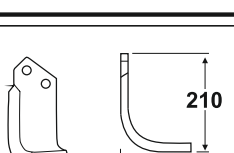
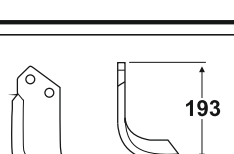
ZBRE09	B1 - B25 - B45 - BS Cod Orig: 830020-21		70 X 6	C Elicoidale	12.5	40	710
ZBRE10	B1 - B25 - B45 - BS Cod Orig: 830022-23		70 X 6	SQ Elicoidale	12.5	40	710
ZBRE12	B2 - B12 - BV2 - B2 B12 - B72 Cod Orig: 40105		80 X 7	C	12.5	57	1000
ZBRE13	B2 - B12 - BV2 - B72		80 X 7	SQ Elicoidale	12.5	57	1050
ZBRE14	3 FORI B 150 - B 300 Cod Orig: 66046		90 X 8	C	14.5	39 - 76	1280
ZBRE15	B15 - B2S - B12		80 X 7	C Elicoidale	14.5	57	980
ZBRE16	B3 - B14 - B101 Cod Orig: 3061		80 X 8	C Elicoidale	14.5	46	1130
ZBRE17	B72 - B120 - B100 B70 Cod Orig: 64811		80 X 8	C	14.5	57	1180

Tutti gli articoli sono di nostra produzione e non originali. Pesi e misure sono puramente indicativi e possono essere modificati senza preavviso. La riproduzione anche parziale del presente catalogo è vietata. All articles are of our production and not original. Weights and measures are approximate and may change without notice. Reproduction of this catalog is prohibited. Tous les articles sont fabriqués par nous-mêmes et non d'origine. Les poids et mesurent approximatifs et peuvent changer sans préavis. Alle artikel werden von uns selbst hergestellt und nicht original. Masse und gewichte sind richtwerte und kan ohne vorank undigung gendert werden.

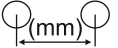
Codice Code Ref. Re. Codigo	Marca e descrizione modello Brand name and model description Constructeur et description du modèle Marke und Modell Beschreibung Marca y modelo de descripción	Quote Dimensions Abmessungen Dimensiones 	Piatto Plate Platte Plaque 	Curvatura Curvature Corbure Krummung 	Foro Hole Trou Locher Hoyos Ø (mm) 	Interasse Cent. Distance Achsenabstand Distancia entre ejes 	Peso Weight Gewicht Poids 
---	--	--	---	--	--	---	---



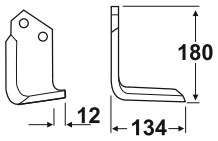
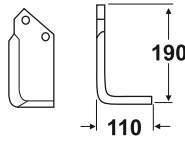
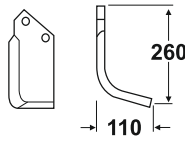
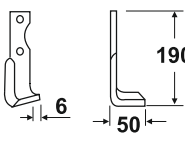
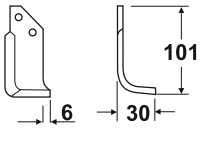

BREVIGLIERI

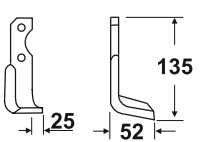
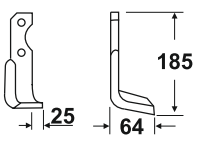
ZBRE18	B15 - B14V - B200 Cod Orig: 64818		80 X 8	SQ	14.5	57	1290
ZBRE19	B3 - B4 - B14		80 X 8	SQ Elicoidale	14.5	46	1290
ZBRE20	B4V - 22BRE		90 X 8	C Elicoidale	14.5	77	1350
ZBRE25	BIETOLA MAGGIORATA		35 X 6	SQ	8.5	70	350
ZBRE28	MM Cod Orig: 11077		50 X 5	C Elicoidale	8.5	40	210

BRUMITAL

ZBRU01	PULCE Cod Orig: 02Z08-09		30 X 4	SQ Elicoidale	8.5	44	160
ZBRU02	MINI KLEIN Cod Orig: 04Z04-05		30 X 6	SQ Elicoidale	8.5	60	270

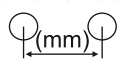
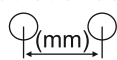
Tutti gli articoli sono di nostra produzione e non originali. Pesi e misure sono puramente indicativi e possono essere modificati senza preavviso. La riproduzione anche parziale del presente catalogo è vietata. All articles are of our production and not original. Weights and measures are approximate and may change without notice. Reproduction of this catalog is prohibited. Tous les articles sont fabriqués par nous-mêmes et non d'origine. Les poids et mesures sont approximatifs et peuvent changer sans préavis. Alle Artikel werden von uns selbst hergestellt und nicht original. Masse und Gewichte sind Richtwerte und können ohne Vorankündigung geändert werden.

Codice Code Ref. Re. Codigo	Marca e descrizione modello Brand name and model description Constructeur et description du modèle Marke und Modell Beschreibung Marca y modelo de descripción	Quote Dimensions Abmessungen Dimensiones 	Piatto Plate Platte Plaque 	Curvatura Curvature Corbure Krummung 	Foro Hole Trou Locher Hoyos Ø (mm) 	Interasse Cent. Distance Achsenabstand Distancia entre ejes 	Peso Weight Gewicht Poids 
---	--	--	---	--	--	---	---

BRUMITAL

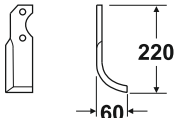
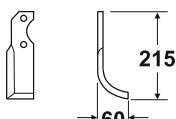
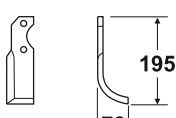
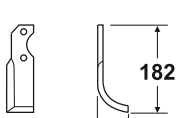
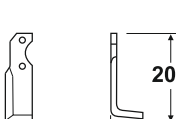
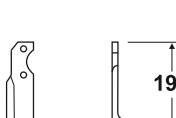
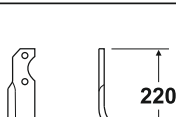
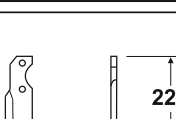
ZBRU03	TIPO VECCHIO		35 X 6	C	8.5	70	350
ZBRU05	TIPO VECCHIO		35 X 6	SQ	8.5	70	370
ZBRU07	MAXI KLEIN SUPER		35 X 6	C	8.5	60	330
ZBRU08	MAXI KLEIN SUPER INTERNA		35 X 6	C	8.5	60	310
ZBRU09	MAXI KLEIN SUPER		35 X 6	SQ	8.5	60	350
ZBRU10	MAXI KLEIN SUPER INTERNA		35 X 6	SQ	8.5	60	340
ZBRU11	DS 10 DIESEL Cod Orig: 20809003-04		40 X 6	C	10.5	70	450
ZBRU12	DS 10 DIESEL Cod Orig: 20Z05-06		40 X 6	SQ	10.5	70	460

Codice Code Ref. Re. Codigo	Marca e descrizione modello Brand name and model description Constructeur et description du modèle Marke und Modell Beschreibung Marca y modelo de descripción	Quote Dimensions Abmessungen Dimensiones 	Piatto Plate Platte Plaque 	Curvatura Curvature Corbure Krummung 	Foro Hole Trou Locher Hoyos Ø (mm)	Interasse Cent. Distance Achsenabstand Distancia entre ejes 	Peso Weight Gewicht Poids
---	--	---	---	---	---	--	--

BRUMITAL

ZBRU13	DS 10 DIESEL INTERNA Cod Orig: 503000011		40 X 6	C	10.5	70	370
ZBRU14	DS 10 DIESEL INTERNA Cod Orig: 20207-08		40 X 6	SQ	10.5	70	410
ZBRU15	DS 12 RECORD		45 X 6	SQ Elicoidale	10.5	70	470
ZBRU16	DS 12 RECORD INTERNA		45 X 6	SQ Elicoidale	10.5	70	430
ZBRU17	DS 12 RECORD		45 X 6	C	10.5	70	530
ZBRU18	DS 12 RECORD INTERNA		45 X 6	C	10.5	70	500
ZBRU19	ROTOFRESA MULETTO		50 X 6	C	10.5	37.5	460
ZBRU20	ROTOFRESA MULETTO INTERNA		50 X 6	C	10.5	37.5	410

Tutti gli articoli sono di nostra produzione e non originali. Pesi e misure sono puramente indicativi e possono essere modificati senza preavviso. La riproduzione anche parziale del presente catalogo è vietata. All articles are of our production and not original. Weights and measures are approximate and may change without notice. Reproduction of this catalog is prohibited. Tous les articles sont fabriqués par nous-même et non d'origine. Les poids et mesurent approximatifs et peuvent changer sans préavis. Alle artikel werden von uns selbst hergestellt und nicht original. Masse und gewichte sind richtwerte und kan ohne vorank undigung gendert werden.

Codice Code Ref. Re. Codigo	Marca e descrizione modello Brand name and model description Constructeur et description du modèle Marke und Modell Beschreibung Marca y modelo de descripción	Quote Dimensions Abmessungen Dimensiones 	Piatto Plate Platte Plaque 	Curvatura Curvature Corbure Krummung 	Foro Hole Trou Locher Hoyos Ø (mm)	Interasse Cent. Distance Achsenabstand Distancia entre ejes 	Peso Weight Gewicht Poids
---	--	---	---	---	---	--	--

BRUMITAL

ZBRU23	RECORD Cod Orig: 49Z10-12		50 X 6	C	10.5	70	600
ZBRU24	RECORD INTERNA Cod Orig: 49Z09-11		50 X 6	C	10.5	70	550
ZBRU25	TIPO SICILIA		50 X 6	SQ	10.5	70	600
ZBRU26	TIPO SICILIA INTERNA		50 X 6	SQ	10.5	70	50
ZBRU29	MINI SPECIAL INTERNA Cod Orig: 09Z11-12		35 X 5	C	8.5	60	270
ZBRU30	MINI SPECIAL Cod Orig: 502005007-08		35 X 5	C	8.5	60	280
ZBRU35	MINI KLEIN Cod Orig: 204097001-02		30 X 5	C	8.5	60	190
ZBRU41	NUOVA PULCE 4 T		30 X 4	C	8.5	55	190

Tutti gli articoli sono di nostra produzione e non originali. Pesi e misure sono puramente indicativi e possono essere modificati senza preavviso. La riproduzione anche parziale del presente catalogo è vietata. All articles are of our production and not original. Weights and measures are approximate and may change without notice. Reproduction of this catalog is prohibited. Tous les articles sont fabriqués par nous-mêmes et non d'origine. Les poids et mesures sont approximatifs et peuvent changer sans préavis. Alle Artikel werden von uns selbst hergestellt und nicht original. Masse und Gewichte sind Richtwerte und können ohne Vorankündigung geändert werden.

Codice Code Ref. Re. Codigo	Marca e descrizione modello Brand name and model description Constructeur et description du modèle Marke und Modell Beschreibung Marca y modelo de descripción	Quote Dimensions Abmessungen Dimensiones 	Piatto Plate Platte Plaque 	Curvatura Curvature Corbure Krummung 	Foro Hole Trou Locher Hoyos Ø (mm)	Interasse Cent. Distance Achsenabstand Distancia entre ejes 	Peso Weight Gewicht Poids
---	--	---	---	---	---	--	--

CAB

ZCAB01	RINGO M10		50 X 6	SQ	10.5	30	390
--------	-----------	--	--------	----	------	----	-----

CALDERONI

ZCAL01	INTERFILARE FPS - FPF - FPP Cod Orig: 7018		40 X 8	C Elicoidale	10.5	106	650
ZCAL02	ZAPPA		35 X 8	C Elicoidale	10.5	55	420
ZCAL03	ZAPPA CORTA		35 X 8	C Elicoidale	10.5	55	370
ZCAL04	ZAPPA		40 X 8	C Elicoidale	12.5	40	500
ZCAL05	ZAPPA SQUADRO		40 X 8	SQ	10.5	106	660

CAPASSO

ZCAP02	TIPO PESANTE		80 X 7	SQ	12.5	55	1040
--------	--------------	--	--------	----	------	----	------

Codice Code Ref. Re. Codigo	Marca e descrizione modello Brand name and model description Constructeur et description du modèle Marke und Modell Beschreibung Marca y modelo de descripción	Quote Dimensions Abmessungen Dimensiones 	Piatto Plate Platte Plaque 	Curvatura Curvature Corbure Krummung 	Foro Hole Trou Locher Hoyos Ø (mm)	Interasse Cent. Distance Achsenabstand Distancia entre ejes 	Peso Weight Gewicht Poids
---	--	---	---	---	---	--	--

CARRARO ANTONIO

ZCAA01	CARRARINO MINI HP 8 Cod Orig: 6809007-08		30 X 6	C Elicoidale	8.5	55	300
ZCAA02	CARRARINO MINI HP 8 Cod Orig: 37935004-05		30 X 6	SQ Elicoidale	8.5	55	300
ZCAA04	CARRARINO SUPER Cod Orig: 6809002-06		50 X 6	C	12.5	45	500
ZCAA05	CARRARINO SUPER		50 X 6	SQ	12.5	45	540

CARRARO S.P.A.





ZCAR01	ROTOCAR SUPER Serie 27		60 X 6	C	12.5	44	600
ZCAR02	ROTOCAR 3 FORI PANTHER		80 X 7	C	12.5	34 - 34	1100
ZCAR03	ROTOCAR 3 FORI PANTHER		80 X 7	SQ	12.5	34 - 34	1000

Codice Code Ref. Re. Codigo	Marca e descrizione modello Brand name and model description Constructeur et description du modèle Marke und Modell Beschreibung Marca y modelo de descripción	Quote Dimensions Abmessungen Dimensiones 	Piatto Plate Platte Plaque 	Curvatura Curvature Corbure Krummung 	Foro Hole Trou Locher Hoyos Ø (mm)	Interasse Cent. Distance Achsenabstand Distancia entre ejes 	Peso Weight Gewicht Poids
---	--	---	---	---	---	--	--





CASORZO

ZCAS01	PONY Cod Orig: 20140-134		30 X 6	C	8.5	72	300
ZCAS02	CU 125		30 X 6	C Elicoidale	8.5	72	300
ZCAS03	SU3 - CU6		35 X 6	C Elicoidale	8.5	72	340
ZCAS04	MERIDIONE SU4 TIPO VECCHIO		35 X 6	C	10.5	72	350
ZCAS05	VIGNETO CU6 CORTA		35 X 6	SQ Elicoidale	8.5	72	340
ZCAS06	VIGNETO SU4 LUNGA		35 X 6	SQ Elicoidale	8.5	72	400
ZCAS07	CIPRO SU4 - CU6 DIESEL		45 X 5	C	8.5	72	400
ZCAS08	CIPRO SU4 - CU6 DIESEL		45 X 6	C	10.5	72	340

Tutti gli articoli sono di nostra produzione e non originali. Pesì e misure sono puramente indicativi e possono essere modificati senza preavviso. La riproduzione anche parziale del presente catalogo è vietata. All articles are of our production and not original. Weights and measures are approximate and may change without notice. Reproduction of this catalog is prohibited. Tous les articles sont fabriqués par nous-mêmes et non d'origine. Les poids et mesures sont approximatifs et peuvent changer sans préavis. Alle Artikel werden von uns selbst hergestellt und nicht original. Masse und Gewichte sind Richtwerte und können ohne Vorankündigung geändert werden.

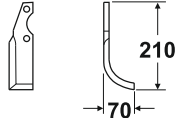
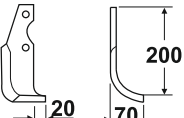
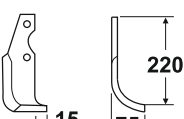
Codice Code Ref. Re. Codigo	Marca e descrizione modello Brand name and model description Constructeur et description du modèle Marke und Modell Beschreibung Marca y modelo de descripción	Quote Dimensions Abmessungen Dimensiones 	Piatto Plate Platte Plaque 	Curvatura Curvature Corbure Krummung 	Foro Hole Trou Locher Hoyos Ø (mm) 	Interasse Cent. Distance Achsenabstand Distancia entre ejes 	Peso Weight Gewicht Poids 
---	--	--	---	--	--	---	---

CASORZO

ZCAS09	SU4 - CU6 - SU - CU6 DIESEL		45 X 6	SQ	10.5	72	400
ZCAS10	SU4 - CU6 TIPO NUOVO		50 X 6	C Elicoidale	10.5	72	400
ZCAS11	TIPO NUOVO		45 X 5	C Elicoidale	10.5	72	450
ZCAS12	SU4 - CU6 Cod Orig: 91020832		45 X 5	C Elicoidale	10.5	72	380
ZCAS13	CU6		45 X 6	C Elicoidale	8.5	72	460
ZCAS14	CU6 CORTA		45 X 6	C Elicoidale	8.5	72	440

CAVAGION

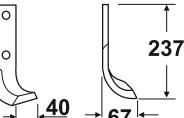
ZCAV01	INTERFILARE		35 X 8	C Elicoidale	10.5	112	550
--------	-------------	---	--------	-----------------	------	-----	-----

Codice Code Ref. Re. Codigo	Marca e descrizione modello Brand name and model description Constructeur et description du modèle Marke und Modell Beschreibung Marca y modelo de descripción	Quote Dimensions Abmessungen Dimensiones 	Piatto Plate Platte Plaque 	Curvatura Curvature Corbure Krummung 	Foro Hole Trou Locher Hoyos Ø (mm) 	Interasse Cent. Distance Achsenabstand Distancia entre ejes 	Peso Weight Gewicht Poids 
---	--	--	---	--	--	---	---

CELLI

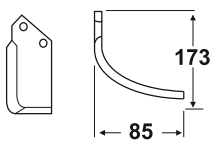
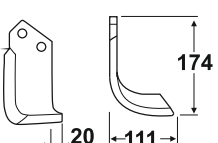
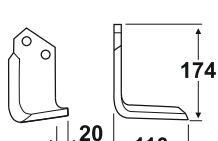
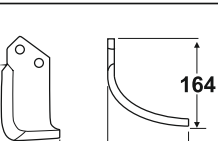
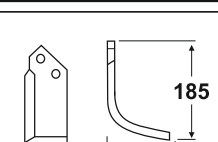
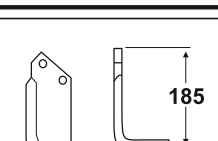
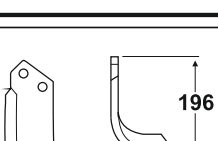
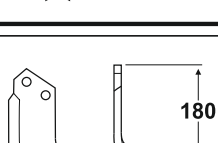
ZCEL02	KIWI HV - HF Cod Orig: 522606-07		60 X 6	C	12.5	44	550
ZCEL03	AL - BA - HBA - FBA Cod Orig: 522600-01		60 X 6	C Elicoidale	12.5	44	600
ZCEL04	AL - BA - HBA - FBA Cod Orig: 522602-03		60 X 6	SQ Elicoidale	12.5	44	620
ZCEL05	AG Cod Orig: 531511-12		60 X 6	C Elicoidale	12.5	40	580
ZCEL06	A - HP25 - 30 Cod Orig: 522505-06		70 X 6	C	12.5	50	720
ZCEL07	A - HP 25 - 30 Cod Orig: 522514-15		70 X 6	SQ Elicoidale	12.5	50	800
ZCEL08	CE Cod Orig: 331528-29		70 X 7	C Elicoidale	14.5	50	920
ZCEL09	CE Cod Orig: 331526-27		70 X 7	SQ Elicoidale	14.5	50	980

Tutti gli articoli sono di nostra produzione e non originali. Pesi e misure sono puramente indicativi e possono essere modificati senza preavviso. La riproduzione anche parziale del presente catalogo è vietata. All articles are of our production and not original. Weights and measures are approximate and may change without notice. Reproduction of this catalog is prohibited. Tous les articles sont fabriqués par nous-mêmes et non d'origine. Les poids et mesurent approximatifs et peuvent changer sans préavis. Alle artikel werden von uns selbst hergestellt und nicht original. Masse und gewichte sind richtwerte und kan ohne vorank undigung gendert werden.

Codice Code Ref. Re. Codigo	Marca e descrizione modello Brand name and model description Constructeur et description du modèle Marke und Modell Beschreibung Marca y modelo de descripción	Quote Dimensions Abmessungen Dimensiones 	Piatto Plate Platte Plaque 	Curvatura Curvature Corbure Krummung 	Foro Hole Trou Locher Hoyos Ø (mm)	Interasse Cent. Distance Achsenabstand Distancia entre ejes 	Peso Weight Gewicht Poids
---	--	---	---	---	---	--	--

CELLI

ZCEL11	ELICA CORTA Cod Orig: 422516-17		70 X 8	C	14.5	65	1100
ZCEL12	G LUNGA Cod Orig: 722535-36		80 X 8	SQ	14.5	57	1900
ZCEL14	B - BS INTERFILARE Cod Orig: 322518-19		80 X 6	C Elicoidale	14.5	57	820
ZCEL15	B - BS INTERFILARE Cod Orig: 322516-17		80 X 6	SQ Elicoidale	14.5	57	840
ZCEL16	E - F - HV - HF NUOVA PIEGATURA SPOSTABILE		80 X 7	C	14.5	57	980
ZCEL17	E - F - HV - HF Cod Orig: 422514-15		80 X 7	C Elicoidale	14.5	57	1020
ZCEL18	E - F - HV - HF Cod Orig: 422512-13		80 X 7	SQ Elicoidale	14.5	57	1050
ZCEL19	G - FK Cod Orig: 722537-38		80 X 8	C Elicoidale	14.5	57	1260

Tutti gli articoli sono di nostra produzione e non originali. Pesi e misure sono puramente indicativi e possono essere modificati senza preavviso. La riproduzione anche parziale del presente catalogo è vietata. All articles are of our production and not original. Weights and measures are approximate and may change without notice. Reproduction of this catalog is prohibited. Tous les articles sont fabriqués par nous-même et non d'origine. Les poids et mesurent approximatifs et peuvent changer sans preavis. Alle artikel werden von uns selbst hergestellt und nicht original. Masse und gewichte sind richtwerte und kan ohne vorank undigung gendert werden.

Codice Code Ref. Re. Codigo	Marca e descrizione modello Brand name and model description Constructeur et description du modèle Marke und Modell Beschreibung Marca y modelo de descripción	Quote Dimensions Abmessungen Dimensiones 	Piatto Plate Platte Plaque 	Curvatura Curvature Corbure Krummung 	Foro Hole Trou Locher Hoyos Ø (mm) 	Interasse Cent. Distance Achsenabstand Distancia entre ejes 	Peso Weight Gewicht Poids 
---	--	--	---	--	--	---	---

CELLI

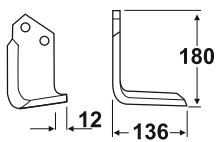
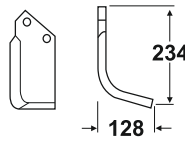
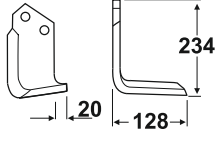
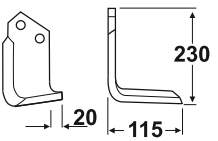
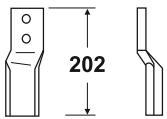
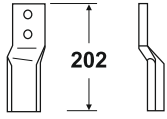
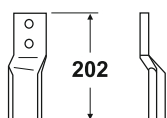
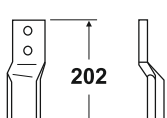
ZCEL20	G - FK Cod Orig: 722533-34		80 X 8	SQ Elicoidale	14.5	57	1400
ZCEL21	QS TIPO SICILIA		80 X 8	C Elicoidale	14.5	63	1200
ZCEL22	QS TIPO SICILIA		80 X 8	SQ	14.5	63	1300
ZCEL23	QS TIPO SICILIA CORTA		80 X 8	SQ	14.5	63	1200
ZCEL24	DENTE FRANGOR		50 X 10	D	14.5	45	800
ZCEL25	DENTE FRANGOR FE Cod Orig: 422530-31		50 X 10	D	16.5	45	800
ZCEL26	DENTE FRANGOR		50 X 12	D	14.5	45	900
ZCEL27	DENTE FRANGOR FK Cod Orig: 433630-31		50 X 12	D	16.5	45	900

Tutti gli articoli sono di nostra produzione e non originali. Pesi e misure sono puramente indicativi e possono essere modificati senza preavviso. La riproduzione anche parziale del presente catalogo è vietata. All articles are of our production and not original. Weights and measures are approximate and may change without notice. Reproduction of this catalog is prohibited. Tous les articles sont fabriqués par nous-mêmes et non d'origine. Les poids et mesures sont approximatifs et peuvent changer sans préavis. Alle Artikel werden von uns selbst hergestellt und nicht original. Masse und Gewichte sind Richtwerte und können ohne Vorankündigung geändert werden.

Codice Code Ref. Re. Codigo	Marca e descrizione modello Brand name and model description Constructeur et description du modèle Marke und Modell Beschreibung Marca y modelo de descripción	Quote Dimensions Abmessungen Dimensiones 	Piatto Plate Platte Plaque 	Curvatura Curvature Corbure Krummung 	Foro Hole Trou Locher Hoyos Ø (mm) 	Interasse Cent. Distance Achsenabstand Distancia entre ejes 	Peso Weight Gewicht Poids 
---	--	--	---	--	--	---	---

CELLI

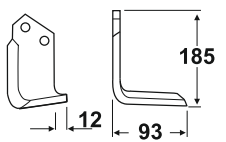
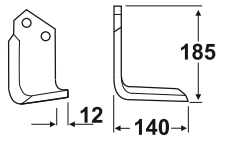
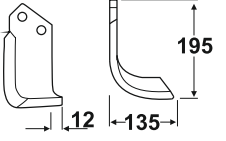
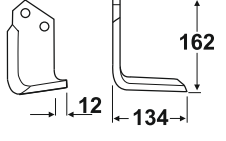
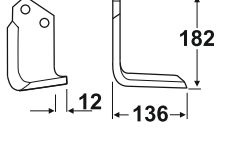
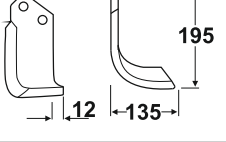
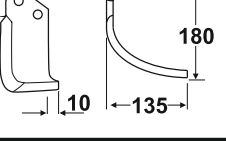
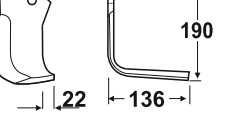
ZCEL30	G CORTA		80 X 8	SQ	14.5	57	1050
ZCEL31	HP 100 RINFORZATA Cod Orig: 722547-48		80 X 10	SQ	14.5	57	1500
ZCEL32	HP 100 RINFORZATA Cod Orig: 722557-58		80 X 10	C	14.5	57	1600
ZCEL33	E CORTA		80 X 7	SQ	14.5	57	900
ZCEL34	RINFORZATA Cod Orig: 722560-61		80 X 10	SQ	16.5	57	1650
ZCEL35	RINFORZATA Cod Orig: 722562-63		80 X 10	C	16.5	57	1600
ZCEL36	RINFORZATA NUOVA PIEGATURA SPOSTABILE		80 X 10	C	14.5	57	1300
ZCEL38	ZAPPA SGANGIO RAPIDO Cod Orig: 722572-73		80 X 10	SQ Elicoidale	16.5	-	1610

Tutti gli articoli sono di nostra produzione e non originali. Pesi e misure sono puramente indicativi e possono essere modificati senza preavviso. La riproduzione anche parziale del presente catalogo è vietata. All articles are of our production and not original. Weights and measures are approximate and may change without notice. Reproduction of this catalog is prohibited. Tous les articles sont fabriqués par nous-même et non d'origine. Les poids et mesurent approximatifs et peuvent changer sans preavis. Alle artikel werden von uns selbst hergestellt und nicht original. Masse und gewichte sind richtwerte und kan ohne vorank undigung gendert werden.

Codice Code Ref. Re. Codigo	Marca e descrizione modello Brand name and model description Constructeur et description du modèle Marke und Modell Beschreibung Marca y modelo de descripción	Quote Dimensions Abmessungen Dimensiones 	Piatto Plate Platte Plaque 	Curvatura Curvature Corbure Krummung 	Foro Hole Trou Locher Hoyos Ø (mm)	Interasse Cent. Distance Achsenabstand Distancia entre ejes 	Peso Weight Gewicht Poids
---	--	---	---	---	---	--	--

CELLI

→ 65 ←

ZCEL40	PIONEER 360 P - PF Cod Orig: 722550-51		80 X 10	SQ Elicoidale	14.5	57	1650
--------	--	--	---------	------------------	------	----	------

CMB

ZCMB01	BIETOLA 40		40 X 6	C	10.5	23	230
ZCMB02	BIETOLA 60		40 X 6	C	10.5	23	250
ZCMB03	BIETOLA 80		40 X 6	C	10.5	23	280

COLLARI

ZCLL01	CL 2		80 X 8	C Elicoidale	16.5	46	1230
ZCLL02	B1		80 X 8	SQ Elicoidale	14.5	42	1300

Tutti gli articoli sono di nostra produzione e non originali. Pesi e misure sono puramente indicativi e possono essere modificati senza preavviso. La riproduzione anche parziale del presente catalogo è vietata. All articles are of our production and not original. Weights and measures are approximate and may change without notice. Reproduction of this catalog is prohibited. Tous les articles sont fabriqués par nous-mêmes et non d'origine. Les poids et mesures sont approximatifs et peuvent changer sans préavis. Alle Artikel werden von uns selbst hergestellt und nicht original. Masse und Gewichte sind Richtwerte und können ohne Vorankündigung geändert werden.

Codice Code Ref. Re. Codigo	Marca e descrizione modello Brand name and model description Constructeur et description du modèle Marke und Modell Beschreibung Marca y modelo de descripción	Quote Dimensions Abmessungen Dimensiones 	Piatto Plate Platte Plaque 	Curvatura Curvature Corbure Krummung 	Foro Hole Trou Locher Hoyos Ø (mm)	Interasse Cent. Distance Achsenabstand Distancia entre ejes 	Peso Weight Gewicht Poids 
---	--	--	---	--	---	---	---

COMEB

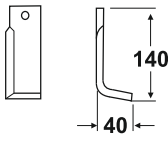
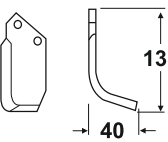
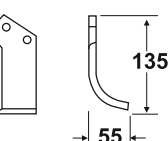
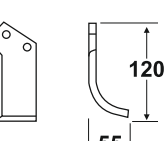
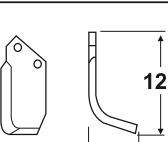
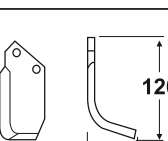
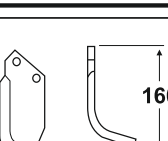
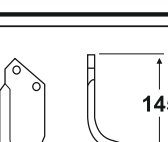
ZCOM01	FL - CI2 1 FORO		35 X 5	SQ	10.5	-	220
ZCOM02	FP - P10		50 X 5	C	10.5	32	290
ZCOM03	FP - CP7 MAIS		50 X 5	C	10.5	32	280
ZCOM04	FP CORTA		50 X 6	SQ	10.5	32	240
ZCOM05	P7 - FP - CP9 BIETOLA		50 X 5	C	10.5	32	300
ZCOM06	FL - FP - CP8 - CP10 BIETOLA CORTA		50 X 5	C	10.5	32	230
ZCOM07	R23		60 X 6	C	12.5	42	530
ZCOM08	CR22 - FPR - FPSR FL - SR		60 X 6	C	12.5	42	440

Tutti gli articoli sono di nostra produzione e non originali. Pesì e misure sono puramente indicativi e possono essere modificati senza preavviso. La riproduzione anche parziale del presente catalogo è vietata. All articles are of our production and not original. Weights and measures are approximate and may change without notice. Reproduction of this catalog is prohibited. Tous les articles sont fabriqués par nous-même mes et non d'origine. Les poids et mesurés sont approximatifs et peuvent changer sans préavis. Alle artikel werden von uns selbst hergestellt und nicht original. Masse und gewichte sind richtwerte und kan ohne vorank undigung gendert werden.





Codice Code Ref. Re. Codigo	Marca e descrizione modello Brand name and model description Constructeur et description du modèle Marke und Modell Beschreibung Marca y modelo de descripción	Quote Dimensions Abmessungen Dimensiones 	Piatto Plate Platte Plaque 	Curvatura Curvature Corbure Krummung 	Foro Hole Trou Locher Hoyos Ø (mm)	Interasse Cent. Distance Achsenabstand Distancia entre ejes 	Peso Weight Gewicht Poids
---	--	---	---	---	---	--	--

COMEB

ZCOM09	CORTA		50 X 6	SQ	10.5	32	400
ZCOM10	LUNGA		50 X 6	SQ	10.5	32	340
ZCOM11	LUNGA		50 X 5	C	10.5	32	340
ZCOM12	INTERRASASSI		90 X 10	-	14.5	57	1200
ZCOM13	INTERRASASSI		90 X 8	-	14.5	57	1240
ZCOM14	INTERRASASSI Cod Orig: F50.01		90 X 10	-	14.5	57	1240

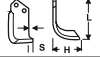
CUCCHI

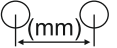
ZCUC01	FRESINO		50 X 8	C	12.5	25	600
--------	---------	--	--------	---	------	----	-----

Codice Code Ref. Re. Codigo	Marca e descrizione modello Brand name and model description Constructeur et description du modèle Marke und Modell Beschreibung Marca y modelo de descripción	Quote Dimensions Abmessungen Dimensiones 	Piatto Plate Platte Plaque 	Curvatura Curvature Corbure Krummung 	Foro Hole Trou Locher Hoyos Ø (mm)	Interasse Cent. Distance Achsenabstand Distancia entre ejes 	Peso Weight Gewicht Poids 
---	--	--	---	--	---	---	---

CUCCHI

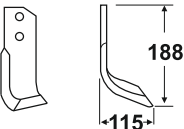
ZCUC02	ZAPPA		70 X 8	C	14.5	34	950
--------	-------	---	--------	---	------	----	-----

DEL MORINO

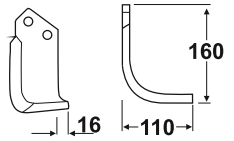
ZDLM01	FRESA HOLIDAY		60 X 6	C Elicoidale	12.5	34	600
--------	---------------	--	--------	-----------------	------	----	-----

DIESE

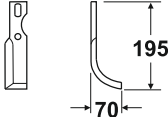
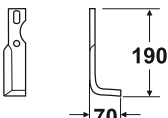
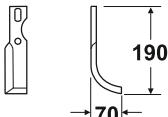
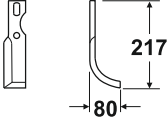
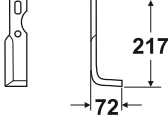
ZDIE01	ZAPPA ASOLA		35 X 5	C	8.5	65 - 73	350
ZDIE02	ZAPPA ASOLA		35 X 6	SQ	8.5	65 - 73	400
ZDIE03	ZAPPA ASOLA		30 X 6	C	8.5	65 - 73	350
ZDIE04	ZAPPA ASOLA		40 X 6	C	10.5	65 - 73	420
ZDIE05	ZAPPA ASOLA		40 X 6	SQ	10.5	65 - 73	420

Codice Code Ref. Re. Codigo	Marca e descrizione modello Brand name and model description Constructeur et description du modèle Marke und Modell Beschreibung Marca y modelo de descripción	Quote Dimensions Abmessungen Dimensiones 	Piatto Plate Platte Plaque 	Curvatura Curvature Corbure Krummung 	Foro Hole Trou Locher Hoyos Ø (mm)	Interasse Cent. Distance Achsenabstand Distancia entre ejes 	Peso Weight Gewicht Poids
---	--	---	---	---	---	--	--



DIESE

ZDIE06	ZAPPA ASOLA		45 X 6	C	10.5	65 - 73	470
ZDIE07	ZAPPA ASOLA		45 X 6	SQ	10.5	65 - 73	470
ZDIE08	ZAPPA ASOLA		50 X 6	C	10.5	65 - 73	550
ZDIE09	ZAPPA ASOLA		50 X 6	SQ	10.5	65 - 73	550

DONDI

ZDON01	BA - DFL Cod Orig: 637001		60 X 6	C	12.5	31	470
ZDON02	M - DM		70 X 6	C Elicoidale	12.5	54	720
ZDON03	F - DCL		70 X 6	C Elicoidale	12.5	40	730

Tutti gli articoli sono di nostra produzione e non originali. Pesi e misure sono puramente indicativi e possono essere modificati senza preavviso. La riproduzione anche parziale del presente catalogo è vietata. All articles are of our production and not original. Weights and measures are approximate and may change without notice. Reproduction of this catalog is prohibited. Tous les articles sont fabriqués par nous-mêmes et non d'origine. Les poids et mesures sont approximatifs et peuvent changer sans préavis. Alle Artikel werden von uns selbst hergestellt und nicht original. Masse und Gewichte sind Richtwerte und können ohne Vorankündigung geändert werden.

Codice Code Ref. Re. Codigo	Marca e descrizione modello Brand name and model description Constructeur et description du modèle Marke und Modell Beschreibung Marca y modelo de descripción	Quote Dimensions Abmessungen Dimensiones 	Piatto Plate Platte Plaque 	Curvatura Curvature Corbure Krummung 	Foro Hole Trou Locher Hoyos Ø (mm) 	Interasse Cent. Distance Achsenabstand Distancia entre ejes 	Peso Weight Gewicht Poids 
---	--	--	---	--	--	---	---

DONDI

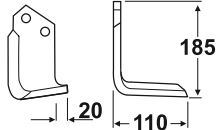
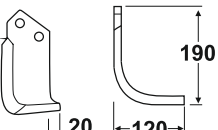
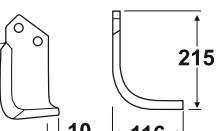
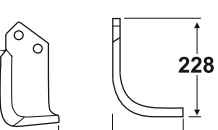
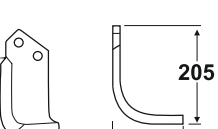
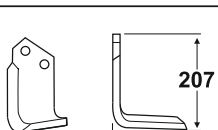
ZDON04	F - DCL - DCLS		70 X 6	SQ Elicoidale	12.5	40	780
ZDON07	O N.T. DCM		70 X 7	C Elicoidale	12.5	40	850
ZDON08	R		80 X 8	C Elicoidale	14.5	54	1220
ZDON09	B1 - N TIPO NUOVO B1		80 X 8	C Elicoidale	14.5	46	1220
ZDON10	A - B		80 X 8	C Elicoidale	14.5	46	1150
ZDON11	A - B 2		80 X 8	SQ Elicoidale	14.5	46	1300

EBERHARDT

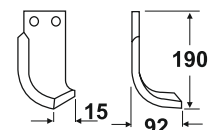
ZEBRO1	RKB 471 Cod Orig: 1570-71		80 X 6	C Elicoidale	14.5	45	800
--------	------------------------------	---	--------	-----------------	------	----	-----

Codice Code Ref. Re. Codigo	Marca e descrizione modello Brand name and model description Constructeur et description du modèle Marke und Modell Beschreibung Marca y modelo de descripción	Quote Dimensions Abmessungen Dimensiones 	Piatto Plate Platte Plaque 	Curvatura Curvature Corbure Krummung 	Foro Hole Trou Locher Hoyos Ø (mm) 	Interasse Cent. Distance Achsenabstand Distancia entre ejes 	Peso Weight Gewicht Poids 
---	--	--	---	--	--	---	---

EBERHARDT

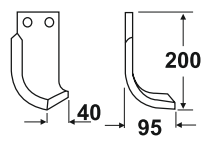
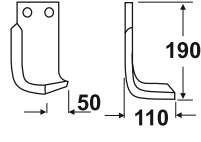
ZEBR02	RKB 471 Cod Orig: 1560-61		80 X 6	C Elicoidale	14.5	45	820
ZEBR03	RKB 471 Cod Orig: 1530-31		80 X 7	SQ Elicoidale	14.5	45	1100

EMY ELENFER

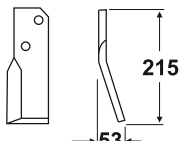
ZEMY01	ZAPPA BAULATRICE		60 X 12	Y	14.5	40	1200
--------	---------------------	---	---------	---	------	----	------

EUROGREEN (EWG)

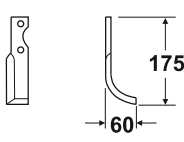
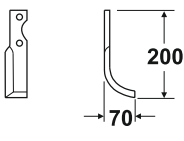
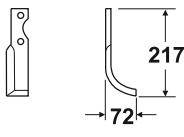
ZEGR01	MOTOZAPPA 531		30 X 5	C	8.5	50	270
ZEGR02	MOTOZAPPA 551		35 X 5	C	8.5	73	350
ZEGR03	MOTOZAPPA 572 - 573 - 583		40 X 6	C	10.5	73	420

Tutti gli articoli sono di nostra produzione e non originali. Pesi e misure sono puramente indicativi e possono essere modificati senza preavviso. La riproduzione anche parziale del presente catalogo è vietata. All articles are of our production and not original. Weights and measures are approximate and may change without notice. Reproduction of this catalog is prohibited. Tous les articles sont fabriqués par nous-mêmes et non d'origine. Les poids et mesures sont approximatifs et peuvent changer sans préavis. Alle Artikel werden von uns selbst hergestellt und nicht original. Masse und Gewichte sind Richtwerte und können ohne Vorankündigung geändert werden.

Codice Code Ref. Re. Codigo	Marca e descrizione modello Brand name and model description Constructeur et description du modèle Marke und Modell Beschreibung Marca y modelo de descripción	Quote Dimensions Abmessungen Dimensiones 	Piatto Plate Platte Plaque 	Curvatura Curvature Corbure Krummung 	Foro Hole Trou Locher Hoyos Ø (mm)	Interasse Cent. Distance Achsenabstand Distancia entre ejes 	Peso Weight Gewicht Poids
---	--	---	---	---	---	--	--

EUROGREEN (EWG)

ZEGR04	MOTZAPPA 572 - 573 - 583		40 X 6	SQ	10.5	73	460
ZEGR05	MOTZAPPA 594		45 X 6	C	10.5	73	500
ZEGR06	MOTZAPPA 594		45 X 6	SQ	10.5	73	510
ZEGR07	MOTZAPPA 584		50 X 6	C	10.5	73	550
ZEGR08	MOTZAPPA 584		50 X 6	SQ	10.5	73	600

EUROSYSTEM



ZEUR01	MTZ EURO 50 S EURO 3 Cod Orig: 260015210-11		30 X 5	C Elicoidale	8.5	65	200
ZEUR02	EURO 5 Cod Orig: F1233102-03		30 X 4	C	8.5	65	180

Codice Code Ref. Re. Codigo	Marca e descrizione modello Brand name and model description Constructeur et description du modèle Marke und Modell Beschreibung Marca y modelo de descripción	Quote Dimensions Abmessungen Dimensiones 	Piatto Plate Platte Plaque 	Curvatura Curvature Corbure Krummung 	Foro Hole Trou Locher Hoyos Ø (mm) 	Interasse Cent. Distance Achsenabstand Distancia entre ejes 	Peso Weight Gewicht Poids 
---	--	--	---	--	--	---	---

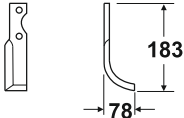
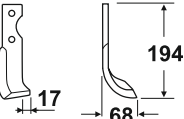
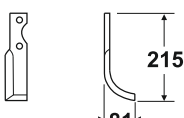
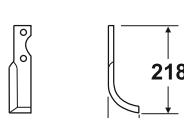

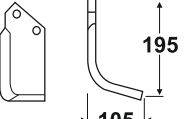
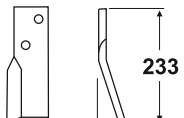

EUROSYSTEM

ZEUR03	P 75		25 X 5	C	10.5	65	190
ZEUR04	EURO 6		35 X 5	C Elicoidale	8.5	73	260
ZEUR06	EURO 102 - MTZ 34F Cod Orig: 15206-07		40 X 6	C	10.5	73	400
ZEUR08	EURO 140		50 X 6	C	10.5	73	550

FALC

ZFAL01	B 207 Cod Orig: 1010123090-100		60 X 6	C	12.5	42	500
ZFAL02	COLTELLO TERRA KING		60 X 12	-	14.5	44	1250
ZFAL03	INTERFILARE 302 - 303		80 X 7	C Elicoidale	14.5	57	1020

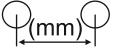
Tutti gli articoli sono di nostra produzione e non originali. Pesi e misure sono puramente indicativi e possono essere modificati senza preavviso. La riproduzione anche parziale del presente catalogo è vietata. All articles are of our production and not original. Weights and measures are approximate and may change without notice. Reproduction of this catalog is prohibited. Tous les articles sont fabriqués par nous-mêmes et non d'origine. Les poids et mesures sont approximatifs et peuvent changer sans préavis. Alle Artikel werden von uns selbst hergestellt und nicht original. Masse und Gewichte sind Richtwerte und können ohne Vorankündigung geändert werden.

Codice Code Ref. Re. Codigo	Marca e descrizione modello Brand name and model description Constructeur et description du modèle Marke und Modell Beschreibung Marca y modelo de descripción	Quote Dimensions Abmessungen Dimensiones 	Piatto Plate Platte Plaque 	Curvatura Curvature Corbure Krummung 	Foro Hole Trou Locher Hoyos Ø (mm)	Interasse Cent. Distance Achsenabstand Distancia entre ejes 	Peso Weight Gewicht Poids 
---	--	--	---	--	---	---	---

FALC

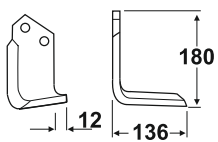
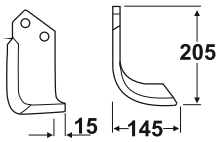
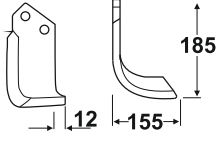
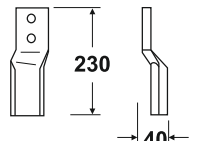
ZFAL04	FRESA 235		80 X 7	SQ	14.5	57	1050
ZFAL06	ZAPPA Cod Orig: 2503026-27		105 X 8	C	16.5	75	2000
ZFAL07	MALTA		80 X 7	C Elicoidale	14.5	57	1100
ZFAL09	COLTELLO		60 X 12	D	16.5	50	1200

FALCONERO

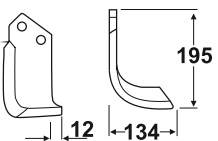
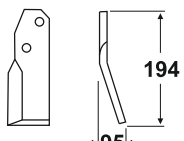

ZFLN01	MANTA		80 X 7	C Elicoidale	14.5	57	980
ZFLN02	SCORPIO		60 X 10	-	16.5	35	980

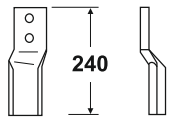
FERABOLI



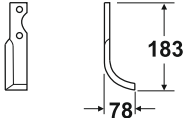
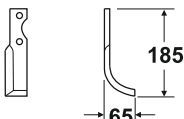
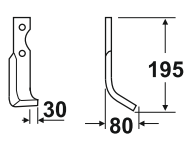
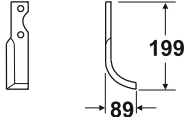
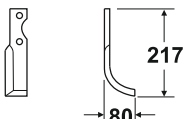
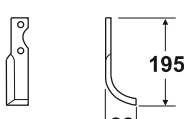
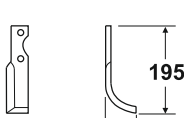

ZFEB01	COLTELLO		50 X 12	D	16.5	40	1050
--------	----------	---	---------	---	------	----	------

Codice Code Ref. Re. Codigo	Marca e descrizione modello Brand name and model description Constructeur et description du modèle Marke und Modell Beschreibung Marca y modelo de descripción	Quote Dimensions Abmessungen Dimensiones 	Piatto Plate Platte Plaque 	Curvatura Curvature Corbure Krummung 	Foro Hole Trou Locher Hoyos Ø (mm)	Interasse Cent. Distance Achsenabstand Distancia entre ejes 	Peso Weight Gewicht Poids 
---	--	--	---	--	---	---	---

FERRARI

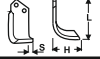
ZFER01	TIPO 300		25 X 5	C	10.5	65	190
ZFER02	TIPO 32 - F		30 X 5	C	8.5	73	230
ZFER03	71 - 90		30 X 6	C Elicoidale	10.5	66	300
ZFER04	307 LEGGERA		30 X 6	C	10.5	65	300
ZFER05	34		30 X 6	C	10.5	73	300
ZFER06	91 - 92		35 X 6	C	10.5	65	350
ZFER07	92 MAGGIORATA		40 X 6	C	10.5	65	350
ZFER08	34		40 X 6	C	10.5	73	440

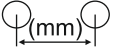
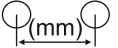

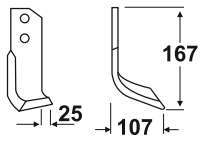
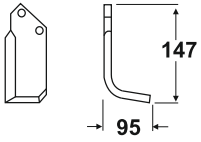
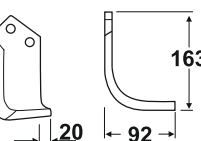
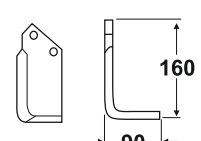
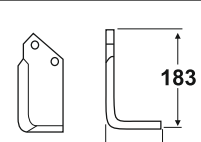
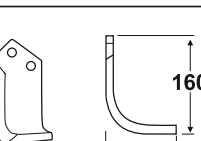
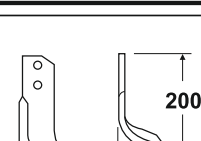
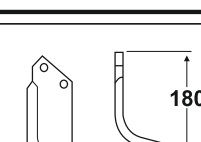

Tutti gli articoli sono di nostra produzione e non originali. Pesì e misure sono puramente indicativi e possono essere modificati senza preavviso. La riproduzione anche parziale del presente catalogo è vietata. All articles are of our production and not original. Weights and measures are approximate and may change without notice. Reproduction of this catalog is prohibited. Tous les articles sont fabriqués par nous-mêmes et non d'origine. Les poids et mesures sont approximatifs et peuvent changer sans préavis. Alle Artikel werden von uns selbst hergestellt und nicht original. Masse und Gewichte sind Richtwerte und können ohne Vorankündigung geändert werden.

Codice Code Ref. Re. Codigo	Marca e descrizione modello Brand name and model description Constructeur et description du modèle Marke und Modell Beschreibung Marca y modelo de descripción	Quote Dimensions Abmessungen Dimensiones 	Piatto Plate Platte Plaque 	Curvatura Curvature Corbure Krummung 	Foro Hole Trou Locher Hoyos Ø (mm) 	Interasse Cent. Distance Achsenabstand Distancia entre ejes 	Peso Weight Gewicht Poids 
---	--	--	---	--	--	---	---

FERRARI

ZFER09	MC 58 ROMAGNA TIPO VECCHIO		40 X 8	C Elicoidale	12.5	33	480
ZFER10	MC 68 - 72 SUPER TIPO VECCHIO		45 X 6	C	10.5	25	380
ZFER11	72 SUPER		50 X 6	C Elicoidale	10.5	25	430
ZFER12	72 SUPER		50 X 6	SQ	10.5	25	450
ZFER13	TIPO CALABRIA		50 X 6	SQ	10.5	25	460
ZFER14	UNIFICATO TIPO NUOVO		50 X 8	C	12.5	25	580
ZFER15	MC 58 - 60 ROMAGNA		50 X 8	C	12.5	33	700
ZFER16	MC 60 - 68		60 X 6	C	12.5	25	550

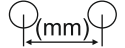

Tutti gli articoli sono di nostra produzione e non originali. Pesì e misure sono puramente indicativi e possono essere modificati senza preavviso. La riproduzione anche parziale del presente catalogo è vietata. All articles are of our production and not original. Weights and measures are approximate and may change without notice. Reproduction of this catalog is prohibited. Tous les articles sont fabriqués par nous-mêmes et non d'origine. Les poids et mesurent approximatifs et peuvent changer sans préavis. Alle artikel werden von uns selbst hergestellt und nicht original. Masse und gewichte sind richtwerte und kan ohne vorank undigung gendert werden.

Codice Code Ref. Re. Codigo	Marca e descrizione modello Brand name and model description Constructeur et description du modèle Marke und Modell Beschreibung Marca y modelo de descripción	Quote Dimensions Abmessungen Dimensiones 	Piatto Plate Platte Plaque 	Curvatura Curvature Corbure Krummung 	Foro Hole Trou Locher Hoyos Ø (mm)	Interasse Cent. Distance Achsenabstand Distancia entre ejes 	Peso Weight Gewicht Poids 
---	--	--	---	--	---	---	---

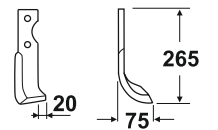
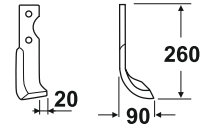
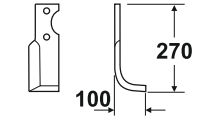
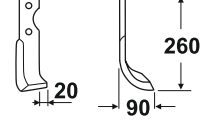
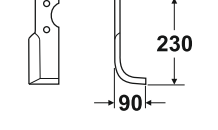
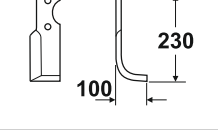
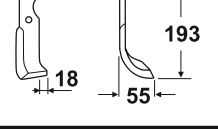
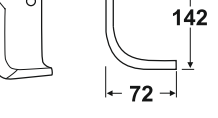
FERRARI

ZFER17	74 - 75 CORTA		60 X 6	C	12.5	90	800
ZFER18	74 - 75 LUNGA		60 X 6	C	12.5	90	850
ZFER19	74 - 75 LUNGA		60 X 6	SQ	12.5	90	830
ZFER21	74 - 75 LUNGA		60 X 7	C	12.5	90	925
ZFER22	74 - 75 LUNGA		60 X 7	SQ	12.5	90	950
ZFER23	74 - 75 MAGGIORATA		70 X 7	SQ	12.5	90	1000
ZFER24	320 - 330 - 340		30 X 6	C Elicoidale	8.5	55	270
ZFER25	72 TIPO NUOVO		50 X 6	C	10.5	25	360

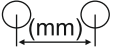
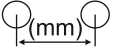
Tutti gli articoli sono di nostra produzione e non originali. Pesì e misure sono puramente indicativi e possono essere modificati senza preavviso. La riproduzione anche parziale del presente catalogo è vietata. All articles are of our production and not original. Weights and measures are approximate and may change without notice. Reproduction of this catalog is prohibited. Tous les articles sont fabriqués par nous-mêmes et non d'origine. Les poids et mesurent approximatifs et peuvent changer sans préavis. Alle artikel werden von uns selbst hergestellt und nicht original. Masse und gewichte sind richtwerte und kan ohne vorank undigung gendert werden.

Codice Code Ref. Re. Codigo	Marca e descrizione modello Brand name and model description Constructeur et description du modèle Marke und Modell Beschreibung Marca y modelo de descripción	Quote Dimensions Abmessungen Dimensiones 	Piatto Plate Platte Plaque 	Curvatura Curvature Corbure Krummung 	Foro Hole Trou Locher Hoyos Ø (mm) 	Interasse Cent. Distance Achsenabstand Distancia entre ejes 	Peso Weight Gewicht Poids 
---	--	--	---	--	--	---	---

FERRARI

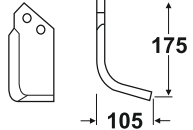
ZFER26	TIPO VECCHIO		50 X 6	C	12.5	25	450
--------	--------------	---	--------	---	------	----	-----

FERRI

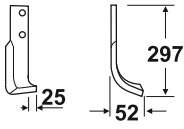
ZFEI01	INTERFILARE		40 X 8	C Elicoidale	11.5	42	500
--------	-------------	---	--------	-----------------	------	----	-----

FM MATRAS

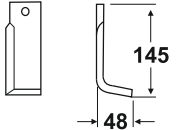
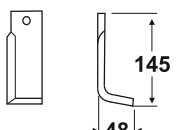
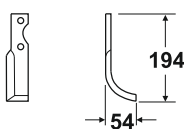
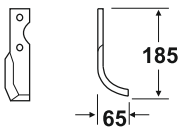
ZFMM01	D7 - C4		25 X 5	SQ	8.5	-	160
ZFMM02	D7 TIPO NUOVO Cod Orig: 9020008		30 X 5	SQ	8.5	-	190
ZFMM03	ALLY Cod Orig: 2620008-09		30 X 4	C	8.5	65	260
ZFMM04	MT 10 NT 820 EXPORT ES		40 X 5	SQ	10.5	80	370

Codice Code Ref. Re. Codigo	Marca e descrizione modello Brand name and model description Constructeur et description du modèle Marke und Modell Beschreibung Marca y modelo de descripción	Quote Dimensions Abmessungen Dimensiones 	Piatto Plate Platte Plaque 	Curvatura Curvature Corbure Krummung 	Foro Hole Trou Locher Hoyos Ø (mm) 	Interasse Cent. Distance Achsenabstand Distancia entre ejes 	Peso Weight Gewicht Poids 
---	--	--	---	--	--	---	---

FM MATRAS

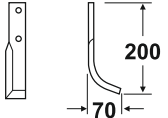
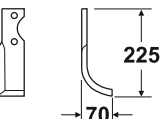
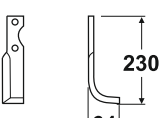
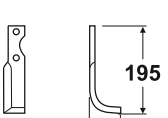
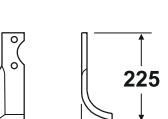
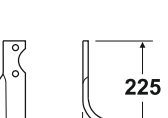
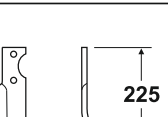
ZFMM05	S 430 - 440 Cod Orig: 7030003-08		40 X 5	C	10.5	80	370
ZFMM07	R5 - R100		40 X 6	C	10.5	80	460
ZFMM08	R5 - R100		45 X 6	SQ	10.5	80	480
ZFMM09	MY 10 - R5		45 X 6	SQ	10.5	80	420
ZFMM10	R5 - 450 Cod Orig: 5020003-04		45 X 6	C	10.5	80	540
ZFMM11	R4 - R95 Cod Orig: 4020006-07		50 X 6	C	10.5	80	580
ZFMM12	R4 - R95		50 X 6	SQ	10.5	80	600

Codice Code Ref. Re. Codigo	Marca e descrizione modello Brand name and model description Constructeur et description du modèle Marke und Modell Beschreibung Marca y modelo de descripción	Quote Dimensions Abmessungen Dimensiones 	Piatto Plate Platte Plaque 	Curvatura Curvature Corbure Krummung 	Foro Hole Trou Locher Hoyos Ø (mm)	Interasse Cent. Distance Achsenabstand Distancia entre ejes 	Peso Weight Gewicht Poids
---	--	---	---	---	---	--	--

FORIGO

ZFOR01	FRESA F2 Cod Orig: F2095010		70 X 7	C Elicoidale	12.5	46	730
ZFOR02	FRESA G25		70 X 7	SQ Elicoidale	12.5	46	750
ZFOR03	FRESA F3 Cod Orig: F3156110-010		80 X 8	C Elicoidale	14.5	46	930
ZFOR04	FRESA G35		80 X 7	C Elicoidale	14.5	48	990
ZFOR05	FRESA F1 Cod Orig: 1060010		60 X 6	C Elicoidale	12.5	42	600
ZFOR06	AIUOLATRICE D35 Cod Orig: D350010020-30		40 X 8	SSQ	12.5	105	630
ZFOR07	AIUOLATRICE D45 Cod Orig: D450010020-30		50 X 12	SSQ	14.5	115	1400
ZFOR08	AIUOLATRICE D45 ASOLA Cod Orig: D350010350-60		50 X 10	SSQ	12.5	105 - 115	1200



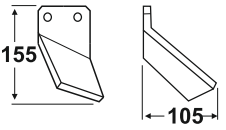
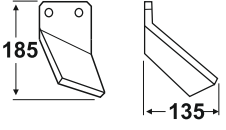
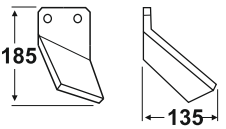
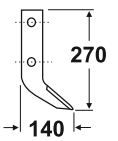
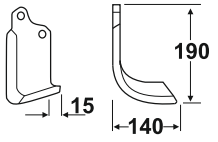
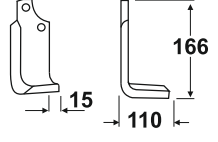
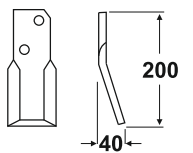
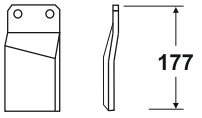

Tutti gli articoli sono di nostra produzione e non originali. Pesi e misure sono puramente indicativi e possono essere modificati senza preavviso. La riproduzione anche parziale del presente catalogo è vietata. All articles are of our production and not original. Weights and measures are approximate and may change without notice. Reproduction of this catalog is prohibited. Tous les articles sont fabriqués par nous-mêmes et non d'origine. Les poids et mesurent approximatifs et peuvent changer sans préavis. Alle artikel werden von uns selbst hergestellt und nicht original. Masse und gewichte sind richtwerte und kan ohne vorank undigung gendert werden.

Codice Code Ref. Re. Codigo	Marca e descrizione modello Brand name and model description Constructeur et description du modèle Marke und Modell Beschreibung Marca y modelo de descripción	Quote Dimensions Abmessungen Dimensiones 	Piatto Plate Platte Plaque 	Curvatura Curvature Corbure Krummung 	Foro Hole Trou Locher Hoyos Ø (mm) 	Interasse Cent. Distance Achsenabstand Distancia entre ejes 	Peso Weight Gewicht Poids 
---	--	--	---	--	--	---	---

FORIGO

ZFOR09	INTERRASASSI G25 Cod Orig: G2596010-11		80 X 7	-	12.5	46	790
ZFOR10	INTERRASASSI G35 Cod Orig: G3596010-11		90 X 8	-	14.5	48	1180
ZFOR11	INTERRASASSI G45 Cod Orig: G4595000-100		100 X 8	-	14.5	56	1280
ZFOR12	SAGOMATORE PATATE RIPORTO ANTIUSURA		40 X 10	-	12.5	75	900
ZFOR13	FRESA F4 Cod Orig: 4151010-110		80 X 8	C Elicoidale	14.5	56	1150
ZFOR14	FRESA G15		60 X 6	SQ Elicoidale	12.5	42	630
ZFOR15	FRANGOR		60 X 12	Y	16.5	50	1110
ZFOR16	COLTELLO G 35		100 X 8	D	14.5	48	1050

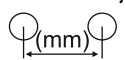
Tutti gli articoli sono di nostra produzione e non originali. Pesi e misure sono puramente indicativi e possono essere modificati senza preavviso. La riproduzione anche parziale del presente catalogo è vietata. All articles are of our production and not original. Weights and measures are approximate and may change without notice. Reproduction of this catalog is prohibited. Tous les articles sont fabriqués par nous-mêmes et non d'origine. Les poids et mesures sont approximatifs et peuvent changer sans préavis. Alle Artikel werden von uns selbst hergestellt und nicht original. Masse und Gewichte sind Richtwerte und können ohne Vorankündigung geändert werden.

Codice Code Ref. Re. Codigo	Marca e descrizione modello Brand name and model description Constructeur et description du modèle Marke und Modell Beschreibung Marca y modelo de descripción	Quote Dimensions Abmessungen Dimensiones 	Piatto Plate Platte Plaque 	Curvatura Curvature Corbure Krummung 	Foro Hole Trou Locher Hoyos Ø (mm)	Interasse Cent. Distance Achsenabstand Distancia entre ejes 	Peso Weight Gewicht Poids 
---	--	--	---	--	---	---	---

FORIGO

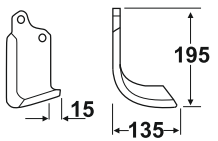
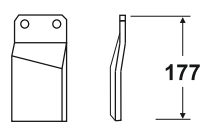
ZFOR17	FRESA G 35		80 X 7	C Elicoidale	14.5	48	1030
ZFOR18	COLTELLO G 45		100 X 8	D	14.5	56	1100

FORT

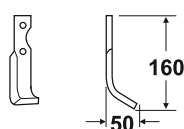
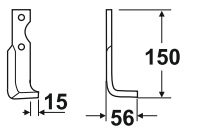
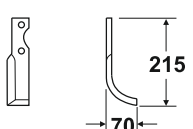
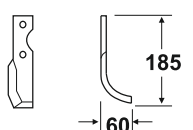
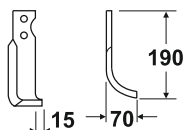
ZFOT01	PRIMULA GARDEN		30 X 5	C	8.5	70	190
ZFOT02	PRIMULA GARDEN		30 X 5	SQ Elicoidale	8.5	70	210
ZFOT03	SCARABEO FS3 MINITIGRE BENZINA		40 X 5	C	8.5	70	350
ZFOT04	FORAGGERA FM B2 - S180		40 X 5	C	8.5	70	300
ZFOT05	CENTAURO FM 90		45 X 5	C Elicoidale	10.5	34	380

Tutti gli articoli sono di nostra produzione e non originali. Pesi e misure sono puramente indicativi e possono essere modificati senza preavviso. La riproduzione anche parziale del presente catalogo è vietata. All articles are of our production and not original. Weights and measures are approximate and may change without notice. Reproduction of this catalog is prohibited. Tous les articles sont fabriqués par nous-mêmes et non d'origine. Les poids et mesures sont approximatifs et peuvent changer sans préavis. Alle Artikel werden von uns selbst hergestellt und nicht original. Masse und Gewichte sind Richtwerte und können ohne Vorankündigung geändert werden.

Codice Code Ref. Re. Codigo	Marca e descrizione modello Brand name and model description Constructeur et description du modèle Marke und Modell Beschreibung Marca y modelo de descripción	Quote Dimensions Abmessungen Dimensiones 	Piatto Plate Platte Plaque 	Curvatura Curvature Corbure Krummung 	Foro Hole Trou Locher Hoyos Ø (mm)	Interasse Cent. Distance Achsenabstand Distancia entre ejes 	Peso Weight Gewicht Poids
---	--	---	---	---	---	--	--



FORT

ZFOT06	JOLLY SERIE 180 MINITIGRE BENZINA Cod Orig: 15715012-13		40 X 5	SSQ	8.5	70	500
ZFOT07	MINITIGRE DIESEL Cod Orig: 15715113-14		40 X 6	C	10.5	70	450
ZFOT08	TIGROTTO FT3		45 X 6	C	10.5	65	520
ZFOT09	TIGROTTO FT4 INTERNA		45 X 6	C Elicoidale	10.5	65	450
ZFOT10	LEONE FL4 INTERNA		45 X 6	C Elicoidale	10.5	75	450
ZFOT11	LEONE FL3		45 X 6	C	10.5	75	480
ZFOT12	LEONE		45 X 6	SQ	10.5	75	500
ZFOT13	UNIVERSALE		50 X 6	C	10.5	65	580

Tutti gli articoli sono di nostra produzione e non originali. Pesi e misure sono puramente indicativi e possono essere modificati senza preavviso. La riproduzione anche parziale del presente catalogo è vietata. All articles are of our production and not original. Weights and measures are approximate and may change without notice. Reproduction of this catalog is prohibited. Tous les articles sont fabriqués par nous-même et non d'origine. Les poids et mesurés sont approximatifs et peuvent changer sans préavis. Alle artikel werden von uns selbst hergestellt und nicht original. Masse und gewichte sind richtwerte und kan ohne vorank undigung gendert werden.

Codice Code Ref. Re. Codigo	Marca e descrizione modello Brand name and model description Constructeur et description du modèle Marke und Modell Beschreibung Marca y modelo de descripción	Quote Dimensions Abmessungen Dimensiones 	Piatto Plate Platte Plaque 	Curvatura Curvature Corbure Krummung 	Foro Hole Trou Locher Hoyos Ø (mm) 	Interasse Cent. Distance Achsenabstand Distancia entre ejes 	Peso Weight Gewicht Poids 
---	--	--	---	--	--	---	---

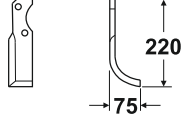
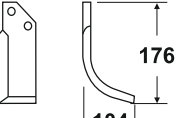
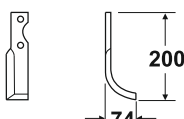
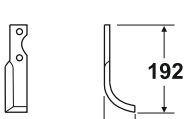
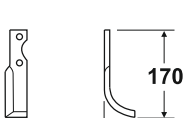
FORT

ZFOT14	TIPO TERRANOVA		50 X 6	C	10.5	75	550
ZFOT15	CORSARO F - 700		60 X 6	C	10.5	42	600
ZFOT20	MINITIGRE Cod Orig: 15055077-78		40 X 5	C	10.5	70	320
ZFOT21	MICRO 1 - 2 - 3 MTC 280 - 150 Cod Orig: 15485068		35 X 5	C	8.5	70	280
ZFOT22	S 280		35 X 5	C	8.5	70	260
ZFOT24	MINITIGRE ELICA		40 X 4	C Elicoidale	8.5	70	270

GASPARDO

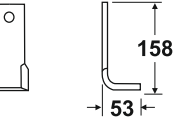
ZGAS01	COLTELLO 1 FORO		50 X 6	SQ	13.5	-	450
--------	--------------------	---	--------	----	------	---	-----

Tutti gli articoli sono di nostra produzione e non originali. Pesi e misure sono puramente indicativi e possono essere modificati senza preavviso. La riproduzione anche parziale del presente catalogo è vietata. All articles are of our production and not original. Weights and measures are approximate and may change without notice. Reproduction of this catalog is prohibited. Tous les articles sont fabriqués par nous-mêmes et non d'origine. Les poids et mesures sont approximatifs et peuvent changer sans préavis. Alle artikel werden von uns selbst hergestellt und nicht original. Masse und gewichte sind richtwerte und kan ohne vorank undigung gendert werden.

Codice Code Ref. Re. Codigo	Marca e descrizione modello Brand name and model description Constructeur et description du modèle Marke und Modell Beschreibung Marca y modelo de descripción	Quote Dimensions Abmessungen Dimensiones 	Piatto Plate Platte Plaque 	Curvatura Curvature Corbure Krummung 	Foro Hole Trou Locher Hoyos Ø (mm)	Interasse Cent. Distance Achsenabstand Distancia entre ejes 	Peso Weight Gewicht Poids
---	--	---	---	---	---	--	--

GOLDONI

ZGOL01	MINOR BIETOLE F26 - 24		35 X 6	C	8.5	70	290
ZGOL02	SPECIAL FRESA 22 - 23 ASOLA Cod Orig: 2070-71		35 X 6	C	8.5	30 - 33	330
ZGOL03	FRESA 25 EXPORT Cod Orig: 2064-65		35 X 8	C	8.5	30	430
ZGOL06	FRESA 19 - 21 TIPO 1 - G Cod Orig: 14191-92		40 X 6	SQ	10.5	70	370
ZGOL07	FRESA 21 MONDIAL TIPO VECCHIO Cod Orig: 2692-93		40 X 6	SQ Elicoidale	10.5	80	400
ZGOL08	FRESA 22 SPECIAL Cod Orig: 9401-02		45 X 5	C	10.5	33	390
ZGOL10	FRESA 21 MONDIAL Cod Orig: 8833-34		45 X 5	SSQ	10.5	80	500
ZGOL11	FRESA 22M TIPO NUOVO (TIPO PISTOIA) Cod Orig: 14486-87		45 X 5	C Elicoidale	10.5	42	370

Codice Code Ref. Re. Codigo	Marca e descrizione modello Brand name and model description Constructeur et description du modèle Marke und Modell Beschreibung Marca y modelo de descripción	Quote Dimensions Abmessungen Dimensiones 	Piatto Plate Platte Plaque 	Curvatura Curvature Corbure Krummung 	Foro Hole Trou Locher Hoyos Ø (mm)	Interasse Cent. Distance Achsenabstand Distancia entre ejes 	Peso Weight Gewicht Poids
---	--	---	---	---	---	--	--

GOLDONI





ZGOL12	FRESA 22 SPECIAL		45 X 6	SQ	10.5	33	500
ZGOL13	FRESA 21 M S 600 Cod Orig: 13545-46		50 X 5	C	10.5	39	330
ZGOL14	FRESA 50B BASE 20		50 X 6	C Elicoidale	12.5	46	590
ZGOL15	SUPER - EXPORT F28 Cod Orig: 434-5		60 X 6	C	10.5	99	800
ZGOL16	SUPER - EXPORT F28		60 X 6	SQ	10.5	99	820
ZGOL17	FRESA 50 - 29 ASOLA MOD. 719 Cod Orig: 9417-18		60 X 6	C Elicoidale	12.5	42 - 46	640
ZGOL18	FRESA 50 - 29 ASOLA		60 X 6	SQ	12.5	42 - 46	660
ZGOL19	FRESA 29 Cod Orig: 5323-24		60 X 6	C	10.5	42	600

Codice Code Ref. Re. Codigo	Marca e descrizione modello Brand name and model description Constructeur et description du modèle Marke und Modell Beschreibung Marca y modelo de descripción	Quote Dimensions Abmessungen Dimensiones 	Piatto Plate Platte Plaque 	Curvatura Curvature Corbure Krummung 	Foro Hole Trou Locher Hoyos Ø (mm)	Interasse Cent. Distance Achsenabstand Distancia entre ejes 	Peso Weight Gewicht Poids
---	--	---	---	---	---	--	--

GOLDONI

ZGOL20	FRESA 60 Cod Orig: 20136-37		60 X 6	C Elicoidale	12.5	54	630
ZGOL21	FRESA 60		60 X 6	SQ	12.5	54	650
ZGOL22	FRESA 22 M Cod Orig: 4312-16		60 X 6	C Elicoidale	10.5	42	550
ZGOL23	FRESA 22 M		60 X 6	SQ	10.5	42	600
ZGOL24	FRESA 28 EXPORT 518 Cod Orig: 3935-36		60 X 6	C	12.5	99	700
ZGOL25	FRESA 28 EXPORT 518		60 X 6	SQ	12.5	99	730
ZGOL26	FRESA 40 F27 - 28 UNIVERSAL Cod Orig: 9506-07		70 X 6	C Elicoidale	12.5	54	730
ZGOL27	FRESA 40 F27 - 28 UNIVERSAL		70 X 6	SQ	12.5	54	750

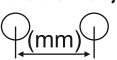
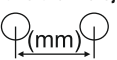
Tutti gli articoli sono di nostra produzione e non originali. Pesi e misure sono puramente indicativi e possono essere modificati senza preavviso. La riproduzione anche parziale del presente catalogo è vietata. All articles are of our production and not original. Weights and measures are approximate and may change without notice. Reproduction of this catalog is prohibited. Tous les articles sont fabriqués par nous-mêmes et non d'origine. Les poids et mesures sont approximatifs et peuvent changer sans préavis. Alle Artikel werden von uns selbst hergestellt und nicht original. Masse und Gewichte sind Richtwerte und können ohne Vorankündigung geändert werden.

Codice Code Ref. Re. Codigo	Marca e descrizione modello Brand name and model description Constructeur et description du modèle Marke und Modell Beschreibung Marca y modelo de descripción	Quote Dimensions Abmessungen Dimensiones 	Piatto Plate Platte Plaque 	Curvatura Curvature Corbure Krummung 	Foro Hole Trou Locher Hoyos Ø (mm) 	Interasse Cent. Distance Achsenabstand Distancia entre ejes 	Peso Weight Gewicht Poids 
---	--	--	---	--	--	---	---

GOLDONI

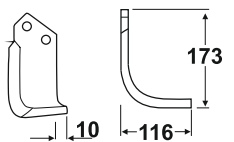
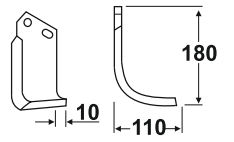
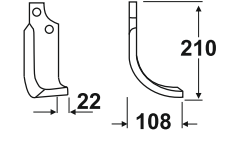
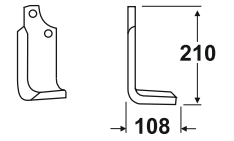
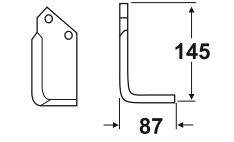
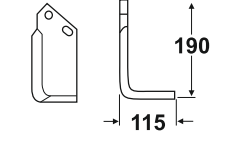
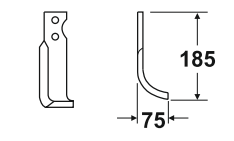
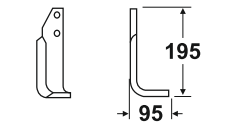
ZGOL28	FRESA 80 - 130 Cod Orig: 17011-12		70 X 6	C Elicoidale	12.5	40	750
ZGOL29	FRESA 50 MAGGIORATA		70 X 6	C Elicoidale	12.5	42 - 46	800
ZGOL31	FRESA 60 MAGGIORATA		70 X 6	C	12.5	54	750
ZGOL32	FRESA 60 MAGGIORATA		70 X 6	SQ	12.5	54	800
ZGOL33	FRESA 21 M ANGOLATA		50 X 6	SQ	10.5	39	400
ZGOL40	FRESA 50 MAGGIORATA		70 X 6	SQ	12.5	42 - 46	800
ZGOL41	FRESA F23 Cod Orig: 224446469-70		35 X 6	C Elicoidale	8.5	33	310
ZGOL42	FRESA 22 M ANGOLATA TIPO NUOVO		45 X 5	SQ	10.5	42	400

Tutti gli articoli sono di nostra produzione e non originali. Pesi e misure sono puramente indicativi e possono essere modificati senza preavviso. La riproduzione anche parziale del presente catalogo è vietata. All articles are of our production and not original. Weights and measures are approximate and may change without notice. Reproduction of this catalog is prohibited. Tous les articles sont fabriqués par nous-mêmes et non d'origine. Les poids et mesures sont approximatifs et peuvent changer sans préavis. Alle Artikel werden von uns selbst hergestellt und nicht original. Masse und Gewichte sind Richtwerte und können ohne Vorankündigung geändert werden.

Codice Code Ref. Re. Codigo	Marca e descrizione modello Brand name and model description Constructeur et description du modèle Marke und Modell Beschreibung Marca y modelo de descripción	Quote Dimensions Abmessungen Dimensiones 	Piatto Plate Platte Plaque 	Curvatura Curvature Corbure Krummung 	Foro Hole Trou Locher Hoyos Ø (mm) 	Interasse Cent. Distance Achsenabstand Distancia entre ejes 	Peso Weight Gewicht Poids 
---	--	--	---	--	--	---	---

GRAMEGNA

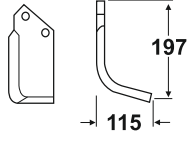
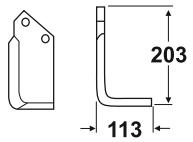
ZGRA01	FRESA		80 X 8	C	12.5	55	1070
ZGRA02	FRESA		80 X 8	SQ	12.5	55	1200

GRILLO

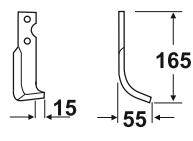
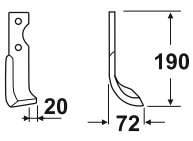
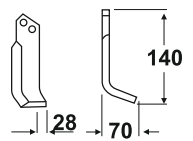
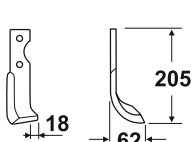
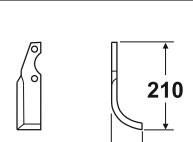
ZGRI01	GRILLETINO B4		25 X 6	C Elicoidale	8.5	55	200
ZGRI02	GN10 - 132 - 85 STANDARD 131 Cod Orig: 7085-86		30 X 6	C Elicoidale	10.5	66	290
ZGRI04	CASTELGUELFO Cod Orig: 7087-88		35 X 6	C Elicoidale	8.5	21	220
ZGRI05	MOTOZAPPA 11500 - 3500 2500 - V2 Cod Orig: 11293-94		35 X 6	C Elicoidale	10.5	66	340
ZGRI06	MOTOZAPPA 11000 - 12000 Cod Orig: 21385-86		40 X 6	C	10.5	66	400

Tutti gli articoli sono di nostra produzione e non originali. Pesi e misure sono puramente indicativi e possono essere modificati senza preavviso. La riproduzione anche parziale del presente catalogo è vietata. All articles are of our production and not original. Weights and measures are approximate and may change without notice. Reproduction of this catalog is prohibited. Tous les articles sont fabriqués par nous-mêmes et non d'origine. Les poids et mesurent approximatifs et peuvent changer sans préavis. Alle artikel werden von uns selbst hergestellt und nicht original. Masse und gewichte sind richtwerte und kan ohne vorank undigung gendert werden.

Codice Code Ref. Re. Codigo	Marca e descrizione modello Brand name and model description Constructeur et description du modèle Marke und Modell Beschreibung Marca y modelo de descripción	Quote Dimensions Abmessungen Dimensiones 	Piatto Plate Platte Plaque 	Curvatura Curvature Corbure Krummung 	Foro Hole Trou Locher Hoyos Ø (mm)	Interasse Cent. Distance Achsenabstand Distancia entre ejes 	Peso Weight Gewicht Poids
---	--	---	---	---	---	--	--

GRILLO

ZGRI07	MOTAZAPPA 9000 - 9000R Cod Orig: 9254		45 X 6	C	10.5	76	470
ZGRI08	GRILLINO PATERNO' 131 Cod Orig: 7635-36		50 X 6	C Elicoidale	10.5	40	370
ZGRI09	GRILLINO PATERNO' 131		50 X 6	SQ	10.5	40	370
ZGRI10	MINI SUPER MINI		30 X 4	C Elicoidale	8.5	50	200
ZGRI11	GNS 15 GN 5 PUGLIA		50 X 8	C Elicoidale	12.5	34	580
ZGRI12	125 D - 126 D - 127 D Cod Orig: 10203-04		30 X 6	C	8.5	55	280
ZGRI13	GRILLINO 126 - 127 4 ZAPPE Cod Orig: 10569-70		30 X 6	C Elicoidale	8.5	55	260
ZGRI14	GRILLINO 126 - 127 Cod Orig: 36667-68		30 X 6	SQ	8.5	55	300

Tutti gli articoli sono di nostra produzione e non originali. Pesi e misure sono puramente indicativi e possono essere modificati senza preavviso. La riproduzione anche parziale del presente catalogo è vietata. All articles are of our production and not original. Weights and measures are approximate and may change without notice. Reproduction of this catalog is prohibited. Tous les articles sont fabriqués par nous-mêmes et non d'origine. Les poids et mesurent approximatifs et peuvent changer sans préavis. Alle artikel werden von uns selbst hergestellt und nicht original. Masse und gewichte sind richtwerte und kan ohne vorank undigung gendert werden.

Codice Code Ref. Re. Codigo	Marca e descrizione modello Brand name and model description Constructeur et description du modèle Marke und Modell Beschreibung Marca y modelo de descripción	Quote Dimensions Abmessungen Dimensiones 	Piatto Plate Platte Plaque 	Curvatura Curvature Corbure Krummung 	Foro Hole Trou Locher Hoyos Ø (mm) 	Interasse Cent. Distance Achsenabstand Distancia entre ejes 	Peso Weight Gewicht Poids
---	--	---	---	---	---	--	--

GRILLO

ZGRI15	MOTAZAPPA 11000 - 12000 Cipro Cod Orig: 21418-19		40 X 6	SQ	10.5	66	400
ZGRI16	MTZ G42 Cod Orig: 48170-171		35 X 6	C Elicoidale	8.5	68	350
ZGRI18	PX Cod Orig: 28311-12		30 X 4	C	8.5	55	190
ZGRI19	PRINCESS Cod Orig: 39011-12		30 X 4	C	8.5	68	210
ZGRI23	PRINCESS PESANTE Cod Orig: 39432-33		40 X 5	C	8.5	68	380
ZGRI24	GRILLETTINO Cod Orig: 7743		30 X 5	C Elicoidale	8.5	66	180

Tutti gli articoli sono di nostra produzione e non originali. Pesi e misure sono puramente indicativi e possono essere modificati senza preavviso. La riproduzione anche parziale del presente catalogo è vietata. All articles are of our production and not original. Weights and measures are approximate and may change without notice. Reproduction of this catalog is prohibited. Tous les articles sont fabriqués par nous-même et non d'origine. Les poids et mesurés sont approximatifs et peuvent changer sans préavis. Alle artikel werden von uns selbst hergestellt und nicht original. Masse und gewichte sind richtwerte und kan ohne vorank undigung gendert werden.

Codice Code Ref. Re. Codigo	Marca e descrizione modello Brand name and model description Constructeur et description du modèle Marke und Modell Beschreibung Marca y modelo de descripción	Quote Dimensions Abmessungen Dimensiones 	Piatto Plate Platte Plaque 	Curvatura Curvature Corbure Krummung 	Foro Hole Trou Locher Hoyos Ø (mm)	Interasse Cent. Distance Achsenabstand Distancia entre ejes 	Peso Weight Gewicht Poids
---	--	---	---	---	---	--	--

GRIMME

ZGRM01	SAGOMATORE PATATE RIPORTO ANTIUSURA		50 X 12	-	14.5	100	1600
ZGRM02	SAGOMATORE PATATE RIPORTO ANTIUSURA		45 X 10	-	12.5	80	1300

HAKO

ZHAK01	ZAPPA		40 X 5	C	8.5	72	340
--------	-------	--	--------	---	-----	----	-----

HONDA

ZHON01	F 400 - 80		30 X 6	C Elicoidale	8.5	70	300
ZHON02	501 SCIABOLA		35 X 5	C Elicoidale	10.5	80	350
ZHON03	F 28 - F 28S CD - AD		30 X 4	C	8.5	70	200
ZHON05	F 300 SCIABOLA MZ 106 - 206 Cod Orig:132311342-442		40 X 4	C	8.5	70	290

Tutti gli articoli sono di nostra produzione e non originali. Pesi e misure sono puramente indicativi e possono essere modificati senza preavviso. La riproduzione anche parziale del presente catalogo è vietata. All articles are of our production and not original. Weights and measures are approximate and may change without notice. Reproduction of this catalog is prohibited. Tous les articles sont fabriqués par nous-mêmes et non d'origine. Les poids et mesures sont approximatifs et peuvent changer sans préavis. Alle artikel werden von uns selbst hergestellt und nicht original. Masse und gewichte sind richtwerte und kan ohne vorank undigung gendert werden.

Codice Code Ref. Re. Codigo	Marca e descrizione modello Brand name and model description Constructeur et description du modèle Marke und Modell Beschreibung Marca y modelo de descripción	Quote Dimensions Abmessungen Dimensiones 	Piatto Plate Platte Plaque 	Curvatura Curvature Corbure Krummung 	Foro Hole Trou Locher Hoyos Ø (mm)	Interasse Cent. Distance Achsenabstand Distancia entre ejes 	Peso Weight Gewicht Poids
---	--	---	---	---	---	--	--

HONDA

ZHON06	F 50 - 65		30 X 5	C	8.5	90	250
ZHON07	F 600 - 80		30 X 5	C	8.5	70	70
ZHON08	F 300		30 X 5	C	8.5	70	240
ZHON10	F 201		30 X 4	C Elicoidale	8.5	60	160

HOWARD ROTAVATOR

ZHWR01	ROTALABOUR Cod Orig: 653256-57		60 X 12	D	16.5	50	1200
ZHWR02	ROTALABOUR 1 FORO Cod Orig: 184215-16		60 X 12	D	16.5	-	1160
ZHWR03	ROTALABOUR Cod Orig: 7254-55		50 X 12	D	16.5	50	920

Tutti gli articoli sono di nostra produzione e non originali. Pesì e misure sono puramente indicativi e possono essere modificati senza preavviso. La riproduzione anche parziale del presente catalogo è vietata. All articles are of our production and not original. Weights and measures are approximate and may change without notice. Reproduction of this catalog is prohibited. Tous les articles sont fabriqués par nous-mêmes et non d'origine. Les poids et mesures sont approximatifs et peuvent changer sans préavis. Alle Artikel werden von uns selbst hergestellt und nicht original. Masse und Gewichte sind Richtwerte und können ohne Vorankündigung geändert werden.

Codice Code Ref. Re. Codigo	Marca e descrizione modello Brand name and model description Constructeur et description du modèle Marke und Modell Beschreibung Marca y modelo de descripción	Quote Dimensions Abmessungen Dimensiones 	Piatto Plate Platte Plaque 	Curvatura Curvature Corbure Krummung 	Foro Hole Trou Locher Hoyos Ø (mm)	Interasse Cent. Distance Achsenabstand Distancia entre ejes 	Peso Weight Gewicht Poids
---	--	---	---	---	---	--	--

HOWARD ROTAVATOR

ZHWR04	ROTALABOUR 1 FORO Cod Orig: 3828-29		60 X 12	D	16.5	-	1250
ZHWR05	P - HL Cod Orig: 9923-24		75 X 6	SQ	11.5	57	820
ZHWR06	P - HL Cod Orig: 9953-54		75 X 6	C	11.5	57	800
ZHWR07	ROTALABOUR Cod Orig: 7254-55		50 X 12	D	16.5	50	920
ZHWR08	P - HL Cod Orig: 9876-77		80 X 6	C Elicoidale	11.5	57	850
ZHWR10	U - E Cod Orig: 3900-01		80 X 7	SQ	13.5	57	1100
ZHWR11	U - E Cod Orig: 9948-49		80 X 7	C	13.5	57	1030
ZHWR12	U RINFORZATA		80 X 8	C Elicoidale	13.5	57	1150

Tutti gli articoli sono di nostra produzione e non originali. Pesi e misure sono puramente indicativi e possono essere modificati senza preavviso. La riproduzione anche parziale del presente catalogo è vietata. All articles are of our production and not original. Weights and measures are approximate and may change without notice. Reproduction of this catalog is prohibited. Tous les articles sont fabriqués par nous-même et non d'origine. Les poids et mesurés sont approximatifs et peuvent changer sans préavis. Alle artikel werden von uns selbst hergestellt und nicht original. Masse und gewichte sind richtwerte und kan ohne vorank undigung gendert werden.

Codice Code Ref. Re. Codigo	Marca e descrizione modello Brand name and model description Constructeur et description du modèle Marke und Modell Beschreibung Marca y modelo de descripción	Quote Dimensions Abmessungen Dimensiones 	Piatto Plate Platte Plaque 	Curvatura Curvature Corbure Krummung 	Foro Hole Trou Locher Hoyos Ø (mm) 	Interasse Cent. Distance Achsenabstand Distancia entre ejes 	Peso Weight Gewicht Poids
---	--	---	---	---	---	--	--

HOWARD ROTAVATOR

ZHWR13	U RINFORZATA		80 X 8	SQ Elicoidale	13.5	57	1150
ZHWR14	LONG SHANK		90 X 8	SQ	16.5	51	1580
ZHWR15	ZAPPA Cod Orig: 5978-79		90 X 8	SQ	13.5	57	1550
ZHWR16	E - AR - HR 20 - 30 Cod Orig: 4438-39		90 X 8	C	13.5	57	1300
ZHWR17	E - AR - HR 20 - 30 Cod Orig: 63604-05		90 X 8	SQ	13.5	57	1300
ZHWR18	S - M - AH - HR 40 Cod Orig: 9950-51		90 X 8	C	16.5	51	1450
ZHWR19	S - M - AH - HR 40 Cod Orig: 9862-63		90 X 8	SQ	16.5	51	1300
ZHWR20	TIPO T Cod Orig: 2719-20		105 X 8	SQ	16.5	75	1720

Tutti gli articoli sono di nostra produzione e non originali. Pesi e misure sono puramente indicativi e possono essere modificati senza preavviso. La riproduzione anche parziale del presente catalogo è vietata. All articles are of our production and not original. Weights and measures are approximate and may change without notice. Reproduction of this catalog is prohibited. Tous les articles sont fabriqués par nous-même et non d'origine. Les poids et mesurent approximatifs et peuvent changer sans preavis. Alle artikel werden von uns selbst hergestellt und nicht original. Masse und gewichte sind richtwerte und kan ohne vorank undigung gendert werden.

Codice Code Ref. Re. Codigo	Marca e descrizione modello Brand name and model description Constructeur et description du modèle Marke und Modell Beschreibung Marca y modelo de descripción	Quote Dimensions Abmessungen Dimensiones 	Piatto Plate Platte Plaque 	Curvatura Curvature Corbure Krummung 	Foro Hole Trou Locher Hoyos Ø (mm)	Interasse Cent. Distance Achsenabstand Distancia entre ejes 	Peso Weight Gewicht Poids
---	--	---	---	---	---	--	--

HOWARD ROTAVATOR

ZHWR21	ROTOCADET Cod Orig: 9941-42		40 X 8	C Elicoidale	11.5	114	760
ZHWR23	HA Cod Orig: 994981-881		80 X 7	C Elicoidale	13.5	57	1030
ZHWR25	HA Cod Orig: 624400-01		80 X 7	SQ	11.5	57	1000

KRONE

ZKRN01	RL 3 - 34 - 20 - 0 Cod Orig: 340200-341090		40 X 8	C Elicoidale	12.5	120	760
ZKRN02	RE/S - 35 - 32 - 3 - KS Cod Orig: 352681-354390		65 X 7	SQ	14.5	35	760
ZKRN03	REV/S SUPER BK		80 X 7	C Elicoidale	14.5	57	1020
ZKRN04	REV/S - BK/G 35 - 32 - 5/S Cod Orig: 362730-363950		80 X 7	SQ	14.5	57	980

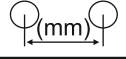

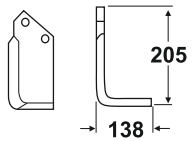
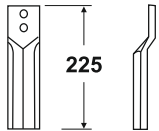

Codice Code Ref. Re. Codigo	Marca e descrizione modello Brand name and model description Constructeur et description du modèle Marke und Modell Beschreibung Marca y modelo de descripción	Quote Dimensions Abmessungen Dimensiones 	Piatto Plate Platte Plaque 	Curvatura Curvature Corbure Krummung 	Foro Hole Trou Locher Hoyos Ø (mm) 	Interasse Cent. Distance Achsenabstand Distancia entre ejes 	Peso Weight Gewicht Poids 
---	--	--	---	--	--	---	---

KRONE

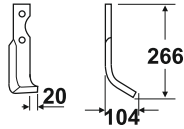
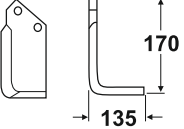
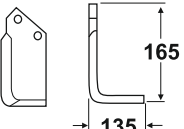
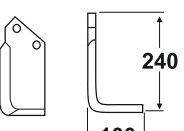
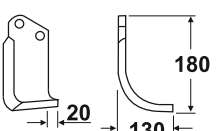
ZKRN05	RF7002/D 2 - 107 - 83 Cod Orig: 1070830-1072690		110 X 8	SQ	16.5	75	1560
ZKRN06	ROTALABOUR		50 X 12	D	14.5	50	1000

KUHN

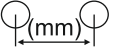
ZKUHO1	EL 30 Cod Orig: 520061-62		40 X 8	C Elicoidale	11.5	115	760
ZKUHO2	EL 35 - 50 N Cod Orig: 521063-64		75 X 6	SQ	11.5	57	750
ZKUHO3	EL 100 - EL 80 Cod Orig: 519215-16		80 X 7	SQ	14.5	57	1000
ZKUHO4	EL 25 - 140N		110 X 7	SQ	16.5	76	1530
ZKUHO5	ZAPPA Cod Orig: 160193-94		70 X 6	C Elicoidale	12.5	41.5	760

Codice Code Ref. Re. Codigo	Marca e descrizione modello Brand name and model description Constructeur et description du modèle Marke und Modell Beschreibung Marca y modelo de descripción	Quote Dimensions Abmessungen Dimensiones 	Piatto Plate Platte Plaque 	Curvatura Curvature Corbure Krummung 	Foro Hole Trou Locher Hoyos Ø (mm)	Interasse Cent. Distance Achsenabstand Distancia entre ejes 	Peso Weight Gewicht Poids 
---	--	--	---	--	---	---	---

KUHN

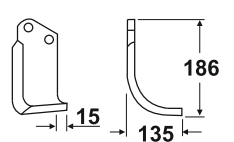
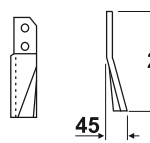
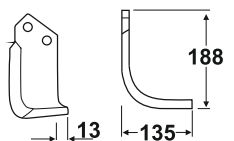
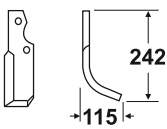
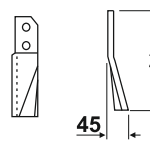
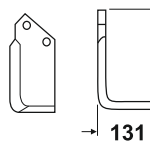
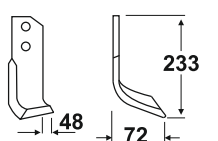
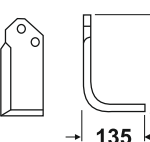
ZKUH06	EL 80N - 81 - 100N Cod Orig: 519370-71		80 X 7	C Elicoidale	14.5	57	980
ZKUH07	DENTE EL 140N - 142 Cod Orig: 522600-01		60 X 12	-	18.5	54	1200
ZKUH08	EL 102 - 142 Cod Orig: 160109-10		90 X 8	C Elicoidale	16.5	57	1160
ZKUH09	EL 32 Cod Orig: 515032-33		60 X 6	C	12.5	86	680
ZKUH10	DENTE EL 80N - 81 - 100N Cod Orig: 519165-66		50 X 12	D	16.5	50	850
ZKUH11	EL 70 - 120 - 80N Cod Orig: 522275-76		80 X 7	SQ	13.5	57	970
ZKUH12	CULTISOC RG 3001 - 2501 Cod Orig: 523219-20		70 X 12	C Elicoidale	18.5	60	1580
ZKUH13	EL 131 Cod Orig: 523248-49		90 X 8	SQ	16.5	57	1270

Codice Code Ref. Re. Codigo	Marca e descrizione modello Brand name and model description Constructeur et description du modèle Marke und Modell Beschreibung Marca y modelo de descripción	Quote Dimensions Abmessungen Dimensiones 	Piatto Plate Platte Plaque 	Curvatura Curvature Corbure Krummung 	Foro Hole Trou Locher Hoyos Ø (mm)	Interasse Cent. Distance Achsenabstand Distancia entre ejes 	Peso Weight Gewicht Poids
---	--	---	---	---	---	--	--





KUHN

ZKUH14	EL 201 Cod Orig: 523590-91		100 X 8	SQ	16.5	76	1600
ZKUH15	CULTIROTOR EL 201 Cod Orig: 523596-97		100 X 8	C Elicoidale	16.5	76	1560
ZKUH16	EL 25 Cod Orig: 520115-16		40 X 8	C	12.5	105	700
ZKUH21	EL 43 Cod Orig: 1605370-80		60 X 6	C	12.5	39	540
ZKUH25	EL 201 Cod Orig: 52359110-901D		105X10	SQ	16.5	76	2000

LAMPACRESCIA

ZLAM01	GR 3 - LRL LAMPINO		30 X 4	C	8.5	41	170
ZLAM02	M 75 - S 50 - S 51		30 X 5	C	8.5	70	220

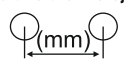
Tutti gli articoli sono di nostra produzione e non originali. Pesi e misure sono puramente indicativi e possono essere modificati senza preavviso. La riproduzione anche parziale del presente catalogo è vietata. All articles are of our production and not original. Weights and measures are approximate and may change without notice. Reproduction of this catalog is prohibited. Tous les articles sont fabriqués par nous-mêmes et non d'origine. Les poids et mesurent approximatifs et peuvent changer sans préavis. Alle artikel werden von uns selbst hergestellt und nicht original. Masse und gewichte sind richtwerte und kan ohne vorank undigung gendert werden.

Codice Code Ref. Re. Codigo	Marca e descrizione modello Brand name and model description Constructeur et description du modèle Marke und Modell Beschreibung Marca y modelo de descripción	Quote Dimensions Abmessungen Dimensiones 	Piatto Plate Platte Plaque 	Curvatura Curvature Corbure Krummung 	Foro Hole Trou Locher Hoyos Ø (mm)	Interasse Cent. Distance Achsenabstand Distancia entre ejes 	Peso Weight Gewicht Poids 
---	--	--	---	--	---	---	---

LAMPACRESCIA

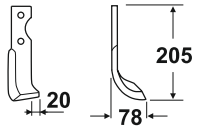
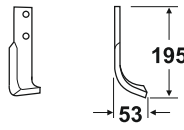
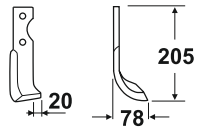
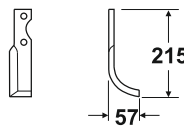
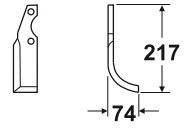
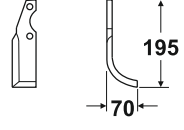
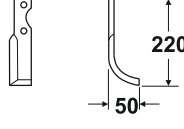
ZLAM03	CASTORO		30 X 5	C Elicoidale	8.5	70	250
ZLAM04	L 70 S		30 X 5	C	10.5	70	230
ZLAM05	KOMBI		25 X 6	C Elicoidale	8.5	55	200
ZLAM06	M - MRS - MMR - 4		35 X 6	C	12.5	72	350
ZLAM07	DL 10 SUPER		45 X 6	C	10.5	70	480
ZLAM08	DL 10 SUPER INTERNA		45 X 6	C	10.5	70	450
ZLAM09	TIPO NUOVO		30 X 4	C	8.5	70.0	200

Codice Code Ref. Re. Codigo	Marca e descrizione modello Brand name and model description Constructeur et description du modèle Marke und Modell Beschreibung Marca y modelo de descripción	Quote Dimensions Abmessungen Dimensiones 	Piatto Plate Platte Plaque 	Curvatura Curvature Corbure Krummung 	Foro Hole Trou Locher Hoyos Ø (mm) 	Interasse Cent. Distance Achsenabstand Distancia entre ejes 	Peso Weight Gewicht Poids 
---	--	--	---	--	--	---	---

MAB

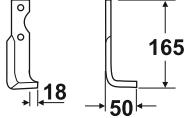
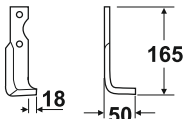
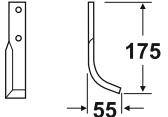
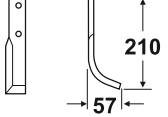
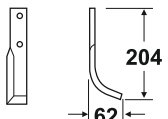
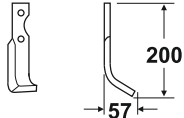
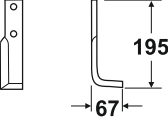
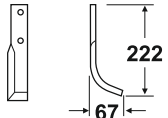
ZMAB01	CICALA Cod Orig: 3149		30 X 4	SQ Elicoidale	8.5	55	220
ZMAB02	NUOVA FORMICA HP 4		30 X 5	SQ Elicoidale	8.5	55	280
ZMAB03	FORMICA HP 5 2T INTERNA		35 X 5	C	10.5	85	270
ZMAB04	FORMICA HP 5 2T ESTERNA		35 X 5	C	10.5	85	320
ZMAB05	FORMICA HP 5 Cod Orig: 2523		35 X 5	SQ	10.5	85	330
ZMAB06	PANDA S110 TIPO VECCHIO		30 X 6	C	8.5	55	270
ZMAB08	FORMICA T3 - NF1 INTERNA Cod Orig: 9063		40 X 5	SSQ	10.5	85	340
ZMAB10	FORMICA T3 - NF1 Cod Orig: 6121		40 X 5	C	10.5	85	380

Tutti gli articoli sono di nostra produzione e non originali. Pesì e misure sono puramente indicativi e possono essere modificati senza preavviso. La riproduzione anche parziale del presente catalogo è vietata. All articles are of our production and not original. Weights and measures are approximate and may change without notice. Reproduction of this catalog is prohibited. Tous les articles sont fabriqués par nous-même et non d'origine. Les poids et mesurés sont approximatifs et peuvent changer sans préavis. Alle artikel werden von uns selbst hergestellt und nicht original. Masse und gewichte sind richtwerte und kan ohne vorank undigung gendert werden.

Codice Code Ref. Re. Codigo	Marca e descrizione modello Brand name and model description Constructeur et description du modèle Marke und Modell Beschreibung Marca y modelo de descripción	Quote Dimensions Abmessungen Dimensiones 	Piatto Plate Platte Plaque 	Curvatura Curvature Corbure Krummung 	Foro Hole Trou Locher Hoyos Ø (mm)	Interasse Cent. Distance Achsenabstand Distancia entre ejes 	Peso Weight Gewicht Poids
---	--	---	---	---	---	--	--

MAB

ZMAB11	FORMICA T3 - NF1		40 X 5	SQ	10.5	85	390
ZMAB12	PANDA 210 Cod Orig: 2783		40 X 5	SQ Elicoidale	8.5	55	340
ZMAB13	FORMICA T4 LUNGA		40 X 6	C	10.5	85	500
ZMAB14	FORMICA T4 Cod Orig: 4152		40 X 6	SQ	10.5	85	530
ZMAB15	FORMICA T4 Cod Orig: 4189		40 X 6	C	10.5	85	500
ZMAB16	TALPA TL 85 Cod Orig: 5161		45 X 6	C	10.5	30	420
ZMAB17	FORMICA T4 INTERNA Cod Orig: 4149		45 X 6	SSQ	10.5	85	500
ZMAB19	FORMICA TIPO FOGGIA		50 X 6	SQ	10.5	85	640

Tutti gli articoli sono di nostra produzione e non originali. Pesì e misure sono puramente indicativi e possono essere modificati senza preavviso. La riproduzione anche parziale del presente catalogo è vietata. All articles are of our production and not original. Weights and measures are approximate and may change without notice. Reproduction of this catalog is prohibited. Tous les articles sont fabriqués par nous-même mes et non d'origine. Les poids et mesurés sont approximatifs et peuvent changer sans préavis. Alle artikel werden von uns selbst hergestellt und nicht original. Masse und gewichte sind richtwerte und kan ohne vorank undigung gendert werden.

Codice Code Ref. Re. Codigo	Marca e descrizione modello Brand name and model description Constructeur et description du modèle Marke und Modell Beschreibung Marca y modelo de descripción	Quote Dimensions Abmessungen Dimensiones 	Piatto Plate Platte Plaque 	Curvatura Curvature Corbure Krummung 	Foro Hole Trou Locher Hoyos Ø (mm)	Interasse Cent. Distance Achsenabstand Distancia entre ejes 	Peso Weight Gewicht Poids
---	--	---	---	---	---	--	--

MAB

ZMAB20	FORMICA TIPO FOGGIA		50 X 6	C	10.5	85	680
ZMAB26	TALPA TL 85 MAGGIORATA		50 X 6	SQ	10.5	30	520
ZMAB30	L 5		80 X 6	SQ	10.5	57	800

MAG

ZMAG01	J 52 - J 525		35 X 6	C	8.5	-	280
ZMAG03	HP 6 - HP 10		35 X 6	C	8.5	-	350
ZMAG05	1 FORO		40 X 6	SQ	10.5	-	440
ZMAG06	1 FORO		40 X 6	C	10.5	-	430

Codice Code Ref. Re. Codigo	Marca e descrizione modello Brand name and model description Constructeur et description du modèle Marke und Modell Beschreibung Marca y modelo de descripción	Quote Dimensions Abmessungen Dimensiones 	Piatto Plate Platte Plaque 	Curvatura Curvature Corbure Krummung 	Foro Hole Trou Locher Hoyos Ø (mm)	Interasse Cent. Distance Achsenabstand Distancia entre ejes 	Peso Weight Gewicht Poids 
---	--	--	---	--	---	---	---

MAG

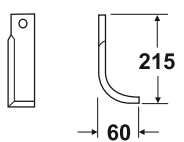
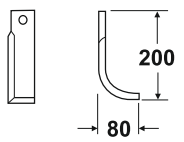
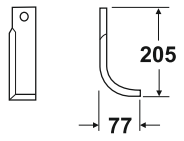
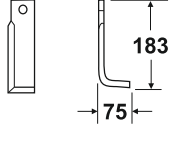
ZMAG07	HP 10 MAGGIORATA		45 X 6	SQ	10.5	-	500
ZMAG08	ARCO		45 X 6	C	10.5	-	400
ZMAG09	ARCO MAGGIORATA		50 X 6	C	10.5	-	560
ZMAG10	1 FORO		40 X 6	SQ	10.5	-	420

MALETTI - KVERNELAND

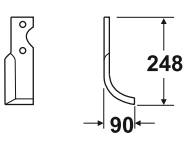
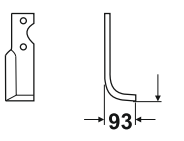
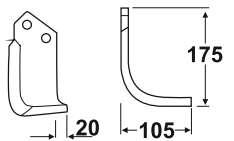
ZMAL01	L Cod Orig: 140077-78		40 X 8	C	12.5	106	650
ZMAL02	L Cod Orig: 140079-80		40 X 8	SQ	12.5	106	680
ZMAL06	PL Cod Orig: 1300077-78		60 X 7	C Elicoidale	14.5	46	710

Tutti gli articoli sono di nostra produzione e non originali. Pesi e misure sono puramente indicativi e possono essere modificati senza preavviso. La riproduzione anche parziale del presente catalogo è vietata. All articles are of our production and not original. Weights and measures are approximate and may change without notice. Reproduction of this catalog is prohibited. Tous les articles sont fabriqués par nous-mêmes et non d'origine. Les poids et mesures sont approximatifs et peuvent changer sans préavis. Alle Artikel werden von uns selbst hergestellt und nicht original. Masse und Gewichte sind Richtwerte und können ohne Vorankündigung geändert werden.

Codice Code Ref. Re. Codigo	Marca e descrizione modello Brand name and model description Constructeur et description du modèle Marke und Modell Beschreibung Marca y modelo de descripción	Quote Dimensions Abmessungen Dimensiones 	Piatto Plate Platte Plaque 	Curvatura Curvature Corbure Krummung 	Foro Hole Trou Locher Hoyos Ø (mm)	Interasse Cent. Distance Achsenabstand Distancia entre ejes 	Peso Weight Gewicht Poids
---	--	---	---	---	---	--	--

MALETTI - KVERNELAND



ZMAL07	PL Cod Orig: 1300079-80		60 X 7	SQ Elicoidale	14.5	46	810
ZMAL08	PL TIPO NUOVO Cod Orig: 1302177-78		60 X 7	C Elicoidale	14.5	40	680
ZMAL09	PL TIPO NUOVO Cod Orig: 1302179-80		60 X 7	SQ Elicoidale	14.5	40	760
ZMAL10	XP		70 X 8	C Elicoidale	14.5	46	900
ZMAL11	XP		70 X 8	SQ Elicoidale	14.5	46	900
ZMAL12	M - P Cod Orig: 100077-78		70 X 8	C Elicoidale	14.5	46	970
ZMAL13	M - P Cod Orig: 100079-80		70 X 8	SQ Elicoidale	14.5	46	1030
ZMAL14	G 3 FORI Cod Orig: 700079-80		75 X 10	SQ Elicoidale	14.5	44 - 44	1250

Tutti gli articoli sono di nostra produzione e non originali. Pesi e misure sono puramente indicativi e possono essere modificati senza preavviso. La riproduzione anche parziale del presente catalogo è vietata. All articles are of our production and not original. Weights and measures are approximate and may change without notice. Reproduction of this catalog is prohibited. Tous les articles sont fabriqués par nous-mêmes et non d'origine. Les poids et mesurent approximatifs et peuvent changer sans préavis. Alle artikel werden von uns selbst hergestellt und nicht original. Masse und gewichte sind richtwerte und kan ohne vorank undigung gendert werden.

Codice Code Ref. Re. Codigo	Marca e descrizione modello Brand name and model description Constructeur et description du modèle Marke und Modell Beschreibung Marca y modelo de descripción	Quote Dimensions Abmessungen Dimensiones 	Piatto Plate Platte Plaque 	Curvatura Curvature Corbure Krummung 	Foro Hole Trou Locher Hoyos Ø (mm)	Interasse Cent. Distance Achsenabstand Distancia entre ejes 	Peso Weight Gewicht Poids
---	--	---	---	---	---	--	--

MALETTI - KVERNELAND

ZMAL15	G 3 FORI Cod Orig: 700077-78		75 X 10	C Elicoidale	14.5	44 - 44	1300
ZMAL17	TIPO K MODULO LAMA BASSA		80 X 8	D	14.5	45	830
ZMAL18	TIPO K MODULO LAMA MEDIA		80 X 8	D	14.5	45	890
ZMAL19	TIPO K MODULO LAMA ALTA		80 X 8	D	14.5	45	980
ZMAL20	B Cod Orig: 500079-80		80 X 8	SQ Elicoidale	14.5	46	1250
ZMAL21	B MAGGIORATA		80 X 8	C Elicoidale	14.5	46	1220
ZMAL22	B Cod Orig: 500077-78		80 X 8	C Elicoidale	14.5	46	1200
ZMAL24	GS		80 X 12	C Elicoidale	14.5	46	1650

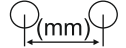
Codice Code Ref. Re. Codigo	Marca e descrizione modello Brand name and model description Constructeur et description du modèle Marke und Modell Beschreibung Marca y modelo de descripción	Quote Dimensions Abmessungen Dimensiones 	Piatto Plate Platte Plaque 	Curvatura Curvature Corbure Krummung 	Foro Hole Trou Locher Hoyos Ø (mm)	Interasse Cent. Distance Achsenabstand Distancia entre ejes 	Peso Weight Gewicht Poids 
---	--	--	---	--	---	---	---



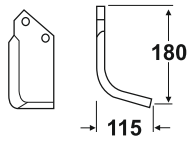
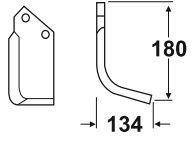

MARZIALTECNICA

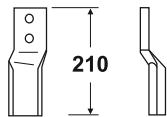
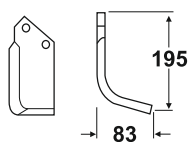
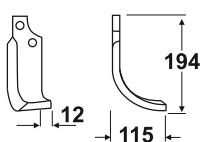
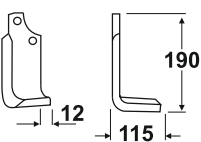
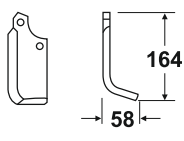
ZMAR01	P		60 X 6	C	12.5	45	600
ZMAR02	N		80 X 6	C	14.5	57	820

MASCHIO

ZMAS01	DENTE COBRA Cod Orig: 24100414-15		50 X 10	-	14.5	44	800
ZMAS03	R - SP 2 - 3 Cod Orig: 566103-153		60 X 6	C	12.5	65	600
ZMAS04	KS - A Cod Orig: 19100417-18		60 X 6	C Elicoidale	12.5	44	650
ZMAS05	KS - A Cod Orig: 19100415-16		60 X 6	SQ Elicoidale	12.5	44	680
ZMAS06	K Cod Orig: 21100412-13		60 X 6	C	10.5	56	460

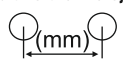
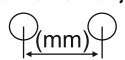
Tutti gli articoli sono di nostra produzione e non originali. Pesi e misure sono puramente indicativi e possono essere modificati senza preavviso. La riproduzione anche parziale del presente catalogo è vietata. All articles are of our production and not original. Weights and measures are approximate and may change without notice. Reproduction of this catalog is prohibited. Tous les articles sont fabriqués par nous-mêmes et non d'origine. Les poids et mesures sont approximatifs et peuvent changer sans préavis. Alle Artikel werden von uns selbst hergestellt und nicht original. Masse und Gewichte sind Richtwerte und können ohne Vorankündigung geändert werden.

Codice Code Ref. Re. Codigo	Marca e descrizione modello Brand name and model description Constructeur et description du modèle Marke und Modell Beschreibung Marca y modelo de descripción	Quote Dimensions Abmessungen Dimensiones 	Piatto Plate Platte Plaque 	Curvatura Curvature Corbure Krummung 	Foro Hole Trou Locher Hoyos Ø (mm) 	Interasse Cent. Distance Achsenabstand Distancia entre ejes 	Peso Weight Gewicht Poids 
---	--	--	---	--	--	---	---

MASCHIO

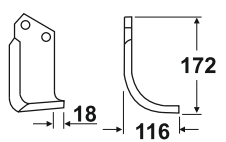
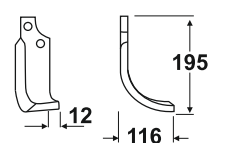
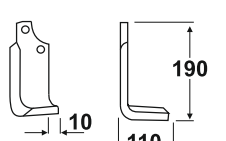
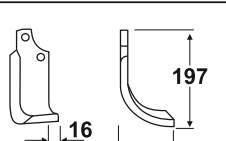
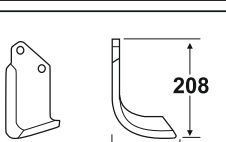
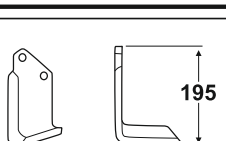
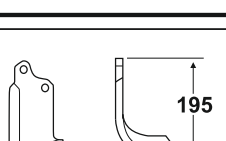
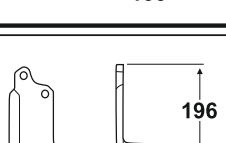
ZMAS07	L - W Cod Orig: 73100404-05		60 X 6	C	12.5	40	600
ZMAS08	W Cod Orig: 48000404-05		60 X 6	C Elicoidale	12.5	44	650
ZMAS09	A - E - H AS - AZ Cod Orig: 19100421-22		70 X 6	SQ Elicoidale	12.5	44	790
ZMAS10	A - E - H AS - AZ Cod Orig: 19100423-24		70 X 6	C Elicoidale	12.5	44	720
ZMAS11	NC - E		70 X 6	C	12.5	44	780
ZMAS12	NC - E		70 X 6	SQ	12.5	44	800
ZMAS13	U		80 X 6	C Elicoidale	14.5	48	920
ZMAS14	U		80 X 6	SQ Elicoidale	14.5	48	950





Tutti gli articoli sono di nostra produzione e non originali. Pesi e misure sono puramente indicativi e possono essere modificati senza preavviso. La riproduzione anche parziale del presente catalogo è vietata. All articles are of our production and not original. Weights and measures are approximate and may change without notice. Reproduction of this catalog is prohibited. Tous les articles sont fabriqués par nous-mêmes et non d'origine. Les poids et mesurent approximatifs et peuvent changer sans préavis. Alle artikel werden von uns selbst hergestellt und nicht original. Masse und gewichte sind richtwerte und kan ohne vorank undigung gendert werden.

Codice Code Ref. Re. Codigo	Marca e descrizione modello Brand name and model description Constructeur et description du modèle Marke und Modell Beschreibung Marca y modelo de descripción	Quote Dimensions Abmessungen Dimensiones 	Piatto Plate Platte Plaque 	Curvatura Curvature Corbure Krummung 	Foro Hole Trou Locher Hoyos Ø (mm)	Interasse Cent. Distance Achsenabstand Distancia entre ejes 	Peso Weight Gewicht Poids
---	--	---	---	---	---	--	--

MASCHIO

ZMAS15	NC - PC - Z Cod Orig: 0208432-33		80 X 6	C Elicoidale	14.5	56	900
ZMAS16	NC - PC - Z Cod Orig: 0208430-31		80 X 6	SQ Elicoidale	14.5	56	920
ZMAS17	NC - PS - Z SILVA - DIANA Cod Orig: 02108430-31		80 X 7	SQ Elicoidale	14.5	56	1050
ZMAS18	NC - PS - Z SILVA - DIANA Cod Orig: 02108432-33		80 X 7	C Elicoidale	14.5	56	980
ZMAS19	U - US - UZ Cod Orig: 29100405-06		80 X 7	C Elicoidale	14.5	48	1030
ZMAS20	U - US - UZ Cod Orig: 29100407-08		80 X 7	SQ Elicoidale	14.5	48	1100
ZMAS21	CL		80 X 7	C Elicoidale	14.5	56	1000
ZMAS22	CL		80 X 7	SQ Elicoidale	14.5	56	1100

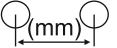
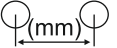
Tutti gli articoli sono di nostra produzione e non originali. Pesi e misure sono puramente indicativi e possono essere modificati senza preavviso. La riproduzione anche parziale del presente catalogo è vietata. All articles are of our production and not original. Weights and measures are approximate and may change without notice. Reproduction of this catalog is prohibited. Tous les articles sont fabriqués par nous-mêmes et non d'origine. Les poids et mesures sont approximatifs et peuvent changer sans préavis. Alle artikel werden von uns selbst hergestellt und nicht original. Masse und gewichte sind richtwerte und kan ohne vorank undigung gendert werden.

Codice Code Ref. Re. Codigo	Marca e descrizione modello Brand name and model description Constructeur et description du modèle Marke und Modell Beschreibung Marca y modelo de descripción	Quote Dimensions Abmessungen Dimensiones 	Piatto Plate Platte Plaque 	Curvatura Curvature Corbure Krummung 	Foro Hole Trou Locher Hoyos Ø (mm) 	Interasse Cent. Distance Achsenabstand Distancia entre ejes 	Peso Weight Gewicht Poids 
---	--	--	---	--	--	---	---

MASCHIO

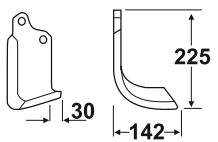
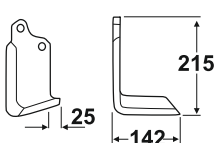
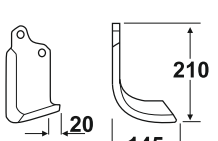
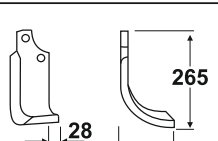
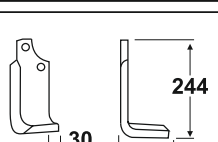
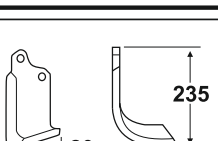
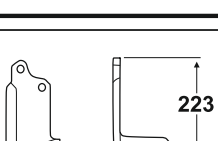
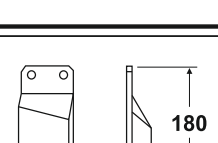
ZMAS23	B - C - SC - PUMA Cod Orig: 01110426-27		80 X 8	C Elicoidale	14.5	56	1300
ZMAS24	B - C - SC - PUMA Cod Orig: 01110428-29		80 X 8	SQ Elicoidale	14.5	56	1360
ZMAS25	C (EX F) TIPO VECCHIO Cod Orig: 13100418-19		80 X 10	C Elicoidale	14.5	56	1600
ZMAS26	G Cod Orig: 20100412-13		90 X 10	C Elicoidale	16.5	68	2000
ZMAS27	G Cod Orig: 20100414-15		90 X 10	SQ Elicoidale	16.5	68	2200
ZMAS28	S Cod Orig: 24100406-07		90 X 8	C Elicoidale	16.5	56	1710
ZMAS29	S Cod Orig: 20100404-05		90 X 8	SQ Elicoidale	16.5	56	1500
ZMAS31	DENTE COBRA SUPERCOBRA - PUMA Cod Orig: 26100417-18		80 X 8	D	14.5	45	900

Codice Code Ref. Re. Codigo	Marca e descrizione modello Brand name and model description Constructeur et description du modèle Marke und Modell Beschreibung Marca y modelo de descripción	Quote Dimensions Abmessungen Dimensiones 	Piatto Plate Platte Plaque 	Curvatura Curvature Corbure Krummung 	Foro Hole Trou Locher Hoyos Ø (mm)	Interasse Cent. Distance Achsenabstand Distancia entre ejes 	Peso Weight Gewicht Poids
---	--	---	---	---	---	--	--

MASCHIO

ZMAS32	A LUNGA MAGGIORATA		70 X 7	SQ Elicoidale	12.5	44	830
ZMAS33	PANTERA Cod Orig: 09400418-19		90 X 10	SQ Elicoidale	16.5	56	1830
ZMAS35	PANTERA Cod Orig: 09400414-15		90 X 10	C Elicoidale	16.5	56	1690
ZMAS36	U LUNGA		80 X 7	SQ Elicoidale	14.5	48	1290
ZMAS38	C		80 X 10	SQ Elicoidale	14.5	56	1670
ZMAS39	VIRAT Cod Orig: M10700423-24		70 X 8	C Elicoidale	12.5	44	950
ZMAS40	VIRAT		70 X 8	SQ Elicoidale	12.5	44	1000
ZMAS43	PANTERA CORTA Cod Orig: M0940045R		90 X 10	SQ	16.5	56	1335

Codice Code Ref. Re. Codigo	Marca e descrizione modello Brand name and model description Constructeur et description du modèle Marke und Modell Beschreibung Marca y modelo de descripción	Quote Dimensions Abmessungen Dimensiones 	Piatto Plate Platte Plaque 	Curvatura Curvature Corbure Krummung 	Foro Hole Trou Locher Hoyos Ø (mm)	Interasse Cent. Distance Achsenabstand Distancia entre ejes 	Peso Weight Gewicht Poids
---	--	---	---	---	---	--	--

MASSANO

ZMSS01	LAMA		60 X 10	Y	14.5	38	960
ZMSS02	LAMA		70 X 10	Y	16.5	53	1400
ZMSS03	LAMA RINFORZATA		70 X 12	Y	16.5	53	1500
ZMSS04	LAMA		60 X 8	Y	14.5	38	680
ZMSS05	INTERRASASSI		90 X 12	-	16.5	57	1660
ZMSS06	ZAPPA		90 X 10	C Elicoidale	16.5	56	2150
ZMSS07	LAMA		60 X 10	Y	14.5	46	950
ZMSS08	INTERRASASSI		90 X 10	-	14.5	57	1200

Tutti gli articoli sono di nostra produzione e non originali. Pesì e misure sono puramente indicativi e possono essere modificati senza preavviso. La riproduzione anche parziale del presente catalogo è vietata. All articles are of our production and not original. Weights and measures are approximate and may change without notice. Reproduction of this catalog is prohibited. Tous les articles sont fabriqués par nous-même mes et non d'origine. Les poids et mesurés sont approximatifs et peuvent changer sans préavis. Alle artikel werden von uns selbst hergestellt und nicht original. Masse und gewichte sind richtwerte und kan ohne vorank undigung gendert werden.

Codice Code Ref. Re. Codigo	Marca e descrizione modello Brand name and model description Constructeur et description du modèle Marke und Modell Beschreibung Marca y modelo de descripción	Quote Dimensions Abmessungen Dimensiones 	Piatto Plate Platte Plaque 	Curvatura Curvature Corbure Krummung 	Foro Hole Trou Locher Hoyos Ø (mm) 	Interasse Cent. Distance Achsenabstand Distancia entre ejes 	Peso Weight Gewicht Poids 
---	--	--	---	--	--	---	---



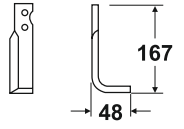
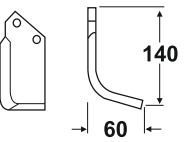
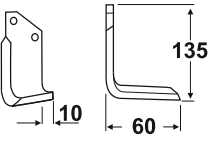
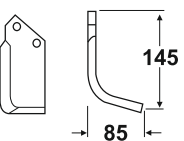
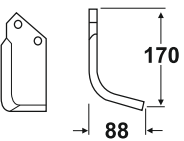

MEAT

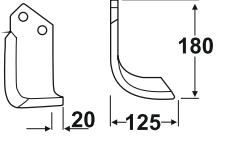
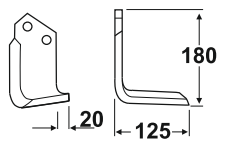
ZMEA01	FM		30 X 6	SQ	8.5	50	280
ZMEA02	MULTIFRESA FM 6 ZAPPE		40 X 6	C	10.5	24	250
ZMEA03	FP		50 X 6	SQ Elicoidale	10.5	35	340
ZMEA04	FPS - FPB		50 X 6	C	12.5	42	460
ZMEA05	FA		60 X 6	C	12.5	42	490

MEO

ZMEO01	C 28 L TIPO LEGGERO		75 X 6	C Elicoidale	12.5	54	730
ZMEO02	C 28 L TIPO LEGGERO		80 X 6	SQ Elicoidale	12.5	54	750

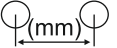
Tutti gli articoli sono di nostra produzione e non originali. Pesì e misure sono puramente indicativi e possono essere modificati senza preavviso. La riproduzione anche parziale del presente catalogo è vietata. All articles are of our production and not original. Weights and measures are approximate and may change without notice. Reproduction of this catalog is prohibited. Tous les articles sont fabriqués par nous-mêmes et non d'origine. Les poids et mesurent approximatifs et peuvent changer sans préavis. Alle artikel werden von uns selbst hergestellt und nicht original. Masse und gewichte sind richtwerte und kan ohne vorank undigung gendert werden.

Codice Code Ref. Re. Codigo	Marca e descrizione modello Brand name and model description Constructeur et description du modèle Marke und Modell Beschreibung Marca y modelo de descripción	Quote Dimensions Abmessungen Dimensiones 	Piatto Plate Platte Plaque 	Curvatura Curvature Corbure Krummung 	Foro Hole Trou Locher Hoyos Ø (mm)	Interasse Cent. Distance Achsenabstand Distancia entre ejes 	Peso Weight Gewicht Poids 
---	--	--	---	--	---	---	---

MERITANO

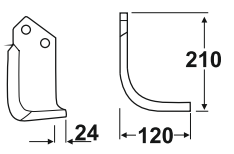
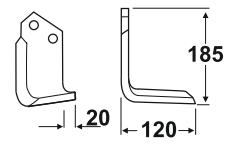
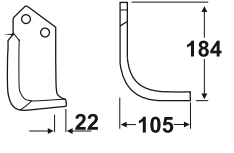
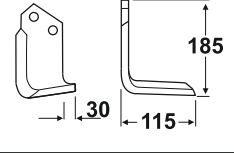
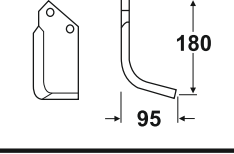
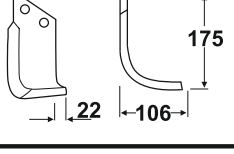
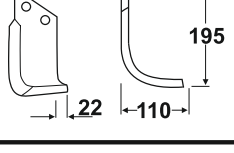
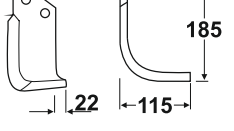
ZMER01	MDV		80 X 8	C Elicoidale	14.5	50	1200
ZMER02	MDV		80 X 8	SQ Elicoidale	14.5	50	1100
ZMER03	TL		80 X 7	C	14.5	50	950
ZMER04	TLS		80 X 7	SQ	14.5	50	900
ZMER05	SEL - M		60 X 6	C Elicoidale	12.5	42	500
ZMER07	TIPO MEDIO		80 X 8	SQ Elicoidale	14.5	50	1150
ZMER08	TIPO PESANTE		80 X 8	SQ Elicoidale	14.5	50	1230
ZMER09	HTL - TL TIPO NUOVO		80 X 7	C Elicoidale	14.5	50	970

Tutti gli articoli sono di nostra produzione e non originali. Pesì e misure sono puramente indicativi e possono essere modificati senza preavviso. La riproduzione anche parziale del presente catalogo è vietata. All articles are of our production and not original. Weights and measures are approximate and may change without notice. Reproduction of this catalog is prohibited. Tous les articles sont fabriqués par nous-même mes et non d'origine. Les poids et mesurés sont approximatifs et peuvent changer sans préavis. Alle artikel werden von uns selbst hergestellt und nicht original. Masse und gewichte sind richtwerte und kan ohne vorank undigung gendert werden.

Codice Code Ref. Re. Codigo	Marca e descrizione modello Brand name and model description Constructeur et description du modèle Marke und Modell Beschreibung Marca y modelo de descripción	Quote Dimensions Abmessungen Dimensiones 	Piatto Plate Platte Plaque 	Curvatura Curvature Corbure Krummung 	Foro Hole Trou Locher Hoyos Ø (mm)	Interasse Cent. Distance Achsenabstand Distancia entre ejes 	Peso Weight Gewicht Poids
---	--	---	---	---	---	--	--

MERITANO

ZMER10	M TIPO PESANTE		80 X 8	C Elicoidale	14.5	50	1120
ZMER11	TLO		80 X 8	C Elicoidale	14.5	50	1100

MGIBI

ZMGB01	M 3		35 X 6	C	10.5	66	350
ZMGB02	940		40 X 6	C	10.5	73	420
ZMGB03	M 6		40 X 6	C	10.5	66	440
ZMGB05	M 4		40 X 6	C	10.5	85	450
ZMGB06	C B 10		50 X 6	C	10.5	41	550

Codice Code Ref. Re. Codigo	Marca e descrizione modello Brand name and model description Constructeur et description du modèle Marke und Modell Beschreibung Marca y modelo de descripción	Quote Dimensions Abmessungen Dimensiones 	Piatto Plate Platte Plaque 	Curvatura Curvature Corbure Krummung 	Foro Hole Trou Locher Hoyos Ø (mm) 	Interasse Cent. Distance Achsenabstand Distancia entre ejes 	Peso Weight Gewicht Poids 
---	--	--	---	--	--	---	---

M GIBI

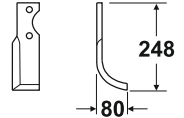
MGB07	M 5		50 X 6	C	10.5	85	700
-------	-----	---	--------	---	------	----	-----

MIRA

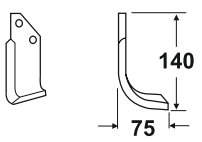
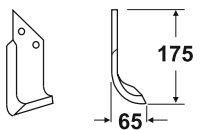
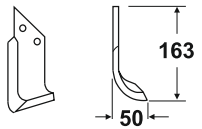
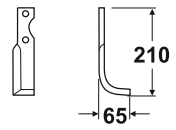
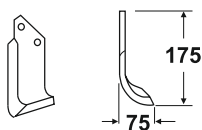
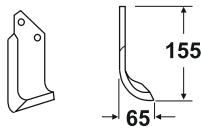
ZMIR01	LISA		40 X 5	C	8.5	30	250
ZMIR02	V2		45 X 6	C	8.5	41	295
ZMIR03	V2 INTERNA		45 X 6	C	8.5	41	270
ZMIR04	DIANA ROSITA		45 X 5	SQ	10.5	76	490
ZMIR05	V4 DIANA		50 X 5	C	10.5	41	400
ZMIR06	V4 DIANA INTERNA		50 X 5	C	10.5	41	350

Codice Code Ref. Re. Codigo	Marca e descrizione modello Brand name and model description Constructeur et description du modèle Marke und Modell Beschreibung Marca y modelo de descripción	Quote Dimensions Abmessungen Dimensiones 	Piatto Plate Platte Plaque 	Curvatura Curvature Corbure Krummung 	Foro Hole Trou Locher Hoyos Ø (mm)	Interasse Cent. Distance Achsenabstand Distancia entre ejes 	Peso Weight Gewicht Poids 
---	--	--	---	--	---	---	---

MIRA

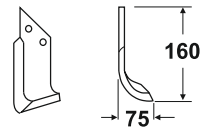
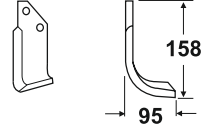
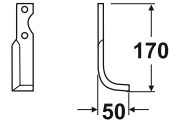
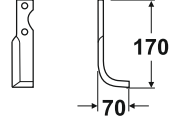
ZMIR07	MINOTAURO		50 X 6	C	10.5	30	450
ZMIR08	SPECIAL		60 X 6	C	10.5	42	530
ZMIR09	LARA		30 X 4	SQ	8.5	55	230
ZMIR10	ROSITA TIPO NUOVO		35 X 5	SQ	8.5	55	320

MURATORI

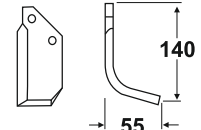
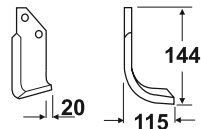
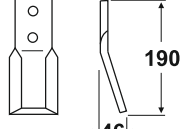
ZMUR01	TIPO 3 - 2L		40 X 6	C	10.5	27	250
ZMUR02	M85 - 125 SPOSTABILE MZ 25 S Cod Orig: 120142-43		50 X 6	C Elicoidale	10.5	27	390
ZMUR03	MZK Cod Orig: 12008701		70 X 10	Y	14.5	44	730

Tutti gli articoli sono di nostra produzione e non originali. Pesi e misure sono puramente indicativi e possono essere modificati senza preavviso. La riproduzione anche parziale del presente catalogo è vietata. All articles are of our production and not original. Weights and measures are approximate and may change without notice. Reproduction of this catalog is prohibited. Tous les articles sont fabriqués par nous-mêmes et non d'origine. Les poids et mesures sont approximatifs et peuvent changer sans préavis. Alle Artikel werden von uns selbst hergestellt und nicht original. Masse und Gewichte sind Richtwerte und können ohne Vorankündigung geändert werden.

Codice Code Ref. Re. Codigo	Marca e descrizione modello Brand name and model description Constructeur et description du modèle Marke und Modell Beschreibung Marca y modelo de descripción	Quote Dimensions Abmessungen Dimensiones 	Piatto Plate Platte Plaque 	Curvatura Curvature Corbure Krummung 	Foro Hole Trou Locher Hoyos Ø (mm)	Interasse Cent. Distance Achsenabstand Distancia entre ejes 	Peso Weight Gewicht Poids
---	--	---	---	---	---	--	--

MURATORI

ZMUR04	MG		60 X 6	C	12.5	123	830
ZMUR05	MA - MS 3 P - MZ 4 Cod Orig: 12000101-201		60 X 6	C Elicoidale	12.5	46	700
ZMUR06	MA - MS 2 P Cod Orig: 120000301-401		60 X 6	SQ Elicoidale	12.5	46	650
ZMUR07	MS 3 P LEGGERA		70 X 6	C Elicoidale	12.5	46	700
ZMUR08	MS 3 P 180 Cod Orig: 120005-06		70 X 7	C Elicoidale	12.5	46	850
ZMUR09	MS 2 - 140 - 160 MS 3 P 180		70 X 7	C Elicoidale	14.5	46	900
ZMUR10	MS 3 P 140 - 160 MS 2 - 100 - 120 Cod Orig: 120007-08		70 X 7	SQ Elicoidale	12.5	46	980
ZMUR11	MS 3 P 180 MS 2 140 - 160		70 X 7	SQ Elicoidale	14.5	46	900



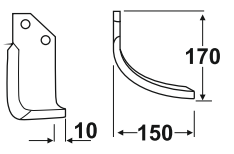
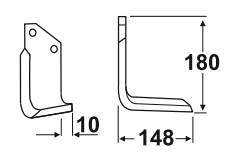
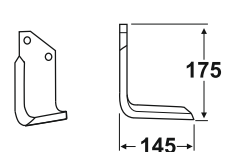
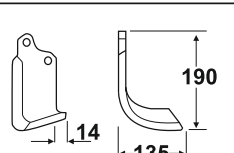
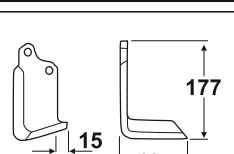
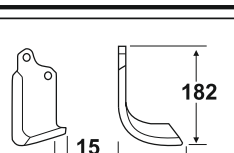
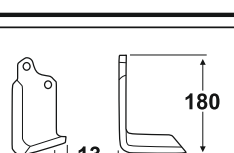
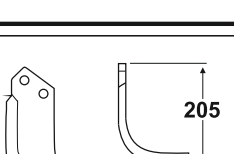

Tutti gli articoli sono di nostra produzione e non originali. Pesi e misure sono puramente indicativi e possono essere modificati senza preavviso. La riproduzione anche parziale del presente catalogo è vietata. All articles are of our production and not original. Weights and measures are approximate and may change without notice. Reproduction of this catalog is prohibited. Tous les articles sont fabriqués par nous-même mes et non d'origine. Les poids et mesurassent approximatifs et peuvent changer sans preavis. Alle artikel werden von uns selbst hergestellt und nicht original. Masse und gewichte sind richtwerte und kan ohne vorank undigung gendert werden.

Codice Code Ref. Re. Codigo	Marca e descrizione modello Brand name and model description Constructeur et description du modèle Marke und Modell Beschreibung Marca y modelo de descripción	Quote Dimensions Abmessungen Dimensiones 	Piatto Plate Platte Plaque 	Curvatura Curvature Corbure Krummung 	Foro Hole Trou Locher Hoyos Ø (mm)	Interasse Cent. Distance Achsenabstand Distancia entre ejes 	Peso Weight Gewicht Poids 
---	--	--	---	--	---	---	---

MURATORI

ZMUR12	MB - MS 3 P MZ 6 6 ZAPPE Cod Orig: 120028-29		70 X 7	C Elicoidale	12.5	46	870
ZMUR13	MB - MS 3 P 85 - 160 MS 2 100 - 120 6 ZAPPE Cod Orig: 120022-23		70 X 7	SQ Elicoidale	12.5	46	900
ZMUR14	MS P 110 - 160 6 ZAPPE		70 X 7	SQ Elicoidale	14.5	46	900
ZMUR16	MZ 8 MZ 8 C 105 - 205 Cod Orig: 120137-38		80 X 6	C Elicoidale	14.5	57	950
ZMUR17	MZ 8 MZ 8 C 105 - 205		80 X 6	SQ Elicoidale	14.5	57	980
ZMUR18	MS - MH Cod Orig: 120125-26		80 X 7	C Elicoidale	14.5	56	1020
ZMUR19	MS - MH Cod Orig: 120127-28		80 X 7	SQ Elicoidale	14.5	56	1050
ZMUR20	TIPO MPR		80 X 8	C	14.5	46	1050

Tutti gli articoli sono di nostra produzione e non originali. Pesi e misure sono puramente indicativi e possono essere modificati senza preavviso. La riproduzione anche parziale del presente catalogo è vietata. All articles are of our production and not original. Weights and measures are approximate and may change without notice. Reproduction of this catalog is prohibited. Tous les articles sont fabriqués par nous-mêmes et non d'origine. Les poids et mesures sont approximatifs et peuvent changer sans préavis. Alle Artikel werden von uns selbst hergestellt und nicht original. Masse und Gewichte sind Richtwerte und können ohne Vorankündigung geändert werden.

Codice Code Ref. Re. Codigo	Marca e descrizione modello Brand name and model description Constructeur et description du modèle Marke und Modell Beschreibung Marca y modelo de descripción	Quote Dimensions Abmessungen Dimensiones 	Piatto Plate Platte Plaque 	Curvatura Curvature Corbure Krummung 	Foro Hole Trou Locher Hoyos Ø (mm) 	Interasse Cent. Distance Achsenabstand Distancia entre ejes 	Peso Weight Gewicht Poids 
---	--	--	---	--	--	---	---

MURATORI

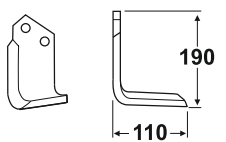
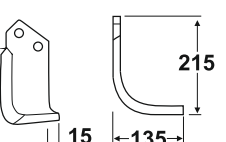
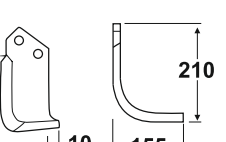
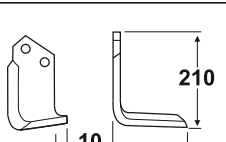
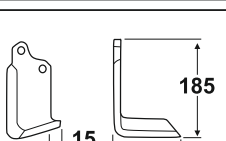
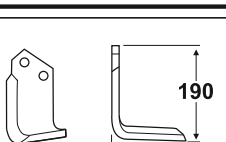
ZMUR21	TIPO MPR		80 X 8	SQ	14.5	46	1140
ZMUR22	MPR LUNGA		80 X 8	C Elicoidale	14.5	46	1350
ZMUR23	MH 130 - 230 Cod Orig: 120060-61		80 X 8	C Elicoidale	14.5	57	1180
ZMUR24	MH 130 - 230 Cod Orig: 120058-59		80 X 8	SQ Elicoidale	14.5	57	1260
ZMUR25	TIPO PESANTE Cod Orig: 120173-74		80 X 10	SQ Elicoidale	14.5	56	1490
ZMUR26	TIPO PESANTE Cod Orig: 120195-96		80 X 10	SQ Elicoidale	16.5	57	1510

NARDI

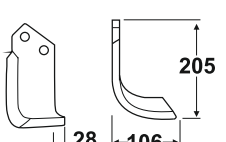
ZNAR01	5C 5009 Cod Orig: 5C5009		60 X 6	C Elicoidale	12.5	45	620
--------	-----------------------------	---	--------	--------------	------	----	-----

Tutti gli articoli sono di nostra produzione e non originali. Pesì e misure sono puramente indicativi e possono essere modificati senza preavviso. La riproduzione anche parziale del presente catalogo è vietata. All articles are of our production and not original. Weights and measures are approximate and may change without notice. Reproduction of this catalog is prohibited. Tous les articles sont fabriqués par nous-mêmes et non d'origine. Les poids et mesurés sont approximatifs et peuvent changer sans préavis. Alle artikel werden von uns selbst hergestellt und nicht original. Masse und gewichte sind richtwerte und kan ohne vorank undigung gendert werden.

Codice Code Ref. Re. Codigo	Marca e descrizione modello Brand name and model description Constructeur et description du modèle Marke und Modell Beschreibung Marca y modelo de descripción	Quote Dimensions Abmessungen Dimensiones 	Piatto Plate Platte Plaque 	Curvatura Curvature Corbure Krummung 	Foro Hole Trou Locher Hoyos Ø (mm)	Interasse Cent. Distance Achsenabstand Distancia entre ejes 	Peso Weight Gewicht Poids
---	--	---	---	---	---	--	--

NARDI

ZNAR02	5C 5015 Cod Orig: 5C5015		60 X 6	C	10.5	40	620
ZNAR03	6C 5010 Cod Orig: 6C5010		60 X 6	C	10.5	45	630
ZNAR05	6C 5009 Cod Orig: 6C5009		70 X 6	C Elicoidale	12.5	45	700
ZNAR06	5C 5013 Cod Orig: 5C5013		70 X 7	C Elicoidale	12.5	55	860
ZNAR07	4C 5012 Cod Orig: 4C5012		70 X 7	C	12.5	55	900
ZNAR08	5C 5012 INTERFILARE Cod Orig: 5C5012		70 X 7	C	12.5	55	850
ZNAR09	5C 5013 Z 14 - Z 16 Cod Orig: 5C 5013		70 X 7	SQ	12.5	55	900
ZNAR10	5 1/2 C 5002 Cod Orig: 51/2C5002		80 X 7	SQ	12.5	55	1050

Tutti gli articoli sono di nostra produzione e non originali. Pesi e misure sono puramente indicativi e possono essere modificati senza preavviso. La riproduzione anche parziale del presente catalogo è vietata. All articles are of our production and not original. Weights and measures are approximate and may change without notice. Reproduction of this catalog is prohibited. Tous les articles sont fabriqués par nous-mêmes et non d'origine. Les poids et mesurent approximatifs et peuvent changer sans préavis. Alle artikel werden von uns selbst hergestellt und nicht original. Masse und gewichte sind richtwerte und kan ohne vorank undigung gendert werden.

Codice Code Ref. Re. Codigo	Marca e descrizione modello Brand name and model description Constructeur et description du modèle Marke und Modell Beschreibung Marca y modelo de descripción	Quote Dimensions Abmessungen Dimensiones 	Piatto Plate Platte Plaque 	Curvatura Curvature Corbure Krummung 	Foro Hole Trou Locher Hoyos Ø (mm)	Interasse Cent. Distance Achsenabstand Distancia entre ejes 	Peso Weight Gewicht Poids
---	--	---	---	---	---	--	--

NARDI

ZNAR11	6 1/2 C 5002 Cod Orig: 61/2C5002		80 X 7	SQ	14.5	55	1090
ZNAR12	8C 5013 Z6 Cod Orig: 8C5013		80 X 7	C Elicoidale	14.5	55	1000
ZNAR13	5 1/2 C 5012 ZM Cod Orig: 51/2C50012		80 X 7	C	12.5	55	1000
ZNAR14	8C 5003 Cod Orig: 8C5003		80 X 8	SQ Elicoidale	14.5	55	1150
ZNAR15	7C 5002 Z P A Cod Orig: 7C5002		80 X 8	SQ	14.5	55	1350
ZNAR16	8C 5013 Cod Orig: 8C5013		80 X 8	C	14.5	55	1140
ZNAR17	7C 5012 Z P A Cod Orig: 7C5012		80 X 8	C	14.5	55	1100
ZNAR18	6C 5009 Cod Orig: 6C5009		70 X 6	SQ	12.5	45	720

Tutti gli articoli sono di nostra produzione e non originali. Pesi e misure sono puramente indicativi e possono essere modificati senza preavviso. La riproduzione anche parziale del presente catalogo è vietata. All articles are of our production and not original. Weights and measures are approximate and may change without notice. Reproduction of this catalog is prohibited. Tous les articles sont fabriqués par nous-même et non d'origine. Les poids et mesurent approximatifs et peuvent changer sans preavis. Alle artikel werden von uns selbst hergestellt und nicht original. Masse und gewichte sind richtwerte und kan ohne vorank undigung gendert werden.

Codice Code Ref. Re. Codigo	Marca e descrizione modello Brand name and model description Constructeur et description du modèle Marke und Modell Beschreibung Marca y modelo de descripción	Quote Dimensions Abmessungen Dimensiones 	Piatto Plate Platte Plaque 	Curvatura Curvature Corbure Krummung 	Foro Hole Trou Locher Hoyos Ø (mm)	Interasse Cent. Distance Achsenabstand Distancia entre ejes 	Peso Weight Gewicht Poids
---	--	---	---	---	---	--	--

NARDI

ZNAR19	SC 5001		60 X 6	SQ Elicoidale	12.5	45	640
--------	---------	--	--------	------------------	------	----	-----

NIBBI BRUNO - YABE

ZNIB01	MOTOCOLTIVATORE TOP MAX 305 Cod Orig: K3501780-90		25 X 5	C Elicoidale	8.5	58	180
ZNIB02	MOTOCOLTIVATORE TOP MAX 305		25 X 6	SQ	8.5	58	180
ZNIB04	E LUNGA		30 X 6	C	8.5	40	300
ZNIB05	G 719 TIPO NUOVO		30 X 6	SQ	8.5	37	250
ZNIB06	E - G 519 TIPO VECCHIO		35 X 6	SQ	8.5	37	350
ZNIB07	ARTIGLIO E - G 519		35 X 6	C	8.5	37	330

Tutti gli articoli sono di nostra produzione e non originali. Pesi e misure sono puramente indicativi e possono essere modificati senza preavviso. La riproduzione anche parziale del presente catalogo è vietata. All articles are of our production and not original. Weights and measures are approximate and may change without notice. Reproduction of this catalog is prohibited. Tous les articles sont fabriqués par nous-mêmes et non d'origine. Les poids et mesures sont approximatifs et peuvent changer sans préavis. Alle Artikel werden von uns selbst hergestellt und nicht original. Masse und Gewichte sind Richtwerte und können ohne Vorankündigung geändert werden.

Codice Code Ref. Re. Codigo	Marca e descrizione modello Brand name and model description Constructeur et description du modèle Marke und Modell Beschreibung Marca y modelo de descripción	Quote Dimensions Abmessungen Dimensiones 	Piatto Plate Platte Plaque 	Curvatura Curvature Corbure Krummung 	Foro Hole Trou Locher Hoyos Ø (mm)	Interasse Cent. Distance Achsenabstand Distancia entre ejes 	Peso Weight Gewicht Poids
---	--	---	---	---	---	--	--

NIBBI BRUNO - YABE

ZNIB08	B		35 X 8	C	10.5	56	520
ZNIB09	G 519 TIPO NUOVO 600 - 700 Cod Orig: K4303230-40		50 X 6	C	10.5	42	350
ZNIB10	ARTIGLIO G 519 TIPO VECCHIO		50 X 6	C	8.5	42	410
ZNIB13	G 119		60 X 6	C Elicoidale	12.5	42	540
ZNIB14	G 119		60 X 6	SQ	12.5	42	600
ZNIB15	G 520		60 X 6	SQ Elicoidale	12.5	42	550
ZNIB16	ZAPPA		30 X 4	C	12.5	65	180
ZNIB17	GRIFO		30 X 5	SQ	8.5	36	200

Codice Code Ref. Re. Codigo	Marca e descrizione modello Brand name and model description Constructeur et description du modèle Marke und Modell Beschreibung Marca y modelo de descripción	Quote Dimensions Abmessungen Dimensiones 	Piatto Plate Platte Plaque 	Curvatura Curvature Corbure Krummung 	Foro Hole Trou Locher Hoyos Ø (mm)	Interasse Cent. Distance Achsenabstand Distancia entre ejes 	Peso Weight Gewicht Poids 
---	--	--	---	--	---	---	---

NIBBI BRUNO - YABE

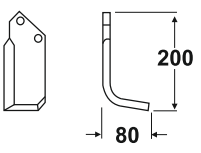
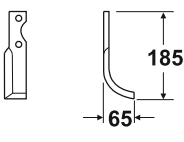
ZNIB18	G 119 MAGGIORATA		70 X 6	C	12.5	42	670
ZNIB19	095 - 104 - 105 Cod Orig: 66150975		30 X 4	C	8.5	70	170

NIBBI DECIMO

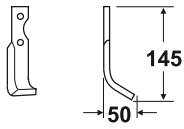
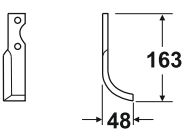
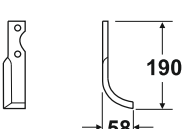
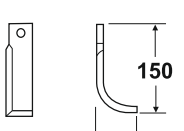
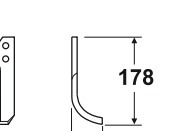
ZNID01	GRIFO RM		25 X 5	C Elicoidale	8.5	55	110
ZNID02	GRIFO JUNIOR		30 X 5	C	8.5	55	220
ZNID03	GRIFO ORION		30 X 5	C	8.5	72	230
ZNID04	GRIFO 1 FORO		30 X 6	C	8.5	-	220
ZNID05	GRIFO CZ 7		30 X 6	C	8.5	35	250





Tutti gli articoli sono di nostra produzione e non originali. Pesi e misure sono puramente indicativi e possono essere modificati senza preavviso. La riproduzione anche parziale del presente catalogo è vietata. All articles are of our production and not original. Weights and measures are approximate and may change without notice. Reproduction of this catalog is prohibited. Tous les articles sont fabriqués par nous-mêmes et non d'origine. Les poids et mesures sont approximatifs et peuvent changer sans préavis. Alle Artikel werden von uns selbst hergestellt und nicht original. Masse und Gewichte sind Richtwerte und können ohne Vorankündigung geändert werden.

Codice Code Ref. Re. Codigo	Marca e descrizione modello Brand name and model description Constructeur et description du modèle Marke und Modell Beschreibung Marca y modelo de descripción	Quote Dimensions Abmessungen Dimensiones 	Piatto Plate Platte Plaque 	Curvatura Curvature Corbure Krummung 	Foro Hole Trou Locher Hoyos Ø (mm)	Interasse Cent. Distance Achsenabstand Distancia entre ejes 	Peso Weight Gewicht Poids
---	--	---	---	---	---	--	--

NIBBI DECIMO

ZNID06	GRIFO EXPORT		35 X 5	SQ	8.5	35	340
ZNID07	GRIFO EXPORT		35 X 5	C	8.5	72	300
ZNID08	GRIFO MOD. 22 - 28		40 X 6	C	10.5	65	410
ZNID09	GRIFO MAJOR		40 X 6	SQ	10.5	35	410
ZNID10	GRIFO MAJOR		45 X 5	C	8.5	35	350
ZNID11	GRIFO EXTRA		50 X 6	C	8.5	35	400
ZNID12	GRIFO EXTRA LUNGA		50 X 6	C	8.5	35	450
ZNID13	GRIFO		30 X 5	SQ	8.5	32	200

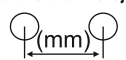
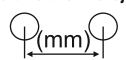
Tutti gli articoli sono di nostra produzione e non originali. Pesì e misure sono puramente indicativi e possono essere modificati senza preavviso. La riproduzione anche parziale del presente catalogo è vietata. All articles are of our production and not original. Weights and measures are approximate and may change without notice. Reproduction of this catalog is prohibited. Tous les articles sont fabriqués par nous-mêmes et non d'origine. Les poids et mesures sont approximatifs et peuvent changer sans préavis. Alle Artikel werden von uns selbst hergestellt und nicht original. Masse und Gewichte sind Richtwerte und können ohne Vorankündigung geändert werden.

Codice Code Ref. Re. Codigo	Marca e descrizione modello Brand name and model description Constructeur et description du modèle Marke und Modell Beschreibung Marca y modelo de descripción	Quote Dimensions Abmessungen Dimensiones 	Piatto Plate Platte Plaque 	Curvatura Curvature Corbure Krummung 	Foro Hole Trou Locher Hoyos Ø (mm) 	Interasse Cent. Distance Achsenabstand Distancia entre ejes 	Peso Weight Gewicht Poids 
---	--	--	---	--	--	---	---

MMAS

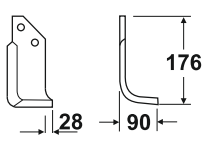
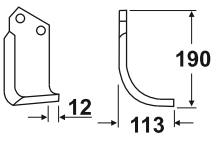

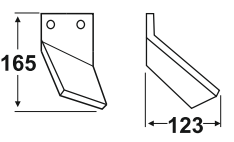
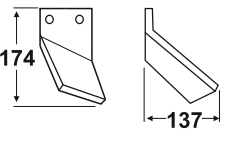
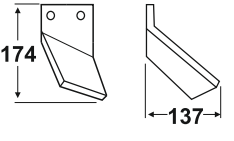
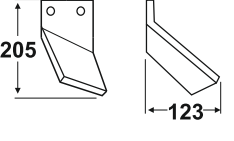

ZOMM01	FS M/5 INTERFILARE		40 X 8	C Elicoidale	12.5	41	500
ZOMM02	140 PRESTIGE		70 X 7	C Elicoidale	14.5	46	860

ORTIFLOR

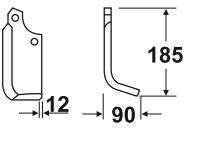
ZORF01	INTERRASASSI TSA - TSR Cod Orig: 344002		90 X 12	-	14.5	56	1600
ZORF02	INTERRASASSI TSA - TSR LUNGO Cod Orig: 344002L		90 X 12	-	14.5	56	1700
ZORF03	INTERRASASSI TSA - TSR		90 X 8	-	14.5	56	1050
ZORF04	INTERRASASSI TSP Cod Orig: 344001		90 X 12	-	14.5	56	1850

ORTOLAN

ZORT01	TIPO G		60 X 6	C Elicoidale	12.5	65	480
--------	--------	---	--------	-----------------	------	----	-----

Codice Code Ref. Re. Codigo	Marca e descrizione modello Brand name and model description Constructeur et description du modèle Marke und Modell Beschreibung Marca y modelo de descripción	Quote Dimensions Abmessungen Dimensiones 	Piatto Plate Platte Plaque 	Curvatura Curvature Corbure Krummung 	Foro Hole Trou Locher Hoyos Ø (mm)	Interasse Cent. Distance Achsenabstand Distancia entre ejes 	Peso Weight Gewicht Poids 
---	--	--	---	--	---	---	---

ORTOLAN

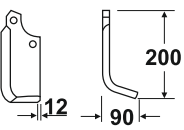
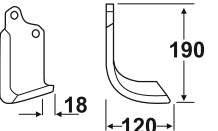
ZORT02	TIPO L		60 X 6	C Elicoidale	12.5	65	500
ZORT03	TIPO P		80 X 7	C Elicoidale	14.5	56	900

PALLADINO

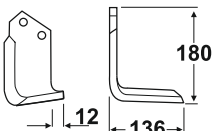
ZPLD01	ZAPPA		80 X 8	SQ. Elicoidale	14.5	57	1200
--------	-------	---	--------	-------------------	------	----	------

PASBO

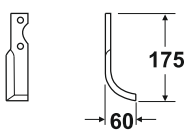
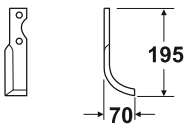
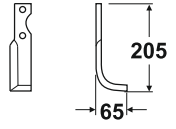
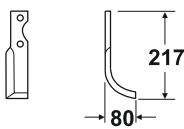
ZPAB01	G 31 Cod Orig: 031059000		30 X 5	C Elicoidale	8.5	50	180
ZPAB02	G 2 - G 51 - G 62 Cod Orig: 051475000		35 X 6	C	8.5	73	350
ZPAB03	G 51 - G 83		35 X 6	SQ	8.5	73	360
ZPAB05	G 11 - G 14 - G 72 G 83 - G 84 - G 93 Cod Orig: 072059001		40 X 6	C	10.5	73	420

Codice Code Ref. Re. Codigo	Marca e descrizione modello Brand name and model description Constructeur et description du modèle Marke und Modell Beschreibung Marca y modelo de descripción	Quote Dimensions Abmessungen Dimensiones 	Piatto Plate Platte Plaque 	Curvatura Curvature Corbure Krummung 	Foro Hole Trou Locher Hoyos Ø (mm)	Interasse Cent. Distance Achsenabstand Distancia entre ejes 	Peso Weight Gewicht Poids
---	--	---	---	---	---	--	--

PASBO

ZPAB06	G 11 - G 14 - G 72 G 83 - G 84 - G 93		40 X 6	SQ	10.5	73	460
ZPAB07	G 11 MAGGIORATA		45 X 6	C	10.5	73	500
ZPAB08	G11 MAGGIORATA		45 X 6	SQ	10.5	73	510
ZPAB09	G 84 - G 94 GROTTAGLIE Cod Orig: 094059000		50 X 6	C	10.5	73	550
ZPAB10	G 84 - G 94 GROTTAGLIE		50 X 6	SQ	10.5	73	600
ZPAB11	BONGO		60 X 6	C	10.5	38	580
ZPAB12	G 14 Cod Orig: 014062001		60 X 6	C	10.5	73	650

Codice Code Ref. Re. Codigo	Marca e descrizione modello Brand name and model description Constructeur et description du modèle Marke und Modell Beschreibung Marca y modelo de descripción	Quote Dimensions Abmessungen Dimensiones 	Piatto Plate Platte Plaque 	Curvatura Curvature Corbure Krummung 	Foro Hole Trou Locher Hoyos Ø (mm)	Interasse Cent. Distance Achsenabstand Distancia entre ejes 	Peso Weight Gewicht Poids
---	--	---	---	---	---	--	--

PASQUALI

ZPAS01	532 - 938 - 495 - 498 Cod Orig: 500160-61		25 X 5	C	8.5	68	190
ZPAS02	532 TIPO NUOVO 461 - 465 - 402 - 404 406 - 938 - 490 - 411 Cod Orig: 532211-12		30 X 6	C Elicoidale	10.5	68	290
ZPAS03	AX 20 - 21 599 TIPO VECCHIO		35 X 8	C Elicoidale	10.5	79	520
ZPAS04	591 901 - 909 CORTA 913 - 921 LUNGA Cod Orig: 500095-96		50 X 6	C	10.5	32	310
ZPAS05	588 - 912 - 923 911 - 914 - 934		50 X 6	SSQ	10.5	32	350
ZPAS06	478 428 TIPO NUOVO 532 TIPO NUOVO Cod Orig: 500098-99		50 X 6	C	10.5	42	420
ZPAS07	NF 557 - 917 - 922 Cod Orig: 500093-94		60 X 6	SSQ	12.5	42	540
ZPAS08	NF 592 - 598 ORIG.		60 X 6	SQ	12.5	42	560

Tutti gli articoli sono di nostra produzione e non originali. Pesi e misure sono puramente indicativi e possono essere modificati senza preavviso. La riproduzione anche parziale del presente catalogo è vietata. All articles are of our production and not original. Weights and measures are approximate and may change without notice. Reproduction of this catalog is prohibited. Tous les articles sont fabriqués par nous-mêmes et non d'origine. Les poids et mesures sont approximatifs et peuvent changer sans préavis. Alle Artikel werden von uns selbst hergestellt und nicht original. Masse und Gewichte sind Richtwerte und können ohne Vorankündigung geändert werden.

Codice Code Ref. Re. Codigo	Marca e descrizione modello Brand name and model description Constructeur et description du modèle Marke und Modell Beschreibung Marca y modelo de descripción	Quote Dimensions Abmessungen Dimensiones 	Piatto Plate Platte Plaque 	Curvatura Curvature Corbure Krummung 	Foro Hole Trou Locher Hoyos Ø (mm) 	Interasse Cent. Distance Achsenabstand Distancia entre ejes 	Peso Weight Gewicht Poids 
---	--	--	---	--	--	---	---

PASQUALI

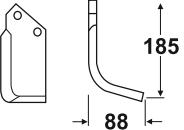
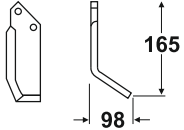
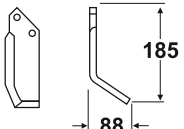
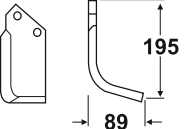
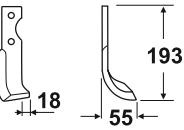
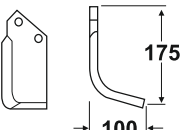
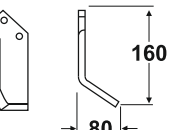
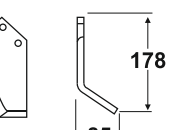
ZPAS09	592 - 917 - 598 - 946 956 - 959 - 596 - 491 Cod Orig: 500112-13		60 X 6	C	12.5	42	650
ZPAS10	ZAPPA		60 X 6	SSQ	12.5	42	580
ZPAS11	FRESA TIPO CALABRIA		70 X 6	SQ	12.5	42	760
ZPAS12	NF 592 - 598 946 TIPO NUOVO LUNGA		60 X 6	C	12.5	42	580
ZPAS13	XB 40 - SB 30		30 X 6	SQ Elicoidale	8.5	55	280
ZPAS14	ZAPPA		60 X 6	C	12.5	42	550
ZPAS15	ZAPPA		60 X 6	SSQ	12.5	42	480
ZPAS16	ZAPPA		60 X 6	SSQ	12.5	42	520

Tutti gli articoli sono di nostra produzione e non originali. Pesi e misure sono puramente indicativi e possono essere modificati senza preavviso. La riproduzione anche parziale del presente catalogo è vietata. All articles are of our production and not original. Weights and measures are approximate and may change without notice. Reproduction of this catalog is prohibited. Tous les articles sont fabriqués par nous-mêmes et non d'origine. Les poids et mesures sont approximatifs et peuvent changer sans préavis. Alle Artikel werden von uns selbst hergestellt und nicht original. Masse und Gewichte sind Richtwerte und können ohne Vorankündigung geändert werden.

Codice Code Ref. Re. Codigo	Marca e descrizione modello Brand name and model description Constructeur et description du modèle Marke und Modell Beschreibung Marca y modelo de descripción	Quote Dimensions Abmessungen Dimensiones 	Piatto Plate Platte Plaque 	Curvatura Curvature Corbure Krummung 	Foro Hole Trou Locher Hoyos Ø (mm)	Interasse Cent. Distance Achsenabstand Distancia entre ejes 	Peso Weight Gewicht Poids
---	--	---	---	---	---	--	--

PEGORARO

ZPEG01	FA Cod Orig: 6729-30		50 X 6	C	10.5	38	320
ZPEG02	TL Cod Orig: 3300-01		60 X 6	C Elicoidale	12.5	90	790
ZPEG04	COLTELLO LB Cod Orig: 5329		60 X 10	Y	12.5	50	670
ZPEG05	TN - TB Cod Orig: 1852-53		70 X 7	C	12.5	54	820
ZPEG06	TN - TB Cod Orig: 2191-92		70 X 7	SQ Elicoidale	12.5	54	900
ZPEG07	COLTELLO LM Cod Orig: 5333		70 X 10	Y	14.5	50	930
ZPEG10	AC - AD - TC - TD Cod Orig: 4585-86		80 X 8	C Elicoidale	14.5	57	1200
ZPEG11	AC - AD Cod Orig: 5378-79		80 X 8	SQ Elicoidale	14.5	57	1280

Tutti gli articoli sono di nostra produzione e non originali. Pesi e misure sono puramente indicativi e possono essere modificati senza preavviso. La riproduzione anche parziale del presente catalogo è vietata. All articles are of our production and not original. Weights and measures are approximate and may change without notice. Reproduction of this catalog is prohibited. Tous les articles sont fabriqués par nous-mêmes et non d'origine. Les poids et mesures sont approximatifs et peuvent changer sans préavis. Alle Artikel werden von uns selbst hergestellt und nicht original. Masse und Gewichte sind Richtwerte und können ohne Vorankündigung geändert werden.

Codice Code Ref. Re. Codigo	Marca e descrizione modello Brand name and model description Constructeur et description du modèle Marke und Modell Beschreibung Marca y modelo de descripción	Quote Dimensions Abmessungen Dimensiones 	Piatto Plate Platte Plaque 	Curvatura Curvature Corbure Krummung 	Foro Hole Trou Locher Hoyos Ø (mm)	Interasse Cent. Distance Achsenabstand Distancia entre ejes 	Peso Weight Gewicht Poids 
---	--	--	---	--	---	---	---

PEGORARO

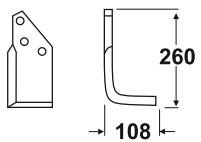
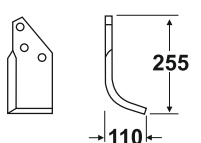
ZPEG12	TS 3 FORI Cod Orig: 1675-76		80 X 8	SQ	10.5	60 - 116	1450
ZPEG13	TS 3 FORI Cod Orig: 0833-34		80 X 8	C	12.5	60 - 116	1350



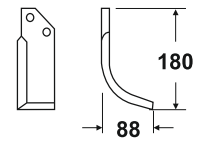
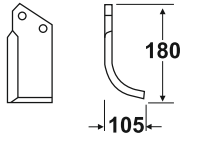
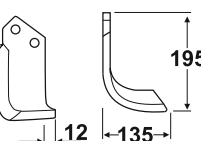
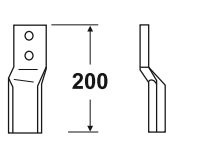

PERUGINI CONCEPT

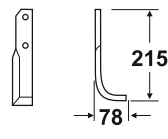
ZPER01	KF - EF - ZF KFG - KFW		60 X 6	C	12.5	42	700
ZPER02	AF - BF - TF		70 X 6	C Elicoidale	12.5	42	750
ZPER03	MF		80 X 7	C Elicoidale	14.5	57	980
ZPER04	ROTOLABOUR		60 X 12	D	16.5	46	1100

PGS

ZPGS01	SMERALDO 1500		30 X 6	C	8.5	81	320
--------	---------------	---	--------	---	-----	----	-----

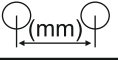
Tutti gli articoli sono di nostra produzione e non originali. Pesi e misure sono puramente indicativi e possono essere modificati senza preavviso. La riproduzione anche parziale del presente catalogo è vietata. All articles are of our production and not original. Weights and measures are approximate and may change without notice. Reproduction of this catalog is prohibited. Tous les articles sont fabriqués par nous-mêmes et non d'origine. Les poids et mesures sont approximatifs et peuvent changer sans préavis. Alle Artikel werden von uns selbst hergestellt und nicht original. Masse und Gewichte sind Richtwerte und können ohne Vorankündigung geändert werden.

Codice Code Ref. Re. Codigo	Marca e descrizione modello Brand name and model description Constructeur et description du modèle Marke und Modell Beschreibung Marca y modelo de descripción	Quote Dimensions Abmessungen Dimensiones 	Piatto Plate Platte Plaque 	Curvatura Curvature Corbure Krummung 	Foro Hole Trou Locher Hoyos Ø (mm)	Interasse Cent. Distance Achsenabstand Distancia entre ejes 	Peso Weight Gewicht Poids 
---	--	--	---	--	---	---	---

PGS

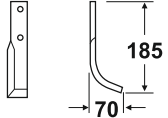
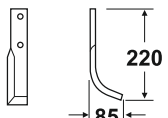
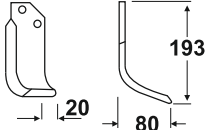
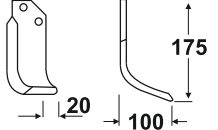
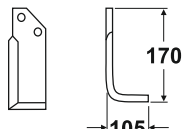
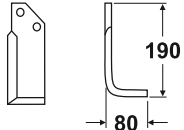
ZPGS02	ATTILA 2500		40 X 6	C	12.5	54	420
ZPGS03	ATTILA MTR 11		45 X 8	C	12.5	58	650
ZPGS04	SCIABOLA F2150		50 X 8	C Elicoidale	12.5	36	630
ZPGS05	ROMA E 2150		50 X 8	C Elicoidale	12.5	36	620
ZPGS06	M 18 CV		70 X 7	SQ	12.5	36	860
ZPGS07	ZIANO		60 X 6	SQ	12.5	36	640

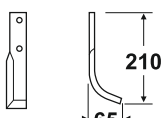

RANDI

ZRAN01	6500		35 X 5	C	10.5	85	300
--------	------	---	--------	---	------	----	-----

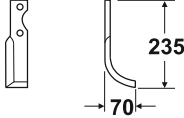
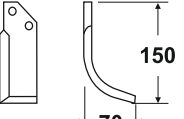
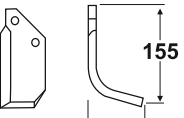

Tutti gli articoli sono di nostra produzione e non originali. Pesì e misure sono puramente indicativi e possono essere modificati senza preavviso. La riproduzione anche parziale del presente catalogo è vietata. All articles are of our production and not original. Weights and measures are approximate and may change without notice. Reproduction of this catalog is prohibited. Tous les articles sont fabriqués par nous-mêmes et non d'origine. Les poids et mesurés sont approximatifs et peuvent changer sans préavis. Alle artikel werden von uns selbst hergestellt und nicht original. Masse und gewichte sind richtwerte und kan ohne vorank undigung gendert werden.

Codice Code Ref. Re. Codigo	Marca e descrizione modello Brand name and model description Constructeur et description du modèle Marke und Modell Beschreibung Marca y modelo de descripción	Quote Dimensions Abmessungen Dimensiones 	Piatto Plate Platte Plaque 	Curvatura Curvature Corbure Krummung 	Foro Hole Trou Locher Hoyos Ø (mm)	Interasse Cent. Distance Achsenabstand Distancia entre ejes 	Peso Weight Gewicht Poids 
---	--	--	---	--	---	---	---

RANDI

ZRAN02	2000 BIETOLE		40 X 6	C	10.5	90	500
ZRAN04	4000 - 6000		50 X 6	C	10.5	32	540
ZRAN05	3500 CHIETI		60 X 6	C	10.5	32.0	600
ZRAN06	TIPO NUOVO		60 X 6	SQ	10.5	32.0	600

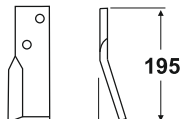
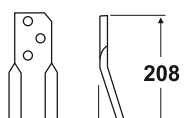
RENTER

ZRNT02	COLTELLO RTM - RTO		60 X 10	Y	14.5	37	880
ZRNT03	COLTELLO RTP - RTX		60 X 10	Y	14.5	32	910
ZRNT04	COLTELLO LR		60 X 8	Y	12.5	30	630

Tutti gli articoli sono di nostra produzione e non originali. Pesi e misure sono puramente indicativi e possono essere modificati senza preavviso. La riproduzione anche parziale del presente catalogo è vietata. All articles are of our production and not original. Weights and measures are approximate and may change without notice. Reproduction of this catalog is prohibited. Tous les articles sont fabriqués par nous-mêmes et non d'origine. Les poids et mesures sont approximatifs et peuvent changer sans préavis. Alle Artikel werden von uns selbst hergestellt und nicht original. Masse und Gewichte sind Richtwerte und können ohne Vorankündigung geändert werden.

Codice Code Ref. Re. Codigo	Marca e descrizione modello Brand name and model description Constructeur et description du modèle Marke und Modell Beschreibung Marca y modelo de descripción	Quote Dimensions Abmessungen Dimensiones 	Piatto Plate Platte Plaque 	Curvatura Curvature Corbure Krummung 	Foro Hole Trou Locher Hoyos Ø (mm)	Interasse Cent. Distance Achsenabstand Distancia entre ejes 	Peso Weight Gewicht Poids
---	--	---	---	---	---	--	--

RENTER

ZRNT05	COLTELLO RTG		60 X 12	Y	14.5	35	1200
--------	-----------------	--	---------	---	------	----	------

RINIERI

ZRIN02	ZAPPA		35 X 8	C	10.5	85.0	480
ZRIN03	ZAPPA		35 X 8	C	10.5	55.0	480

ROTECO

ZRTC01	MINITRISS CORTA		25 X 5	C Elicoidale	10.5	65	160
ZRTC02	MINITRISS		25 X 5	C Elicoidale	10.5	65	180
ZRTC03	110 D		30 X 6	C Elicoidale	10.5	66	290
ZRTC04	SUPERTRISS		35 X 5	C Elicoidale	10.5	65	300

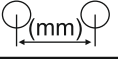
Codice Code Ref. Re. Codigo	Marca e descrizione modello Brand name and model description Constructeur et description du modèle Marke und Modell Beschreibung Marca y modelo de descripción	Quote Dimensions Abmessungen Dimensiones 	Piatto Plate Platte Plaque 	Curvatura Curvature Corbure Krummung 	Foro Hole Trou Locher Hoyos Ø (mm) 	Interasse Cent. Distance Achsenabstand Distancia entre ejes 	Peso Weight Gewicht Poids 
---	--	--	---	--	--	---	---

ROTECO

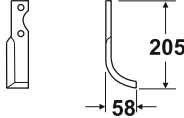
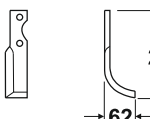
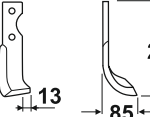
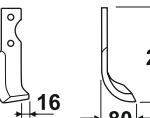
ZRTC05	SVAR		40 X 5	C	10.5	65	340
ZRTC06	310 -314		45 X 6	C	10.5	75	380
ZRTC07	HP 14 - 110 - 111 113 - 114 - 116		45 X 6	C Elicoidale	10.5	66	450
ZRTC08	MID - DURAN 114		45 X 6	C Elicoidale	10.5	75	450

SEP

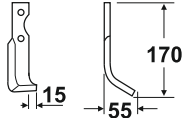
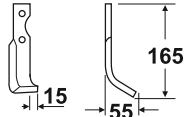
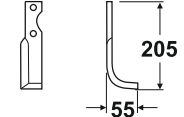
ZSEP01	SMART Cod Orig: 212090-91		25 X 5	C	8.5	55	170
ZSEP02	MOTOCOLTIVATORE 1000 Cod Orig: 210578-79		25 X 6	C	8.5	55	200
ZSEP04	S 506 Cod Orig: 220338-39		35 X 6	SQ	8.5	70	350

Tutti gli articoli sono di nostra produzione e non originali. Pesì e misure sono puramente indicativi e possono essere modificati senza preavviso. La riproduzione anche parziale del presente catalogo è vietata. All articles are of our production and not original. Weights and measures are approximate and may change without notice. Reproduction of this catalog is prohibited. Tous les articles sont fabriqués par nous-mêmes et non d'origine. Les poids et mesures sont approximatifs et peuvent changer sans préavis. Alle Artikel werden von uns selbst hergestellt und nicht original. Masse und Gewichte sind Richtwerte und können ohne Vorankündigung geändert werden.

Codice Code Ref. Re. Codigo	Marca e descrizione modello Brand name and model description Constructeur et description du modèle Marke und Modell Beschreibung Marca y modelo de descripción	Quote Dimensions Abmessungen Dimensiones 	Piatto Plate Platte Plaque 	Curvatura Curvature Corbure Krummung 	Foro Hole Trou Locher Hoyos Ø (mm)	Interasse Cent. Distance Achsenabstand Distancia entre ejes 	Peso Weight Gewicht Poids 
---	--	--	---	--	---	---	---

SEP

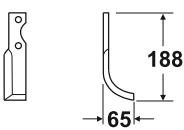
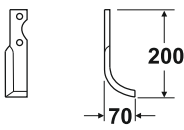
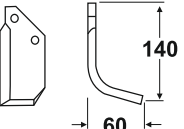
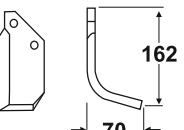
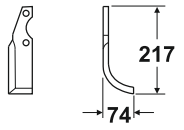
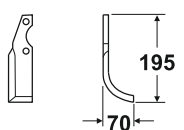
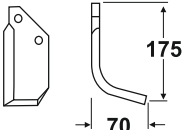
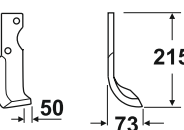
ZSEP05	MOTOZAPPA 35 - 40 - 50 - 90 Cod Orig: 209376-77		30 X 6	C	8.5	70	270
ZSEP06	MOTOZAPPA 60 - 70 - 100 - 1700 Cod Orig: 207843-44		35 X 6	C	10.5	70	360
ZSEP08	MOTOCOLTIVATORE 1300 - 1500 - 2000 REV Cod Orig: 106164-64		40 X 6	SSQ	10.5	27	450
ZSEP09	110 Diesel		45 X 6	SQ	10.5	30	450
ZSEP10	MOTOZAPPA 125 - 130 Cod Orig: 208062-63		45 X 6	C	10.5	70	480
ZSEP11	MOTOZAPPA 105 - 115 125 INTERNA Cod Orig: 210398-99		45 X 6	C	10.5	70	450
ZSEP12	MOTOZAPPA S 140 Cod Orig: 206448-49		50 X 6	SSQ	10.5	35	500
ZSEP13	S 506 - 113 Cod Orig: 215318-19		40 X 5	C Elicoidale	10.5	70	320

Tutti gli articoli sono di nostra produzione e non originali. Pesi e misure sono puramente indicativi e possono essere modificati senza preavviso. La riproduzione anche parziale del presente catalogo è vietata. All articles are of our production and not original. Weights and measures are approximate and may change without notice. Reproduction of this catalog is prohibited. Tous les articles sont fabriqués par nous-mêmes et non d'origine. Les poids et mesures sont approximatifs et peuvent changer sans préavis. Alle Artikel werden von uns selbst hergestellt und nicht original. Masse und Gewichte sind Richtwerte und können ohne Vorankündigung geändert werden.

Codice Code Ref. Re. Codigo	Marca e descrizione modello Brand name and model description Constructeur et description du modèle Marke und Modell Beschreibung Marca y modelo de descripción	Quote Dimensions Abmessungen Dimensiones 	Piatto Plate Platte Plaque 	Curvatura Curvature Corbure Krummung 	Foro Hole Trou Locher Hoyos Ø (mm)	Interasse Cent. Distance Achsenabstand Distancia entre ejes 	Peso Weight Gewicht Poids
---	--	---	---	---	---	--	--

SEP

ZSEP14	S 138 Cod Orig: 212416-17		50 X 6	C	10.5	73	500
ZSEP15	S 65 - 430 - 450 Cod Orig: 215667-68		40 X 4	C Elicoidale	8.5	70	280
ZSEP16	S 1400 - 1700		30 X 6	C Elicoidale	10.5	66	290

SICMA

ZSIC01	ZLL - SB - HL Cod Orig: 4811283-84		60 X 6	SQ Elicoidale	12.5	42	630
ZSIC02	ZLL - SB Cod Orig: 4811281-82		60 X 6	C Elicoidale	12.5	42	600
ZSIC03	SA Cod Orig: 4811680-81		60 X 6	C Elicoidale	12.5	40	560
ZSIC04	ST		80 X 7	SQ Elicoidale	14.5	50	980





Tutti gli articoli sono di nostra produzione e non originali. Pesi e misure sono puramente indicativi e possono essere modificati senza preavviso. La riproduzione anche parziale del presente catalogo è vietata. All articles are of our production and not original. Weights and measures are approximate and may change without notice. Reproduction of this catalog is prohibited. Tous les articles sont fabriqués par nous-mêmes et non d'origine. Les poids et mesurent approximatifs et peuvent changer sans préavis. Alle artikel werden von uns selbst hergestellt und nicht original. Masse und gewichte sind richtwerte und kan ohne vorank undigung gendert werden.

Codice Code Ref. Re. Codigo	Marca e descrizione modello Brand name and model description Constructeur et description du modèle Marke und Modell Beschreibung Marca y modelo de descripción	Quote Dimensions Abmessungen Dimensiones 	Piatto Plate Platte Plaque 	Curvatura Curvature Corbure Krummung 	Foro Hole Trou Locher Hoyos Ø (mm)	Interasse Cent. Distance Achsenabstand Distancia entre ejes 	Peso Weight Gewicht Poids
---	--	---	---	---	---	--	--

SICMA

ZSIC05	ST		80 X 7	C Elicoidale	14.5	50	930
ZSIC06	RMF - RM - SM Cod Orig: 4818224-25		80 X 7	SQ Elicoidale	14.5	55	950
ZSIC07	RMF - RM - SM Cod Orig: 4818222-23		80 X 7	C Elicoidale	14.5	55	950
ZSIC08	SP LUNGA		80 X 8	C Elicoidale	14.5	55	1300
ZSIC09	SP LUNGA		80 X 8	SQ Elicoidale	14.5	55	1350
ZSIC10	TLU		80 X 8	C Elicoidale	14.5	55	1040
ZSIC11	TLU		80 X 8	SQ	14.5	55	1180
ZSIC12	TCP PESANTE		80 X 8	C	14.5	60	1090

Tutti gli articoli sono di nostra produzione e non originali. Pesì e misure sono puramente indicativi e possono essere modificati senza preavviso. La riproduzione anche parziale del presente catalogo è vietata. All articles are of our production and not original. Weights and measures are approximate and may change without notice. Reproduction of this catalog is prohibited. Tous les articles sont fabriqués par nous-mêmes et non d'origine. Les poids et mesurés sont approximatifs et peuvent changer sans préavis. Alle artikel werden von uns selbst hergestellt und nicht original. Masse und gewichte sind richtwerte und kan ohne vorank undigung gendert werden.

Codice Code Ref. Re. Codigo	Marca e descrizione modello Brand name and model description Constructeur et description du modèle Marke und Modell Beschreibung Marca y modelo de descripción	Quote Dimensions Abmessungen Dimensiones 	Piatto Plate Platte Plaque  (mm)	Curvatura Curvature Corbure Krummung 	Foro Hole Trou Locher Hoyos Ø (mm)	Interasse Cent. Distance Achsenabstand Distancia entre ejes  (mm)	Peso Weight Gewicht Poids  gr
---	--	--	--	--	---	--	--

SICMA

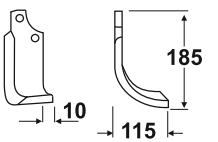
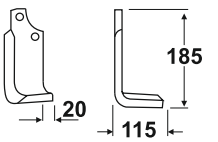
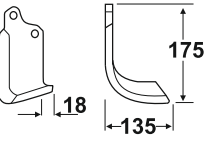
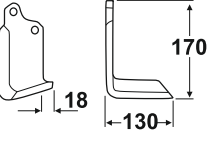
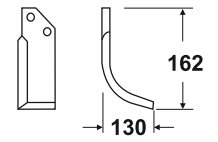
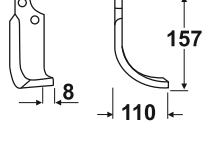
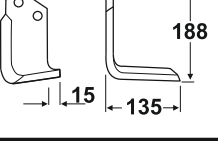
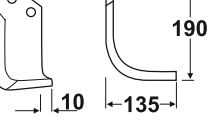
ZSIC13	CS - SF - CST - RC Cod Orig: 4811400-01		70 X 6	C	12.5	42	700
ZSIC14	CS - SF - RC Cod Orig: 4811402-03		70 X 6	SQ	12.5	42	750
ZSIC15	ST - SD - SH - RD Cod Orig: 4812425-26		80 X 7	C Elicoidale	14.5	55	980
ZSIC16	ST - SD - SH - RD Cod Orig: 4812427-28		80 X 7	SQ Elicoidale	14.5	55	1060
ZSIC17	BH - FLB - FLBR Cod Orig: 4811785-86		60 X 6	C	12.5	35	570
ZSIC18	HL Cod Orig: 4811285-86		60 X 6	C Elicoidale	12.5	42	550
ZSIC19	SPR - SP Cod Orig: 4814516-17		80 X 8	SQ Elicoidale	14.5	56	1160
ZSIC20	SPR - SP Cod Orig: 4814518-19		80 X 8	C Elicoidale	14.5	56	1120

Tutti gli articoli sono di nostra produzione e non originali. Pesi e misure sono puramente indicativi e possono essere modificati senza preavviso. La riproduzione anche parziale del presente catalogo è vietata. All articles are of our production and not original. Weights and measures are approximate and may change without notice. Reproduction of this catalog is prohibited. Tous les articles sont fabriqués par nous-même mes et non d'origine. Les poids et mesurssont approximatifs et peuvent changer sans preavis. Alle artikel werden von uns selbst hergestellt und nicht original. Masse und gewichte sind richtwerte und kan ohne vorank undigung gendert werden.

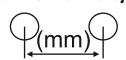
Codice Code Ref. Re. Codigo	Marca e descrizione modello Brand name and model description Constructeur et description du modèle Marke und Modell Beschreibung Marca y modelo de descripción	Quote Dimensions Abmessungen Dimensiones 	Piatto Plate Platte Plaque 	Curvatura Curvature Corbure Krummung 	Foro Hole Trou Locher Hoyos Ø (mm) 	Interasse Cent. Distance Achsenabstand Distancia entre ejes 	Peso Weight Gewicht Poids 
---	--	--	---	--	--	---	---

SICMA

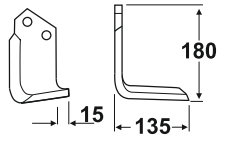
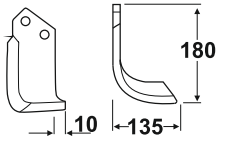
ZSIC21	RG Cod Orig: 4814002-03		90 X 8	SQ Elicoidale	14.5	56	1280
ZSIC22	RG Cod Orig: 4814004-05		90 X 8	C Elicoidale	14.5	56	1150

SOVEMA

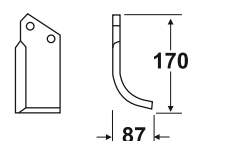
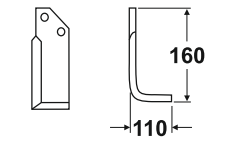
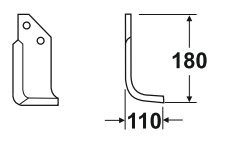
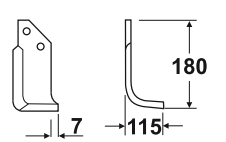
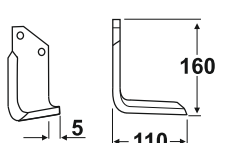
ZSOV01	TIPO LASER Cod Orig: 900111021-22		50 X 6	C	10.5	35	410
ZSOV02	TIPO RB Cod Orig: 900111019-20		60 X 6	SQ Elicoidale	12.5	46	650
ZSOV03	TIPO RB Cod Orig: 900111013-14		60 X 6	C Elicoidale	12.5	46	600
ZSOV04	TIPO RBS - SP - SPE SE - SEC - S - SPS Cod Orig: 900111001-02		70 X 7	C Elicoidale	12.5	46	800
ZSOV05	TIPO RBS - SP - SPE SE - SEC - S - SPS Cod Orig: 900111007-08		70 X 7	SQ Elicoidale	12.5	46	820

Codice Code Ref. Re. Codigo	Marca e descrizione modello Brand name and model description Constructeur et description du modèle Marke und Modell Beschreibung Marca y modelo de descripción	Quote Dimensions Abmessungen Dimensiones 	Piatto Plate Platte Plaque 	Curvatura Curvature Corbure Krummung 	Foro Hole Trou Locher Hoyos Ø (mm) 	Interasse Cent. Distance Achsenabstand Distancia entre ejes 	Peso Weight Gewicht Poids 
---	--	--	---	--	--	---	---

SOVEMA

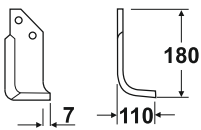
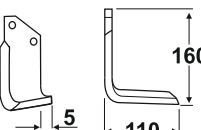
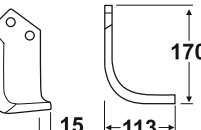
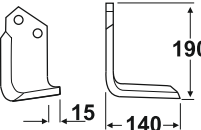
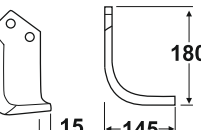
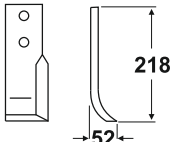
ZSOV06	TIPO SE - SEC - S - SPS Cod Orig: 900111003-04		70 X 7	C Elicoidale	14.5	46	800
ZSOV07	TIPO SE - SEC - S ST - STC Cod Orig: 900111009-10		70 X 7	SQ Elicoidale	14.5	46	800
ZSOV08	TIPO S - RE - REC ROC - ROM - RTX Cod Orig: 90011005-06		80 X 8	C Elicoidale	14.5	46	1050
ZSOV09	TIPO S - RE - REC ROC - ROM - RTX Cod Orig: 900111017-18		80 X 8	SQ Elicoidale	14.5	46	1180
ZSOV10	TIPO LUNGO Cod Orig: 900111023-24		80 X 8	C Elicoidale	14.5	46	1110
ZSOV11	COLTELLO		50 X 10	-	14.5	55	850

TORTELLA

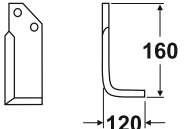
ZTOR01	SO - TO Cod Orig: 2985556-54		60 X 6	SQ	12.5	40	680
--------	---------------------------------	---	--------	----	------	----	-----

Codice Code Ref. Re. Codigo	Marca e descrizione modello Brand name and model description Constructeur et description du modèle Marke und Modell Beschreibung Marca y modelo de descripción	Quote Dimensions Abmessungen Dimensiones 	Piatto Plate Platte Plaque 	Curvatura Curvature Corbure Krummung 	Foro Hole Trou Locher Hoyos Ø (mm)	Interasse Cent. Distance Achsenabstand Distancia entre ejes 	Peso Weight Gewicht Poids
---	--	---	---	---	---	--	--

TORTELLA

ZTOR02	SO - TO Cod Orig: 2985550-52		60 X 6	C	12.5	40	610
ZTOR03	S1 - T2 - CLS Cod Orig: 2985600-02		70 X 7	C Elicoidale	12.5	42	800
ZTOR04	S1 - T2 - CLS Cod Orig: 2985604-06		70 X 7	SQ Elicoidale	12.5	42	840
ZTOR05	T 25 Cod Orig: 2985608-10		80 X 7	C Elicoidale	14.5	56	1000
ZTOR06	T 25		80 X 7	SQ Elicoidale	14.5	55	1110
ZTOR07	T 45 - T 5 Cod Orig: 2985314-16		80 X 8	SQ	14.5	59	1220
ZTOR08	T 3 - T 4 Cod Orig: 2985214-16		80 X 8	SQ Elicoidale	14.5	55	1220
ZTOR09	T 3 - T 4 Cod Orig: 2985204-06		80 X 8	C Elicoidale	14.5	55	1080

Codice Code Ref. Re. Codigo	Marca e descrizione modello Brand name and model description Constructeur et description du modèle Marke und Modell Beschreibung Marca y modelo de descripción	Quote Dimensions Abmessungen Dimensiones 	Piatto Plate Platte Plaque 	Curvatura Curvature Corbure Krummung 	Foro Hole Trou Locher Hoyos Ø (mm)	Interasse Cent. Distance Achsenabstand Distancia entre ejes 	Peso Weight Gewicht Poids
---	--	---	---	---	---	--	--

TORTELLA

ZTOR10	T 45 - T 5 Cod Orig: 2985304-06		80 X 8	C Elicoidale	14.5	59	1200
ZTOR11	CP Cod Orig: 2915		80 X 8	C	14.5	59	1170
ZTOR12	T 5 - T 6 3 FORI Cod Orig: 2985500-02		90 X 10	C	14.5	40 - 40	2000
ZTOR13	LAMA FRANGOR		50 X 12	D	16.5	45	800

VALENTINI

ZVLN01	ZAPPA MS - ER Cod Orig: 41011400		90 X 8	C Elicoidale	16.5	56	1500
ZVLN02	ZAPPA MS - ER Cod Orig: 1MS000305-06		90 X 10	C Elicoidale	16.5	56	1620
ZVLN03	ZAPPA		80 X 8	C Elicoidale	14.5	56	1230

Tutti gli articoli sono di nostra produzione e non originali. Pesi e misure sono puramente indicativi e possono essere modificati senza preavviso. La riproduzione anche parziale del presente catalogo è vietata. All articles are of our production and not original. Weights and measures are approximate and may change without notice. Reproduction of this catalog is prohibited. Tous les articles sont fabriqués par nous-mêmes et non d'origine. Les poids et mesures sont approximatifs et peuvent changer sans préavis. Alle Artikel werden von uns selbst hergestellt und nicht original. Masse und Gewichte sind Richtwerte und können ohne Vorankündigung geändert werden.

Codice Code Ref. Re. Codigo	Marca e descrizione modello Brand name and model description Constructeur et description du modèle Marke und Modell Beschreibung Marca y modelo de descripción	Quote Dimensions Abmessungen Dimensiones 	Piatto Plate Platte Plaque 	Curvatura Curvature Corbure Krummung 	Foro Hole Trou Locher Hoyos Ø (mm)	Interasse Cent. Distance Achsenabstand Distancia entre ejes 	Peso Weight Gewicht Poids
---	--	---	---	---	---	--	--

VALENTINI

ZVLN04	INTERRASASSI CORTO Cod Orig: 8RD000126-27		90 X 12	-	16.5	57	1600
ZVLN05	ZAPPETTA MS - ER		90 X 10	SQ Elicoidale	16.5	56	2050
ZVLN06	INTERRASASSI LUNGO		90 X 10	-	14.5	57	1560
ZVLN07	INTERRASASSI LUNGO		90 X 12	-	16.5	57	1860
ZVLN08	INTERRASASSI		90 X 10	-	14.5	57	1350
ZVLN09	COLTELLO MS - ER - JG - SQ Cod Orig: 1MS000481-82		90 X 10	D	16.5	56	980
ZVLN10	INTERRASASSI Cod Orig: ST004545316-17		60 X 8	-	12.5	44	650
ZVLN11	COLTELLO LAMA Cod Orig: 1SQ000362-63		60 X 12	Y	16.5	45	1500

Codice Code Ref. Re. Codigo	Marca e descrizione modello Brand name and model description Constructeur et description du modèle Marke und Modell Beschreibung Marca y modelo de descripción	Quote Dimensions Abmessungen Dimensiones 	Piatto Plate Platte Plaque 	Curvatura Curvature Corbure Krummung 	Foro Hole Trou Locher Hoyos Ø (mm)	Interasse Cent. Distance Achsenabstand Distancia entre ejes 	Peso Weight Gewicht Poids
---	--	---	---	---	---	--	--

VALENTINI

ZVLN12	ZAPPA Cod Orig: 1SQ000301-02		80 X 8	SQ Elicoidale	14.5	56	1400
ZVLN13	MS - ER Cod Orig: 0041011422		90 X 9	C Elicoidale	16.5	56	1450
ZVLN14	LAMA ERCULES Cod Orig: 1MS000141-42		60 X 12	Y	16.5	45	1300
ZVLN16	ZAPPETTA MS - ER		90 X 9	SQ Elicoidale	16.5	56	1450

VALPADANA

ZVAL01	BIETOLE 4 RM		35 X 6	C	8.5	70	290
ZVAL02	VMC 140 - 130 BLITZ 70 - 80 Cod Orig: 115915-16		35 X 6	C Elicoidale	10.5	70	350
ZVAL03	VMC 8 - 110 - 130		40 X 6	SQ	10.5	27	320

Tutti gli articoli sono di nostra produzione e non originali. Pesì e misure sono puramente indicativi e possono essere modificati senza preavviso. La riproduzione anche parziale del presente catalogo è vietata. All articles are of our production and not original. Weights and measures are approximate and may change without notice. Reproduction of this catalog is prohibited. Tous les articles sont fabriqués par nous-mêmes et non d'origine. Les poids et mesures sont approximatifs et peuvent changer sans préavis. Alle Artikel werden von uns selbst hergestellt und nicht original. Masse und Gewichte sind Richtwerte und können ohne Vorankündigung geändert werden.

Codice Code Ref. Re. Codigo	Marca e descrizione modello Brand name and model description Constructeur et description du modèle Marke und Modell Beschreibung Marca y modelo de descripción	Quote Dimensions Abmessungen Dimensiones 	Piatto Plate Platte Plaque 	Curvatura Curvature Corbure Krummung 	Foro Hole Trou Locher Hoyos Ø (mm)	Interasse Cent. Distance Achsenabstand Distancia entre ejes 	Peso Weight Gewicht Poids 
---	--	--	---	--	---	---	---

VALPADANA

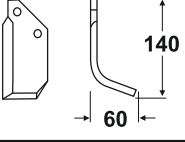
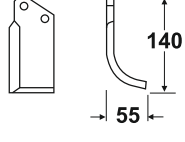
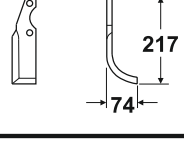
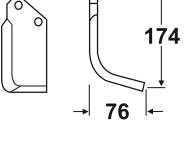
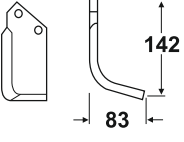
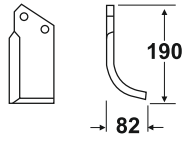
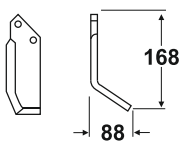
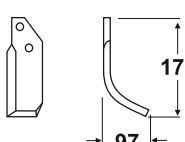

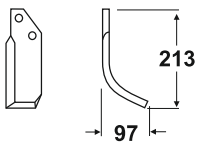
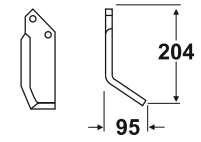
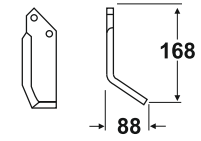
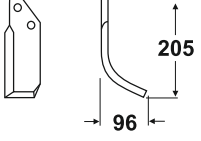
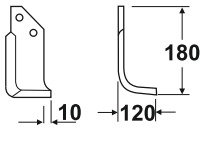
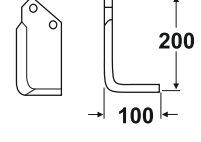
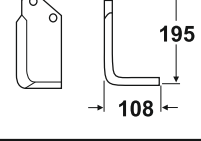
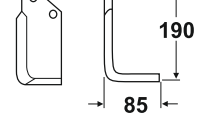

ZVAL04	VMC 130		40 X 6	SQ	10.5	27	280
ZVAL05	VMC 8 - 110 - 130		40 X 6	C	10.5	27	250
ZVAL06	VMC 150 BLITZ 120		45 X 6	C	10.5	70	450
ZVAL07	VMC 14 - 160 BLITZ 150		50 X 6	C	10.5	35	410
ZVAL08	VMC 10 - 12 S 140		50 X 6	C	10.5	35	400
ZVAL09	VMC 15		50 X 6	C	10.5	35	440
ZVAL10	VMC 14		50 X 6	SQ	10.5	35	430
ZVAL11	4 RM - 180		60 X 6	C	10.5	42	560

Codice Code Ref. Re. Codigo	Marca e descrizione modello Brand name and model description Constructeur et description du modèle Marke und Modell Beschreibung Marca y modelo de descripción	Quote Dimensions Abmessungen Dimensiones 	Piatto Plate Platte Plaque 	Curvatura Curvature Corbure Krummung 	Foro Hole Trou Locher Hoyos Ø (mm)	Interasse Cent. Distance Achsenabstand Distancia entre ejes 	Peso Weight Gewicht Poids 
---	--	--	---	--	---	---	---

VALPADANA

ZVAL12	VMC 18 TIPO NUOVO		60 X 6	C	10.5	45	640
ZVAL13	VMC 18 - 4 RM 20		60 X 6	SQ	10.5	45	700
ZVAL14	VMC 14		60 X 6	SQ	10.5	35	570
ZVAL15	VMC 18		60 X 6	C	10.5	45	600
ZVAL17	4 RM 300 - 400 - 450		70 X 6	C Elicoidale	12.5	40	680
ZVAL18	VFC		70 X 6	SQ	12.5	40	800
ZVAL19	4 RM - 180		60 X 6	SQ	10.5	42	700
ZVAL21	VMC14 TIPO REGGIO		60 X 6	SQ	10.5	35	620

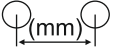
Tutti gli articoli sono di nostra produzione e non originali. Pesi e misure sono puramente indicativi e possono essere modificati senza preavviso. La riproduzione anche parziale del presente catalogo è vietata. All articles are of our production and not original. Weights and measures are approximate and may change without notice. Reproduction of this catalog is prohibited. Tous les articles sont fabriqués par nous-même mes et non d'origine. Les poids et mesurent approximatifs et peuvent changer sans preavis. Alle artikel werden von uns selbst hergestellt und nicht original. Masse und gewichte sind richtwerte und kan ohne vorank undigung gendert werden.

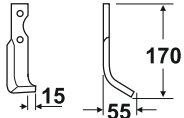
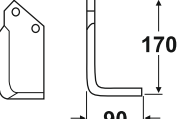
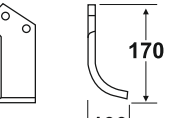
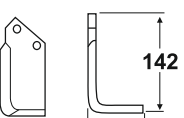

Codice Code Ref. Re. Codigo	Marca e descrizione modello Brand name and model description Constructeur et description du modèle Marke und Modell Beschreibung Marca y modelo de descripción	Quote Dimensions Abmessungen Dimensiones 	Piatto Plate Platte Plaque 	Curvatura Curvature Corbure Krummung 	Foro Hole Trou Locher Hoyos Ø (mm)	Interasse Cent. Distance Achsenabstand Distancia entre ejes 	Peso Weight Gewicht Poids 
---	--	--	---	--	---	---	---

VALPADANA

ZVAL22	BLITZ 50		25 X 5	C Elicoidale	8.5	55	170
ZVAL23	VMC 14 MAGGIORATA TIPO ISCHIA		60 X 6	SQ	10.5	35	580
ZVAL24	VMC 14 MAGGIORATA TIPO ISCHIA		60 X 6	C	10.5	35	600
ZVAL25	VMC 10 - 12		50 X 6	SQ	10.5	35	430

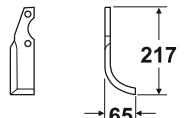
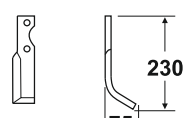
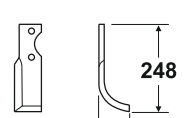
VENTRUCCI

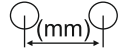
ZVEN01	HP 8		45 X 5	C Elicoidale	10.5	66	500
ZVEN02	HP 10		40 X 6	SSQ	10.5	85	450
ZVEN03	HP 14		50 X 6	SSQ	10.5	85	700

Codice Code Ref. Re. Codigo	Marca e descrizione modello Brand name and model description Constructeur et description du modèle Marke und Modell Beschreibung Marca y modelo de descripción	Quote Dimensions Abmessungen Dimensiones 	Piatto Plate Platte Plaque 	Curvatura Curvature Corbure Krummung 	Foro Hole Trou Locher Hoyos Ø (mm)	Interasse Cent. Distance Achsenabstand Distancia entre ejes 	Peso Weight Gewicht Poids 
---	--	--	---	--	---	---	---

VIGOLO

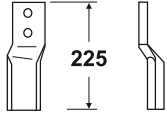
ZVIG01	DENTE FRANGOR		70 X 10	D	14.5	50	1040
--------	---------------	---	---------	---	------	----	------

YANMAR

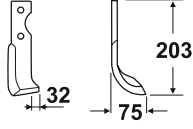
ZYNM01	322 - 682		35 X 6	C Elicoidale	10.5	70	420
--------	-----------	---	--------	-----------------	------	----	-----

AGGIORNAMENTI

Tutti gli articoli sono di nostra produzione e non originali. Pesi e misure sono puramente indicativi e possono essere modificati senza preavviso. La riproduzione anche parziale del presente catalogo è vietata. All articles are of our production and not original. Weights and measures are approximate and may change without notice. Reproduction of this catalog is prohibited. Tous les articles sont fabriqués par nous-mêmes et non d'origine. Les poids et mesures sont approximatifs et peuvent changer sans préavis. Alle artikel werden von uns selbst hergestellt und nicht original. Masse und gewichte sind richtwerte und kan ohne vorank undigung gendert werden.