



# COLTELLI SCAVAFOSSI

BLADES FOR TRENCHERS

COUTEAUX POUR CREUSER LES FOSSÈS

MESSER FÜR GRABENFRASEN - CUCHILLOS PARA ZANJADORAS

# SCAMAFOSI

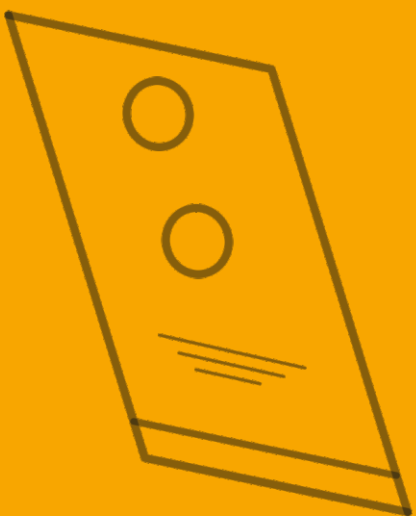

# COLTELLI SCAVAFOSSI



BLADES FOR TRENCHERS - COUTEAUX POUR CREUSER LES FOSSÉS  
MESSER FÜR GRABENFRASEN - CUCHILLOS PARA ZANJADORAS

Codice Ref. Re. Codigo	Marca e descrizione modello Brand name and model description Constructeur et description du modèle Marke und Modell Beschreibung Marca y modelo de descripción	Quote/ Dimensions Abmessungen Dimensiones (mm) 	Piatto Plate Platte Plaque 	Curvatura Curvature Corbure Krummung 	Foro Hole Trou Locher Hoyos Ø (mm)	Interasse Cent. Distance Achsenabstand Distancia entre ejes 	Peso Weight Gewicht Poids 
---------------------------------	--	--	---	---	---	--	--

## BREVIGLIERI

SBRE01	PIASTRINA		60 X 10	-	12.5	50	560
SBRE02	COLTELLO ESTERNO LUNGO		60 X 10	-	12.5	55	1160
SBRE03	ANGOLARE INTERNO SX		90 X 8	-	14.5	65	1000

## COSMECO

SCOS01	COLTELLO ESTERNO LUNGO 201 - 221 - 261 M 111		60 X 10	-	12.5	55	1160
SCOS02	PIASTRINA 201 - 221 - 261 M 111		60 X 10	-	12.5	55	560

## DAVIS







SDAV01	SCAFAFOSSI TAGLIASTRADA		90 X 10	-	16.5	50	560
--------	----------------------------	--	---------	---	------	----	-----

Tutti gli articoli sono di nostra produzione e non originali. Pesi e misure sono puramente indicativi e possono essere modificati senza preavviso. La riproduzione anche parziale del presente catalogo è vietata. All articles are of our production and not original. Weights and measures are approximate and may change without notice. Reproduction of this catalog is prohibited. Tous les articles sont fabriqués par nous-mêmes et non d'origine. Les poids et mesurent approximatifs et peuvent changer sans préavis. Alle artikel werden von uns selbst hergestellt und nicht original. Masse und gewichte sind richtwerte und kan ohne vorank undigung gendert werden.

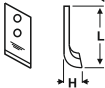
# COLTELLI SCAVAFOSSI





BLADES FOR TRENCHERS - COUTEAUX POUR CREUSER LES FOSSÉS  
MESSER FÜR GRABENFRASEN - CUCHILLOS PARA ZANJADORAS

Codice Ref. Re. Codigo	Marca e descrizione modello Brand name and model description Constructeur et description du modèle Marke und Modell Beschreibung Marca y modelo de descripción	Quote/ Dimensions Abmessungen Dimensiones (mm) 	Piatto Plate Platte Plaque 	Curvatura Curvature Corbure Krummung 	Foro Hole Trou Locher Hoyos Ø (mm) 	Interasse Cent. Distance Achsenabstand Distancia entre ejes 	Peso Weight Gewicht Poids 
---------------------------------	--	---	---	--	--	---	---

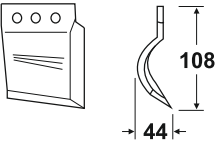
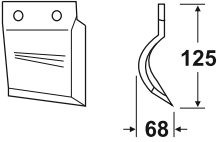
## DAVIS

SDAV02	SCAFAFOSSI TAGLIASTRADA 3 FORI		70 X 6	-	10.5	25 - 41	400
SDAV03	SCAFAFOSSI TAGLIASTRADA		90 X 8	-	16.5	50	1000

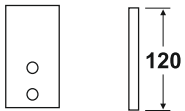
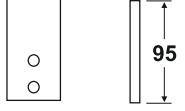
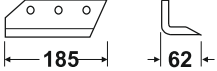
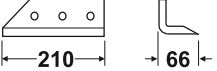
## DONDI

SDON01	DENTE DMR 45 - 65 75 - 90 - 95		60 X 12	-	12.5	50	650
SDON02	DENTE DMR 25 - 35		50 X 10	-	10.5	30	330
SDON03	COLTELLO INTERNO DMR 25 - 35		90 X 8	-	12.5	50	850
SDON04	COLTELLO ESTERNO DMR 25 - 35 DESTRO		90 X 8	-	12.5	50	1030
SDON04S	COLTELLO ESTERNO DMR 25 - 35 SINISTRO		90 X 8	-	12.5	50	1030

Tutti gli articoli sono di nostra produzione e non originali. Pesi e misure sono puramente indicativi e possono essere modificati senza preavviso. La riproduzione anche parziale del presente catalogo è vietata. All articles are of our production and not original. Weights and measures are approximate and may change without notice. Reproduction of this catalog is prohibited. Tous les articles sont fabriqués par nous-mêmes et non d'origine. Les poids et mesures sont approximatifs et peuvent changer sans préavis. Alle artikel werden von uns selbst hergestellt und nicht original. Masse und gewichte sind richtwerte und kan ohne vorank undigung gendert werden.

# COLTELLI SCAVAFOSSE



BLADES FOR TRENCHERS - COUTEAUX POUR CREUSER LES FOSSES  
MESSER FÜR GRABENFRASEN - CUCHILLOS PARA ZANJADORAS

Codice Ref. Re. Codigo	Marca e descrizione modello Brand name and model description Constructeur et description du modèle Marke und Modell Beschreibung Marca y modelo de descripción	Quote/ Dimensions Abmessungen Dimensiones (mm) 	Piatto Plate Platte Plaque 	Curvatura Curvature Corbure Krummung 	Foro Hole Trou Locher Hoyos Ø (mm)	Interasse Cent. Distance Achsenabstand Distancia entre ejes 	Peso Weight Gewicht Poids 
---------------------------------	--	--	---	---	---	--	--

## DONDI

SDON05	COLTELLO ESTERNO DMR 45 - 55		90 X 8	-	14.5	65	1000
SDON06	COLTELLO ESTERNO DMR 45 - 55 - 65 - 75 DESTRO		110 X 10	-	14.5	60	1650
SDON06S	COLTELLO ESTERNO DMR 65 - 75 SINISTRO		100 X 8	-	14.5	60	1650
SDON07	COLTELLO INTERNO DMR 65		100 X 8	-	14.5	65	1380
SDON08	COLTELLO ESTERNO DMR 65 DBR 90 - 95 DESTRO		100 X 8	-	14.5	60	1800
SDON08S	COLTELLO ESTERNO DMR 65 DBR 90 - 95 SINISTRO		100 X 8	-	14.5	60	1800
SDON09	COLTELLO DISCO DMR 25 - 45		80 X 7	-	12.5	60	760
SDON10	COLTELLO DRENAG		70 X 10	-	14.5	50 - 56	1500

Tutti gli articoli sono di nostra produzione e non originali. Pesì e misure sono puramente indicativi e possono essere modificati senza preavviso. La riproduzione anche parziale del presente catalogo è vietata. All articles are of our production and not original. Weights and measures are approximate and may change without notice. Reproduction of this catalog is prohibited. Tous les articles sont fabriqués par nous-mêmes et non d'origine. Les poids et mesures sont approximatifs et peuvent changer sans préavis. Alle Artikel werden von uns selbst hergestellt und nicht original. Masse und Gewichte sind Richtwerte und können ohne Vorankündigung geändert werden.

# COLTELLI SCAVAFOSSI



BLADES FOR TRENCHERS - COUTEAUX POUR CREUSER LES FOSSÉS  
MESSER FÜR GRABENFRASEN - CUCHILLOS PARA ZANJADORAS

Codice Ref. Re. Codigo	Marca e descrizione modello Brand name and model description Constructeur et description du modèle Marke und Modell Beschreibung Marca y modelo de descripción	Quote/ Dimensions Abmessungen Dimensiones (mm) 	Piatto Plate Platte Plaque 	Curvatura Curvature Corbure Krummung 	Foro Hole Trou Locher Hoyos Ø (mm)	Interasse Cent. Distance Achsenabstand Distancia entre ejes 	Peso Weight Gewicht Poids 
---------------------------------	--	--	---	---	---	--	--

## DONDI

SDON11	<b>ANGOLARE D45B DESTRO D45C SINISTRO</b>		90 X 8	-	12.5	50	920
SDON12	<b>DENTE PIEGATO</b> Cod Orig: 607044/45		60 X 10	-	10.5	30	260
SDON13	<b>DENTE PIEGATO DBR</b> Cod Orig: 607040/41		70 X 12	-	12.5	50	360
SDON14R	<b>ANGOLARE ESTERNO S 25/C DESTRO</b>		100 X 8	-	12.5	50	1030
SDON14L	<b>ANGOLARE ESTERNO S 25/C SINISTRO</b>		100 X 8	-	12.5	50	1030

## MALETTI KVERNELAND

SMAL01	<b>ZAPPINA N° 1 AFR/O - AFR2R</b> Cod Orig: 3000071		40 X 10	-	12.5	27	230
SMAL02	<b>ZAPPINA N° 2 AFR/O - AFR2R</b> Cod Orig: 3000072		40 X 10	-	12.5	27	240

Tutti gli articoli sono di nostra produzione e non originali. Pesi e misure sono puramente indicativi e possono essere modificati senza preavviso. La riproduzione anche parziale del presente catalogo è vietata. All articles are of our production and not original. Weights and measures are approximate and may change without notice. Reproduction of this catalog is prohibited. Tous les articles sont fabriqués par nous-mêmes et non d'origine. Les poids et mesures sont approximatifs et peuvent changer sans préavis. Alle artikel werden von uns selbst hergestellt und nicht original. Masse und gewichte sind richtwerte und kan ohne vorank undigung gendert werden.

Codice Ref. Re. Codigo	Marca e descrizione modello Brand name and model description Constructeur et description du modèle Marke und Modell Beschreibung Marca y modelo de descripción	Quote/ Dimensions Abmessungen Dimensiones (mm) 	Piatto Plate Platte Plaque 	Curvatura Curvature Corbure Krummung 	Foro Hole Trou Locher Hoyos Ø (mm)	Interasse Cent. Distance Achsenabstand Distancia entre ejes 	Peso Weight Gewicht Poids 
------------------------	--	--	---	---	---	--	--

## MALETTI KVERNELAND

SMAL03	ZAPPINA N° 3 AFR/O - AFR2R Cod Orig: 3000073		40 X 10	-	12.5	27	270
SMAL04	ZAPPINA N° 4 AFR/O - AFR2R Cod Orig: 3000074		40 X 10	-	12.5	27	250
SMAL05	ZAPPINA N° 5 AFR/O - AFR2R		40 X 10	-	12.5	27	270
SMAL06	COLTELLO LATERALE AFR/O Cod Orig: 3000082		60 X 10	-	14.5	60	890
SMAL07	COLTELLO LATERALE BIRUOTA DESTRO Cod Orig: 3900081		70 X 10	-	14.5	50	600
SMAL08	ZAPPINA AFR 60 Cod Orig: 4201071/72		70 X 12	-	14.5	30	550
SMAL09	ZAPPINA AFR - 2G Cod Orig: 3600071/72		70 X 10	-	14.5	30	600
SMAL10	ANGOLARE 6 FORI AFR/2 - AFR/4R Cod Orig:		100 X 10	-	14.5	75	1900

# COLTELLI SCAVAFOSSI



BLADES FOR TRENCHERS - COUTEAUX POUR CREUSER LES FOSSÉS  
MESSER FÜR GRABENFRASEN - CUCHILLOS PARA ZANJADORAS

Codice Ref. Re. Codigo	Marca e descrizione modello Brand name and model description Constructeur et description du modèle Marke und Modell Beschreibung Marca y modelo de descripción	Quote/ Dimensions Abmessungen Dimensiones (mm) 	Piatto Plate Platte Plaque 	Curvatura Curvature Corbure Krummung 	Foro Hole Trou Locher Hoyos Ø (mm)	Interasse Cent. Distance Achsenabstand Distancia entre ejes 	Peso Weight Gewicht Poids 
---------------------------------	--	--	---	---	---	--	--

## MALETTI KVERNELAND

SMAL11	<b>ANGOLARE 6 FORI</b> AFR/OS - AFR/OS - 3C Cod Orig: 3200081		100 X 10	-	14.5	88	1900
--------	---	--	----------	---	------	----	------

## PALMESE

SPLM01	<b>PUNTALE SCAVAPATATE 4 FORI</b>		120 X 10	-	-	50 - 65	2950
SPLM02	<b>PUNTALE SCAVAPATATE</b>		120 X 10	-	13.5	108	3000
SPLM03	<b>PUNTALE SCAVAPATATE</b>		100 X 8	-	13.5	50	1700
SPLM04	<b>SCAVAFOSI TAGLIASTRADA</b>		130 X 10	-	19	75	1600
SPLM04R	<b>SCAVAFOSI TAGLIASTRADA CON RIPOSTO AL TUNGSTENO</b>		130 X 10	-	19	75	1680
SPLM08	<b>PUNTALE SCAVAPATATE 3 FORI</b>		120 X 10	-	13	76 - 90	3250





Tutti gli articoli sono di nostra produzione e non originali. Pesi e misure sono puramente indicativi e possono essere modificati senza preavviso. La riproduzione anche parziale del presente catalogo è vietata. All articles are of our production and not original. Weights and measures are approximate and may change without notice. Reproduction of this catalog is prohibited. Tous les articles sont fabriqués par nous-mêmes et non d'origine. Les poids et mesures sont approximatifs et peuvent changer sans préavis. Alle Artikel werden von uns selbst hergestellt und nicht original. Masse und Gewichte sind Richtwerte und können ohne Vorankündigung geändert werden.



# COLTELLI SCAVAFOSSE

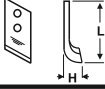

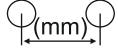
BLADES FOR TRENCHERS - COUTEAUX POUR CREUSER LES FOSSÈS  
 MESSER FÜR GRABENFRASEN - CUCHILLOS PARA ZANJADORAS

Codice Ref. Re. Codigo	Marca e descrizione modello Brand name and model description Constructeur et description du modèle Marke und Modell Beschreibung Marca y modelo de descripción	Quote/ Dimensions Abmessungen Dimensiones (mm) 	Piatto Plate Platte Plaque 	Curvatura Curvature Corbure Krummung 	Foro Hole Trou Locher Hoyos Ø (mm)	Interasse Cent. Distance Achsenabstand Distancia entre ejes 	Peso Weight Gewicht Poids 
---------------------------------	--	---	---	--	---	---	---

## AGGIORNAMENTI

				-			
				-			
				-			
				-			
				-			
				-			
				-			
				-			
				-			

Tutti gli articoli sono di nostra produzione e non originali. Pesi e misure sono puramente indicativi e possono essere modificati senza preavviso. La riproduzione anche parziale del presente catalogo è vietata. All articles are of our production and not original. Weights and measures are approximate and may change without notice. Reproduction of this catalog is prohibited. Tous les articles sont fabriqués par nous-même et non d'origine. Les poids et mesurés sont approximatifs et peuvent changer sans préavis. Alle artikel werden von uns selbst hergestellt und nicht original. Masse und gewichte sind richtwerte und kan ohne vorank undigung gendert werden.